

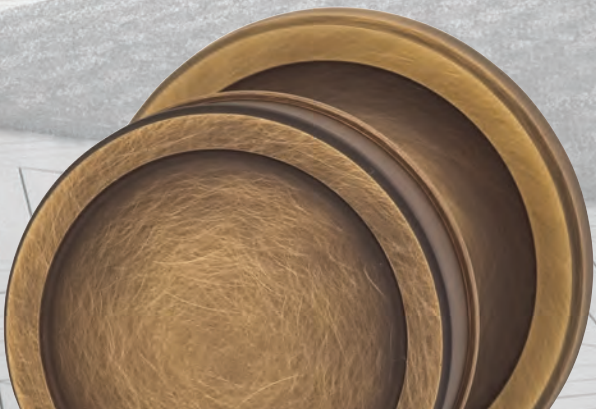

OMNIA



ARC



SINCE  
1964

## BEADED

### 508BD50

WILL NOT FIT 2 1/8" BORE.

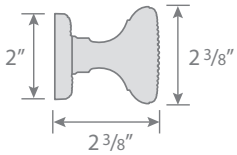

PA/PR \$244  
SD \$120

### 508BD67

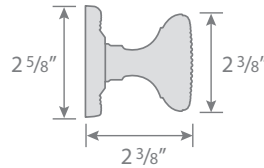

PA/PR \$244  
SD \$120

## MILLED

### 511ML50

WILL NOT FIT 2 1/8" BORE.

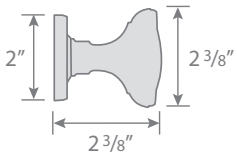

PA/PR \$244  
SD \$120

### 511ML67

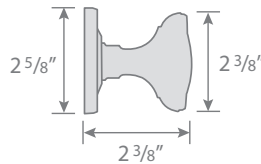

PA/PR \$244  
SD \$120

## EDGED

### 513ED50

WILL NOT FIT 2 1/8" BORE.

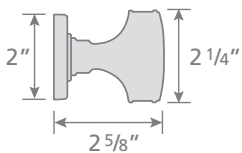

PA/PR \$244  
SD \$120

### 513ED67

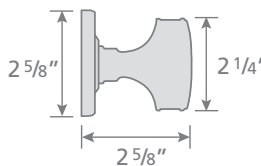

PA/PR \$244  
SD \$120

PA/PR = Passage/Privacy • SD = Single Dummy

FINISHES: US3, US3A, US4, US5, US10B, US14, US15, US26

## BEADED

### 748BD50

WILL NOT FIT 2 1/8" BORE.

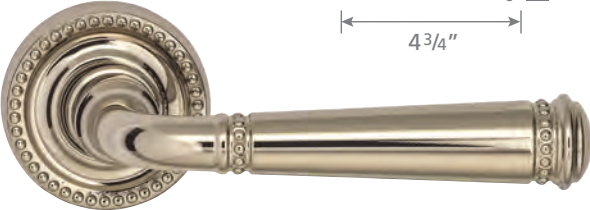
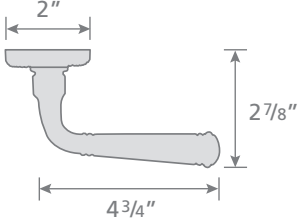

PA/PR \$244  
SD \$120

### 748BD67

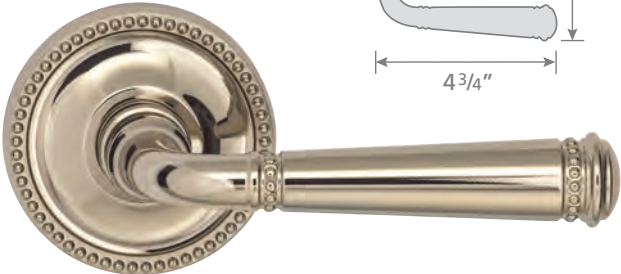
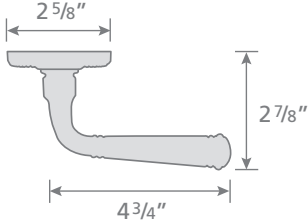

PA/PR \$244  
SD \$120

## MILLED

### 751ML50

WILL NOT FIT 2 1/8" BORE.

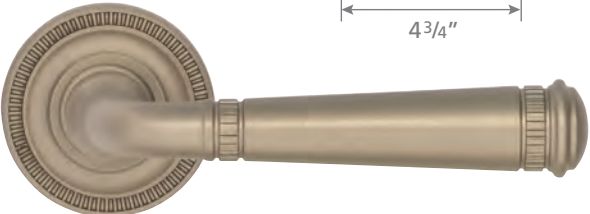
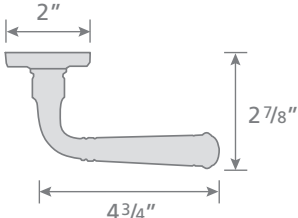

PA/PR \$244  
SD \$120

### 751ML67

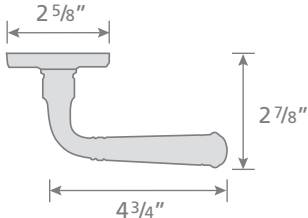

PA/PR \$244  
SD \$120

## EDGED

### 753ED50

WILL NOT FIT 2 1/8" BORE.

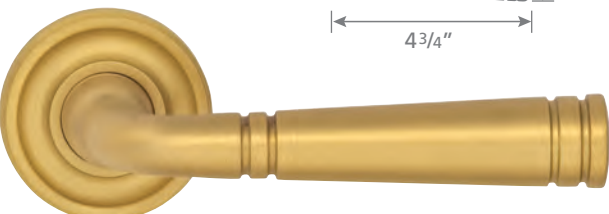
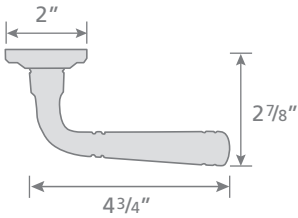

PA/PR \$244  
SD \$120

### 753ED67

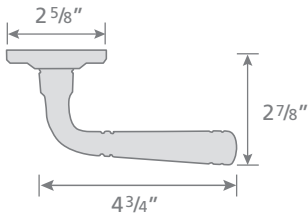

PA/PR \$244  
SD \$120

# OMNIA ARC

## How to Order

EXAMPLE	Design	Rose Option	Rose Size	Latch	Strike	Function	Finish
	<b>751</b>	<b>ED</b>	<b>50</b>	<b>238</b>	<b>F</b>	<b>PA</b>	<b>15</b>
		BD = Beaded ED = Edged ML = Milled	50 = 50 mm 67 = 67 mm	238 = 2 3/8" Backset 234 = 2 3/4" Backset 0 = Single Dummy	T = "T" Strike F = Full Lip Strike	See Function Codes Below*	See Finish Codes Below**

Example product order number would be **751ED50/238F.PA15**

## Product Data

### Knob and Lever Latchset

- 2 3/8" (standard) and 2 3/4" backsets available.
- Supplied for 1 3/8" door thickness as standard. The minimum door thickness is 1 1/4"; the maximum door thickness is 2 1/2" (please specify).
- All lever latchsets meet ADA accessibility requirements.

Each set consists of solid brass knobs or levers, concealed screw finished roses, metal thru-bolting spring-assisted rose cassette, latch, strike, dust box, faceplate, spindle, all necessary mounting screws, installation template and instructions.



Latchsets with any of the smaller roses are available with a push-button privacy function just like the larger roses.

### About Our Tubular Latch

- 28° rotation to retract latch.
- Tough, non-rusting materials used throughout. Face covers and strikes are solid brass. No.013 "T" strike supplied as standard or No.014 "Full Lip" strike as an option. (Please specify.)
- Critical interior parts are made of solid brass.
- For over five decades, OMNIA's latches have been opening and closing millions of doors all around the world.

### Function Codes\*

- **PA = Passage:** Latch operates by knob or lever from either side of door.
- **PR = Privacy:** Push pin provided for privacy inside room. Emergency release hole for outside room. Emergency release key also provided.
- **SD = Single Dummy:** Trim on one side of door only. Concealed screw roses for surface mounting. Knob or lever with rose.

## FINISH CODES\*\*



## Latchset Component List

- |  |  |
|--|--|
| A - Door Knob/Lever (2)                                    | N - Thru-Bolt Machine Screws With Locking Washer (2) |
| B - Set Screw (2)  | O - Washer Installation Tool                         |
| C - Nylon Threaded Washer (2)                              | P - Privacy Locking Pin (For Privacy ONLY)           |
| D - Finished Rose (2)                                      | Q - Emergency Release Key                            |
| Ea - Metal Spring Assist Sub-Rose                          |  |
| Eb - Metal Spring Assist Sub-Rose                          |  |
| F - Spindle (Teardrop groove positioned towards set screw) |  |
| G - Tubular Latch  |  |
| H - Privacy Locking Block Machine Screw                    |  |
| I - Privacy Locking Block Locking Stopper                  |  |
| J - Privacy Locking Block                                  |  |
| K - Tubular Latch Faceplate                                |  |
| L - Tubular Latch Strike Plate                             |  |
| M - Tubular Latch Dust Box                                 |  |

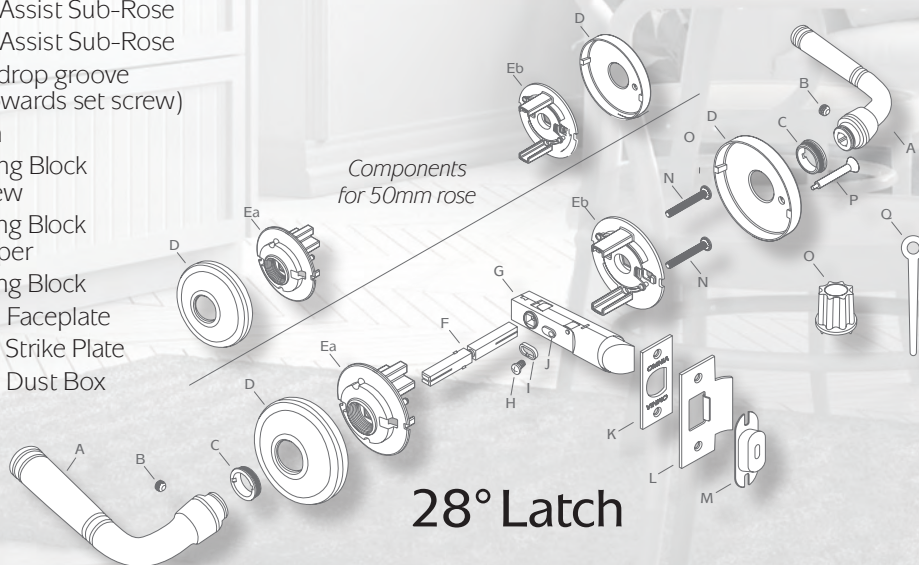

28° Latch

**SMALL ROSES WILL NOT FIT 2 1/8" BORE.**

ALL ROSES ARE CONCEALED SCREW MOUNTED.