

MAIN BEAM

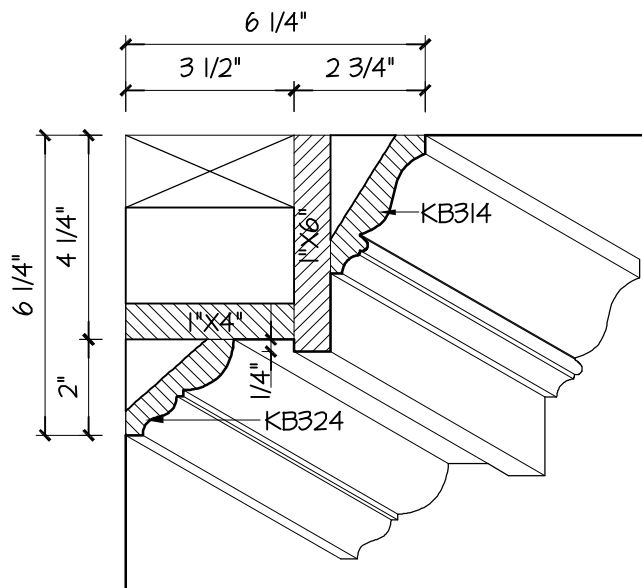

WALL BEAM

SCALE: 3" = 1'-0"



Kuiken Brothers Moulding Coffered Ceiling 7 Detail

CONFIDENTIAL: All material found on this document is the exclusive property of Kuiken Brothers Company, Inc. This may not be duplicated or replicated in any shape or form without the expressed written consent of Kuiken Brothers Company, Inc.

www.kuikenbrothers.com 201.796.2082