



KLEER[®]

DURABLE, REMARKABLE TRIM
CLEARLY BETTER THAN WOOD



KLEER® TRIM PRODUCTS

YOU'LL FIND INSIDE

Kleer VS Wood	8
Trimboards	10
Kleer Konceal®	12
Beadboard	14
Nickel Gap / V-Groove	16
Grove Collection	18
Sheets	20
Post Wraps	22
Mouldings	24
Adhesives & Fasteners	28
Product Specifications	32

*For product warranty details, please visit KleerLumber.com.
The warranty found there is the sole warranty applicable to Kleer products.*

EVERY PIECE OF KLEER TRIM IS ALL THAT

Kleer® gives homeowners the rich, unique presence and authentic detail of real wood in a highly durable, easy-to-maintain package. Contractors love Kleer because it cuts and shapes like wood and is a cinch to install.

Requires Little. Differentiates a Lot.

Give the perfect finish to fascia, soffits, porch ceilings, wainscoting and more. Kleer was meant to create unique designs. And because it's made from durable PVC it adds unique, worry-free personality indoors and out.

Complete Any Home Design Story

The architectural details of a home represent the unique touches that make up its personality. For homeowners, Kleer® offers endless durability and low maintenance. For pros, Kleer works just like wood, because it can be nailed, stapled, glued, bent and even painted.



KLEER BENEFITS **FOR EVERYONE**

Thoroughly Workable

Kleer® Trim goes up quickly and can be used in virtually every trim application, from fascia to wainscoting. Plus it can be heat bent to create a final product that brings any design to fruition.



KLEER VS WOOD

Kleer® PVC trimboards have all the versatility, workability and design potential of wood—whether in the form of corners, fascias, soffits, rakes, casings or any other architectural embellishment. Kleer is engineered for 100% efficient usability for the pro when it comes to installation, and long life for the homeowner.

If you're sensing a "you can have it all" theme here, you're absolutely right. See all the ways Kleer is such a standout choice compared to wood.



**Mold and
Rot Damage**

Insect Damage

Cracking/Splitting

**Requires Painting and
Regular Maintenance**



Split, cup, warp
and rot proof



Moisture Proof,
Insect Resistant



Withstands freeze/thawing
& extreme weather



Ideal for ground or
masonry contact



Paintable



No knots or other
unusable defects

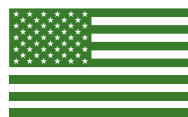

Made in USA

PROTECTING OUR TRIMBOARDS

Keeping Them Clean From Factory to Jobsite

Kleer® PVC trim is engineered to look brilliant for years to come. We also make sure our trimboards stay clean all the way up to installation.

TruEDGE®

Our innovative TruEDGE design provides cleaner, smoother edges that can be easily wiped clean. The result: every piece of trim is installed for a pristine look.

KleerPak®

Our signature KleerPak comes as a prewrapped bundle, which contains further protection with individual MiniPaks™ to keep individual boards clean until they're ready to use. This also allows dealers to sell smaller quantities without leaving the remaining stock exposed to dirt and debris.

Kleer Protective Film

Kleer protective film keeps dust and dirt off trimboards and sheets to keep them clean and crisp until after they're installed. Prominent branding allows for clear identification.

Please check with Customer Service for specific product availability.





KLEER KONCEAL[®]

DETAILS

Save Time On The Jobsite

Kleer Konceal shortens installation time. They're purchased pre-made, so you don't need to lose precious hours fabricating any material on the jobsite.



Klear Trimboard[®] with Nailing Flange Cutouts

Designed with a 1/4" cutout so they install flat over window nailing flanges for a more attractive finished product.

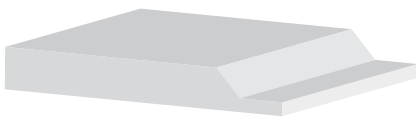

KLEERStart[®]

A 3/4" thick frieze board, the KLEERStart system allows siding to easily fit behind the trimboard, creating a seamless look.

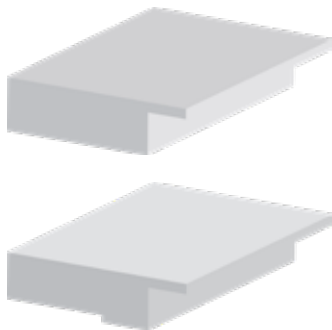

with nailing flange cutout

Klear Konceal[®]

The Konceal System is an innovative system of products from Kleer designed to save builders time and frustration without sacrificing a clean, finished look. These boards and corners have a built-in 3/4" reveal that covers rough cuts at corners as well as around windows and doors where precision cuts can be challenging. Klear Konceal is available in smooth or natural woodgrain textures so you can pair it with vinyl, fiber cement or wood siding.



Kleer Konceal® Corners

A 3/4" reveal makes for easier siding installation and a clean, seamless look.



Kleer Corners®

Traditional trim corners are easy to install and offer the aesthetics of true mitered corners, in both smooth and woodgrain finish.



Outside Corner with Integrated Nailing Flange

Integrated nailing flange forms a 3/4" pocket to conceal end cuts.

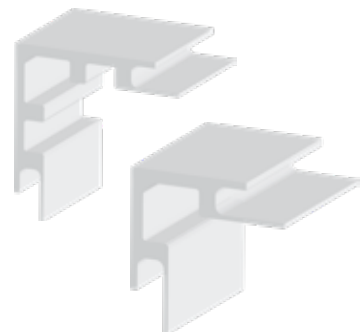

GROVE Collection™

We've enriched our ceiling and soffit standout with a Nickel Gap profile and Trim Board options. So along with V-Groove and Beadboard planks, we've infused stained wood presence into an expanded Grove Collection™ lineup that tops wood in low maintenance and lasting durability.*



6" V-Grooved Plank



6" Beadboard



6" Nickel Gap



Crown



Bed Mould

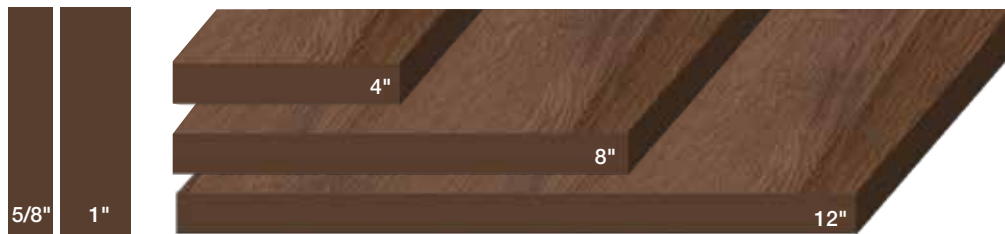

Touch-up paint available.

Cortex Collated Plugs Hidden Fastening System



Fastest, easiest way to conceal fastener heads when installing Grove products!

- TORX® ttap® Drive System eliminates fastener strip-out
- 2" fastener ideal for 5/8" to 5/4" PVC Trimboard
- Packaged 75 screws, 80 plugs, 1 setting tool, covers 50 LF





V-Groove in Natural Cedar

AMERICAN WALNUT

CHARRED TIMBER

NATURAL CEDAR

OAK RIDGE

SMOKE GREY

WEATHERED OAK

*Not for side wall applications Actual colors may vary slightly from printed brochure.

KLEER BEADED BOARDS

Timelessly Detailed. Beautifully Textured.

Whether you're looking to raise the profile of porch ceilings, soffits, bathrooms, laundry rooms or any other area that can use a refresh, our beaded boards expand expression with a wealth of profiles and applications.

KleerLok® Beaded Boards

This edge-and-center bead profile features a shiplap nailing flange that increases installation speed and improves the finished look.

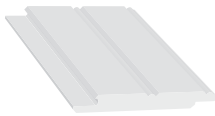

4" KleerLok



6" KleerLok



8" KleerLok

On-Center Bead reverses to V-Groove Tongue and Groove



KleerLok T-Moulding

Used for connecting end joints of 1/2" Kleer Beaded products

Edge and Center Beadboard

This traditional profile replicates the look of tongue and groove wood planks that's ideal for soffits and other applications.



Reverses to V-Groove

KLEERBeed® Beaded Sheets

KLEERBeed Beaded Sheets offer a finished look similar to individual boards, while their larger size makes for fast installation and a consistent surface.

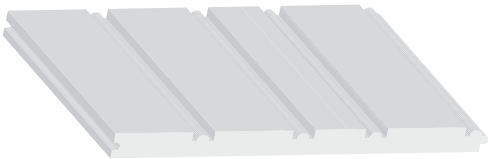

2" On-Center Bead Tongue and Groove

*Please check local building codes prior to using Kleer for indoor applications. Always follow local building codes and construction best practices.



NICKEL GAP / V-GROOVE PLANK

6" Reversible

Kleer® Reversible Nickel Gap/V-Groove profile adds charming and timeless detail to any home style, minus the maintenance. Suitable for both modern and traditional designs, both Nickel Gap and V-Groove panels stand out as an accent wall or work as an elegant, durable surface for high-traffic or moisture-prone interior areas.

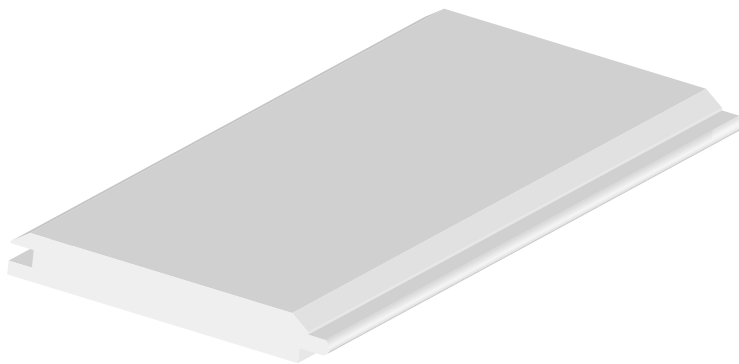

- Clean, crisp lines deliver refined aesthetics
- Durable, low-maintenance PVC Technology
- Can be installed vertically or horizontally
- Tongue & Groove joint simplifies the installation
- Exterior application: soffit and porch ceilings*
- Waterproof and termite proof
- Paintable

*Not for exterior sidewall application



CLEARLY VERSATILE KLEER SHEETS & TRIMBOARD

Ideal for a variety of millwork applications and custom details, Klear Sheets are available in a wide range of thicknesses and sizes. Choose smooth or use the optional woodgrain finish on one side.

Klear Sheets and Trimboard offer design flexibility for every kind of application—all the distinctive beauty of wood without the upkeep or rot. And just like wood, you can nail, staple, glue, bend and paint it to create any piece of architectural millwork. Infused with UV inhibitors that provide long-lasting protection, Klear Trimboard is perfect for creating authentic accents with a look that will last for years and years.

Klear Sheets®

Available from 1/4" to 1" nominal, Klear Sheets offer the versatility for a variety of millwork applications, as well as for framing out multiple windows and other custom uses.

Klear Custom Sheets

Klear 1-1/4" Sheets are perfect for corbels, mouldings, and any custom PVC millwork.



Woodgrain



Smooth



KLEERWRAP POST WRAPS

Amp Up Presence With Ease.

KLEERWrap® Post Wraps* add instant distinction to existing columns. And since they feature the same advanced PVC technology as our other Klear products, they're virtually impervious to moisture and insects. Even better news: they can be quickly installed by just one person using Klear PVC adhesives.

Each kit comes with two bed moulding sets. Additional bed, crown, base cap moulding and outer wrap sets are sold separately.



*Non-load bearing.

All KLEERWrap mouldings are mitered and cut to length to fit all KLEERWrap Post Wrap sizes.

1. Post Wrap

2. Bed Moulding Set

KLEERWrap Post Wrap comes with two Bed Moulding sets.

3. Base Cap Moulding Set

Available separately.

4. Outer Wrap Set

Available separately.

5. Crown Moulding Set

Available separately.

Kleer Post Wraps are easy to install on both new construction and remodeling projects.



KLEER MOULDINGS

Fully Finished From Top to Bottom.

Kleer® Mouldings bring wood aesthetics and PVC protection to everything from crowns, corners and casings to wainscoting, chair rails, water tables and weather stops. Beautifully realistic patterns and textures tie together home designs inside and out. Long-lasting performance keeps it that way.

Casing

Surface application around doors, walls and windows.



Brick Mould



J-Channel Brick Mould



Brick Mould with Nail Fin

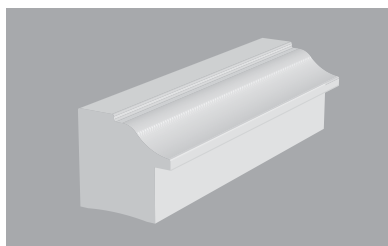

Back Band

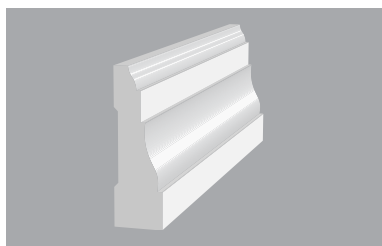

Casing

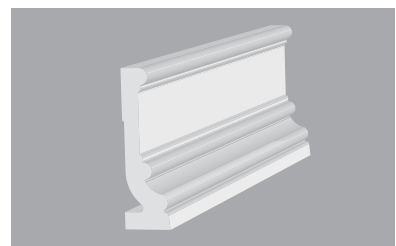

RB3 Casing



Adams Casing



5/4 x 6 J-Channel Casing



5/4 x 4 J-Channel Casing

Product Specifications can be found starting on page 26.



Window Detail

Sill and drip cap for window applications.

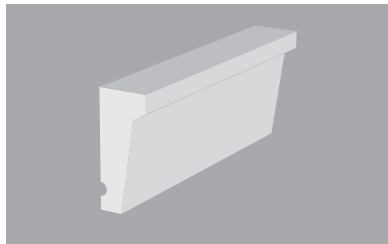

Drip Cap

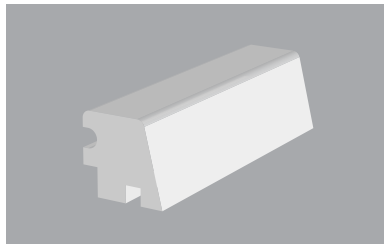

Sill Nose

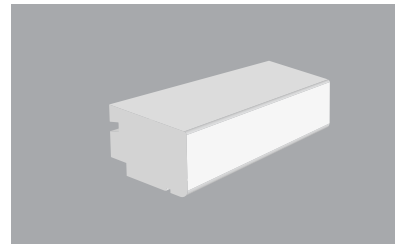

Large Historic Sill Nose

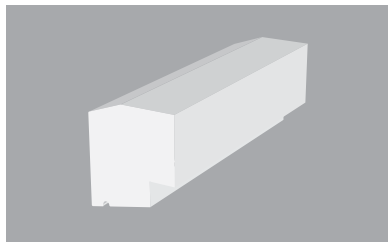

Historic Sill Nose

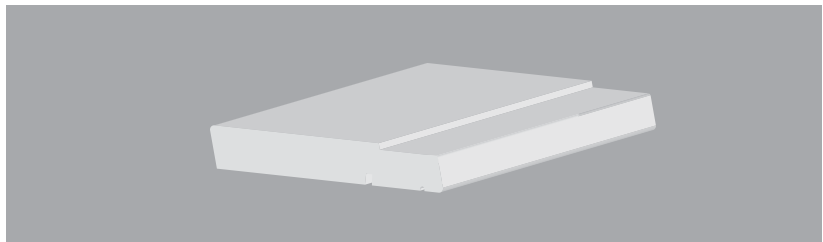

Replacement Sill

*Please check local building codes prior to using Klear for indoor applications. Always follow local building codes and construction best practices.

Detail

Additional trim used to accent primary trim.

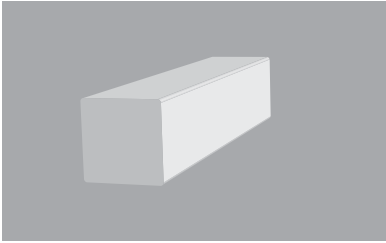

Baluster



Base Cap

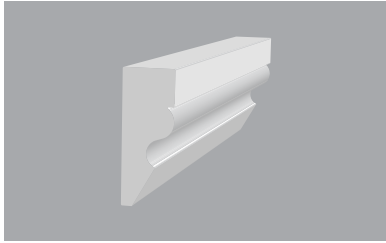

Band Moulding

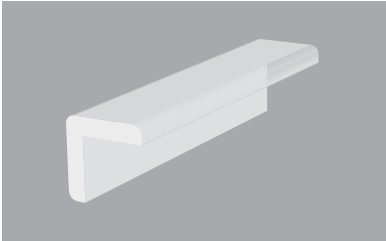

Outside Corner

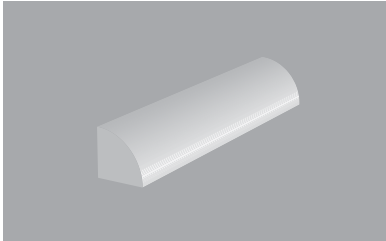

Quarter Round

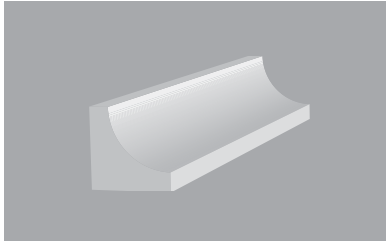

Cove/Scotia

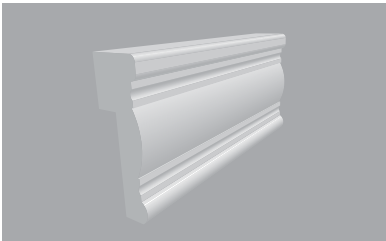

Wainscot Cap/Base

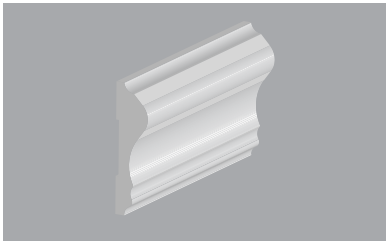

Chair Rail



Water Table

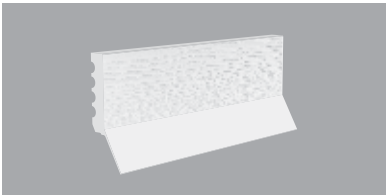

Weather Stop

Roofing Detail

Trim for rake and fascia.

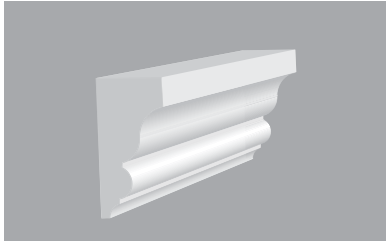

Imperial Rake Moulding



Rake Moulding

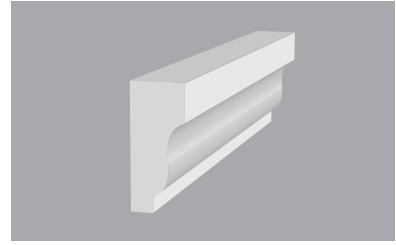

Shingle Band

Crown Mouldings

Used at the intersection of walls and ceilings.

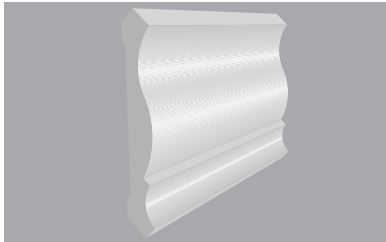

7-1/2" Crown Moulding

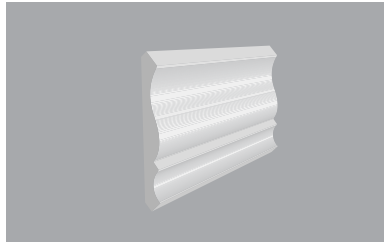

5-1/4" Crown Moulding

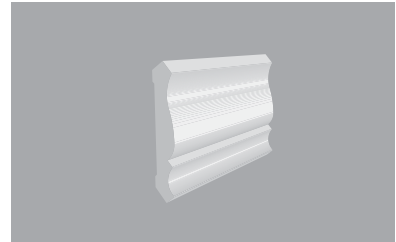

4-5/8" Crown Moulding

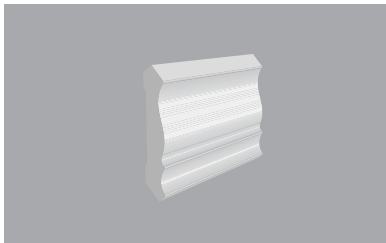

3-5/8" Crown Moulding

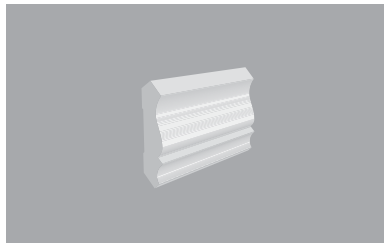

2-3/4" Crown Moulding

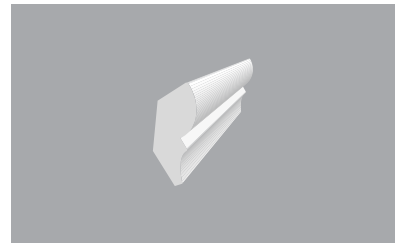

Bed Moulding

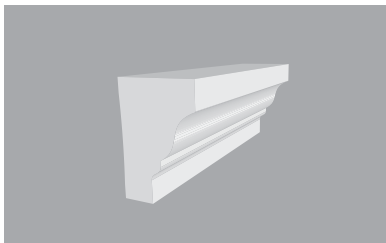

Rams Crown



Deco Crown

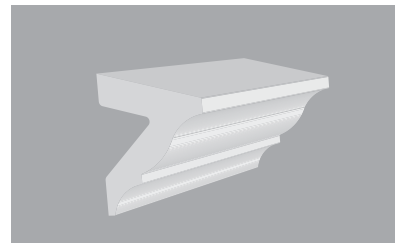

One Piece Crown

THE DIFFERENCE BETWEEN DONE AND FINISHED

Adhesives & Fasteners

Our adhesives and fasteners give every Kleer® a seamless look. Use our variety of adhesives and sealants to fill gaps and nail holes and create tight, weatherproof bonds. They're precisely formulated for use with Kleer Cellular PVC Trim products. Use our Cortex® for Kleer fastener system to make unsightly fastener heads disappear.



① **Kleer Cellular PVC Adhesive**

Two-part structural adhesive. 100% waterproof, UV stable, can be sanded and painted, and is color matched to Kleer PVC trim products. It can be used to fill nail holes and gaps up to 1/8" without the need for fasteners or biscuits.

20–25 minute work time.

Ideal for applications where a slower work time is preferred. 25ml, 50ml, and 220ml cartridges

4–7 minute work time.

50ml and 220ml cartridges

② **Kleer Structural Sealant**

A multi-purpose product. Its tenacious adhesion and elastomeric properties make it the ideal product for filling expansion gaps and filling nail holes.

It skins over quickly and can be painted in 2 hours, with a full cure time of roughly one week.

③ **Kleer Cellular PVC Nail Stick**

A two-part epoxy putty used for filling nail holes in PVC. Cures off-white to light grey. Sand it, drill it and paint it to make a great finish for any installation.

④ **Kleer Cellular PVC Laminating Adhesive**

A two-part structural adhesive. Lower viscosity for enhanced "flow-out."

Requires less clamping pressure for a thin, void-free bond when laminating cellular PVC faces together to create thicker pieces.

220ml cartridges



Klear Applicator Gun Adapter and Klear Quick Mixer Tip



Klear Caulk Gun Adapter and Klear Quick Mixer Tip

Klear Quick Mixer Tips

For use with Klear Cellular PVC Adhesive. Get the perfect, on-ratio mix each and every time. Designed with a low internal volume for less waste and greater value.

1:1 ratio cartridges for simple and effective application. 24 count.

For 50ml and 220ml cartridges

Klear Applicator Guns

Used to easily extrude the correct mix of Klear

Cellular PVC Adhesives.

For 50ml and 220ml cartridges



Cortex® Hidden Fastening System

- 1** 750 Lin. Ft.
 1,125 screws, 1,200 plugs and setting tool. 2" length available in smooth finish. 2-3/4" length available in smooth or woodgrain finish.
- 2** 250 Lin. Ft.
 375 screws, 400 collated plugs and setting tool. 2" and 2-3/4" lengths available in smooth or woodgrain finish.
- 3** 50 Lin. Ft.
 75 screws, 100 plugs and setting tool. Smooth or woodgrain finish.

PRODUCT SPECIFICATIONS

Kleer Trimboard® with Nailing Flange Cutouts

Available in smooth and woodgrain finish.

Thickness	Length	Available Widths (Actual)	
		4 (3-1/2")	6 (5-1/2")
15/16"	18'	•	•

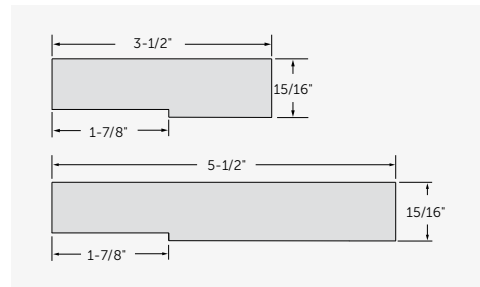

KLEERStart®

Available in smooth and woodgrain finish.

Thickness	Length	Available Widths (Actual)	
		6 (5-1/2")	8 (7-1/2")
3/4"	18'	•	•

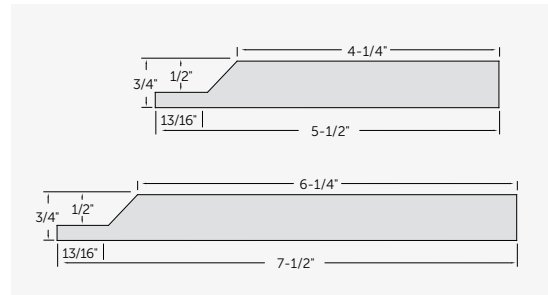

Kleer Konceal®

Available in smooth and woodgrain finish.

Description	Nominal Size	Actual Size	Available Widths (Actual)			
			10'	16'	18'	20'
Kleer Konceal Trimboard	5/4 x 4	15/16" x 3-1/2"			•	
Kleer Konceal Trimboard	5/4 x 6	15/16" x 5-1/2"			•	
Kleer Konceal Trimboard with Nailing Flange Cutout	5/4 x 4	15/16" x 3-1/2"			•	
Kleer Konceal Trimboard with Nailing Flange Cutout	5/4 x 6	15/16" x 5-1/2"			•	
Kleer Konceal Corners	5/4 x 4	15/16" x 3-1/2"	•			•
Kleer Konceal Corners	5/4 x 6	15/16" x 5-1/2"	•			•

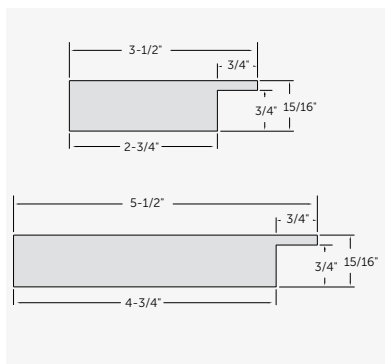

Kleer Konceal® Trimboard

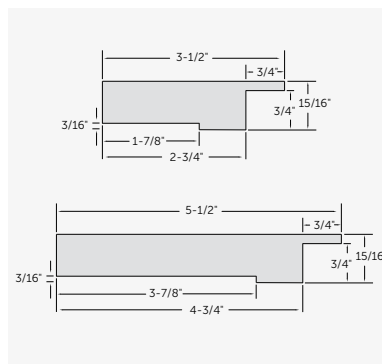

Kleer Konceal® Trimboard with Nailing Flange Cutout

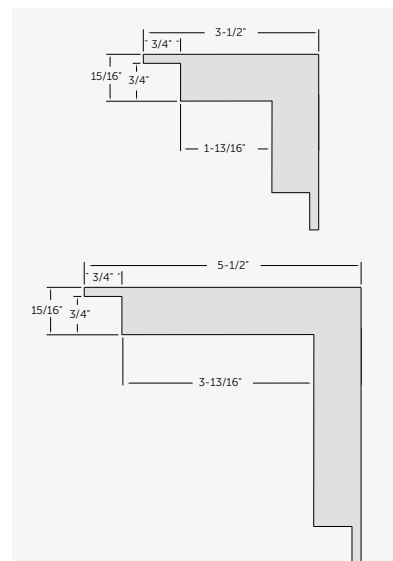

Kleer Konceal® Corner

Kleer Corners®

Available in smooth and woodgrain finish.

Description	Nominal Size	Actual Size	Available Lengths	
			10'	12'
Kleer Corners	5/4 x 4	15/16" x 3-1/2"	•	•
Kleer Corners	5/4 x 6	15/16" x 5-1/2"	•	•

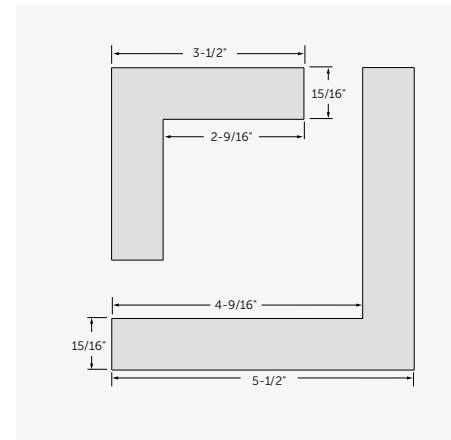

Outside Corner with Integrated Nailing Flange

Smooth finish.

Description	Actual Size	Length
		20'
4 x 4	3-1/2" x 3-1/2"	•
6 x 6	5-1/2" x 5-1/2"	•

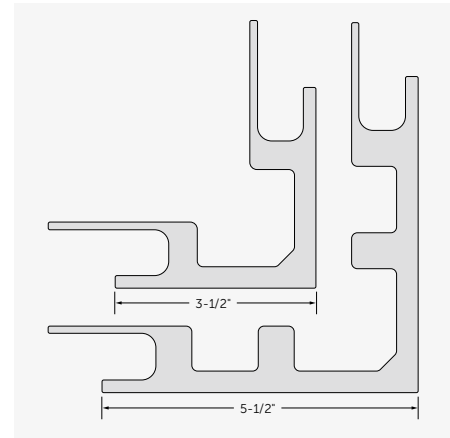

Beaded Boards

Smooth finish.

Description	Size (Actual)	Length				On-Center Bead	Reverses to V-Groove
		8'	10'	16'	18'		
4" KLEERLok Beaded Board	1/2" x 3-1/4"			•		1-5/8"	•
6" KLEERLok Beaded Board	1/2" x 5"			•		2-1/2"	•
8" KLEERLok Beaded Board	1/2" x 7-1/4"			•		1-5/8"	•
KLEERLok T-Moulding	5/8" x 2-1/2"			•			
Edge and Center Bead Board	3/4" x 6"				•	2-1/2"	•
KLEERBeed Beaded Sheet	1/2" x 48"	•	•			2"	

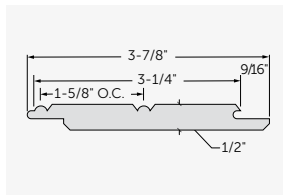

4" KLEERLok® Beaded Board

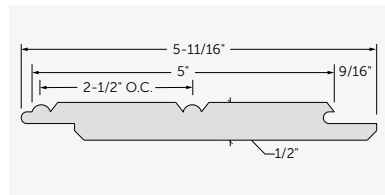

6" KLEERLok® Beaded Board

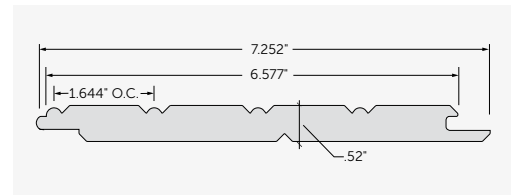

8" KLEERLok® Beaded Board

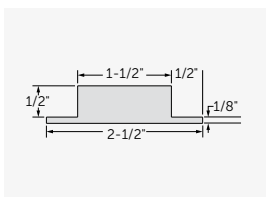

KLEERLok® Moulding

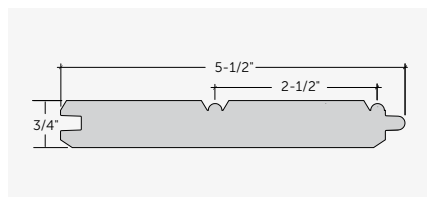

Edge and Center Bead Board

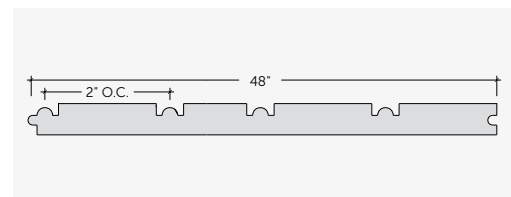

KLEERBeed® Beaded Sheets

Product offering subject to change. Please check with Customer Service for product availability.

6" Reversible Nickel Gap/V-Grooved Plank

Description	Size (Actual)	Length
6" Nickel Gap/V-Grooved Plank	3/4" x 5-1/2"	18'

Grove Collection™

Description	Size (Actual)	Length
6" V-Grooved Plank *	3/4" x 5-1/2"	18'
6" Beadboard *	1/2" x 5-1/2"	18'
6" Nickle Gap *	3/4" x 5-7/8"	18'
Crown	9/16" x 3-5/8"	16'
Bed Mould	9/16" x 1-9/16"	16'
Trimboard 5/8 x 4	5/8" x 3-1/2"	18'
Trimboard 1 x 8	3/4" x 7-1/4"	18'
Trimboard 1 x 12	3/4" x 11-1/4"	18'

*Not for side wall applications.

Kleer Trimboard®

Available in smooth and woodgrain finish.

Nominal Thickness	Actual Thickness	Available Lengths		Available Widths (Actual)								TruEdge®	
		18'	20'	3 (2-1/2")	4 (3-1/2")	5 (4-1/2")	6 (5-1/2")	8 (7-1/4")	10 (9-1/4")	12 (11-1/4")	16 (15-1/4")		
5/8"	5/8"	•		•	•	•	•	•	•	•	•	•	•
1"	3/4"	•		•	•	•	•	•	•	•	•	•	•
5/4	15/16"	•	•	•	•	•	•	•	•	•	•	•	•
6/4	1-1/4"	•		•	•	•	•	•	•	•	•	•	

Kleer Sheets®

Reversible smooth/woodgrain finish.

Actual Thickness	Width	Available Lengths					
	4'	8'	10'	12'	18'	20'	
1/4"	•	•	•	•	•		
3/8"	•	•	•	•	•		
1/2"	•	•	•	•	•		
5/8"	•	•	•	•	•		
3/4"	•	•	•	•	•	•	
15/16"	•	•	•	•	•	•	

Custom widths and lengths available. Please check with your local dealer for product availability in your market.

Kleer Custom Sheets

Reversible smooth/woodgrain finish.

Actual Thickness	Width	Available Lengths					
	4*	8'	10'	12'	16'	18'	20'
1-1/4"	•	•	•	•	•	•	•

*Nominal 48", Actual 47" ± 3/4"

Custom widths and lengths available. Please check with your local dealer for product availability in your market.

KLEERWrap® Post Wraps

Smooth finish.

Description	Available Lengths		Inside Dimension (Actual)	Outside Dimension (Actual)	Post Size (Nominal)
	8'	10'			
4" Post Wrap	•	•	3-3/4" x 3-3/4"	4-1/2" x 4-1/2"	4" x 4"
6" Post Wrap	•	•	5-3/4" x 5-3/4"	6-1/2" x 6-1/2"	6" x 6"
8" Post Wrap		•	6-1/4" x 6-1/4"	7" x 7"	6" x 6"
10" Post Wrap		•	8" x 8"	9" x 9"	8" x 8"

KLEERWrap® Outer Wrap

Smooth finish.

Description	Available Lengths			Inside Dimension (Actual)	Outside Dimension (Actual)	Thickness (Actual)
	5"	7"	12"			
4" Outer Wrap	•	•	•	4-1/2" x 4-1/2"	5-1/2" x 5-1/2"	1/2"
6" Outer Wrap	•	•	•	6-1/2" x 6-1/2"	7-1/2" x 7-1/2"	1/2"
8" Outer Wrap	•	•	•	7" x 7"	8" x 8"	1/2"
10" Outer Wrap	•	•	•	9" x 9"	10" x 10"	1/2"

KLEERWrap® Mouldings

Smooth finish. All KLEERWrap mouldings are mitered and cut to length to fit all KLEERWrap Post Wrap sizes.

Description	Available for Post Wrap Sizes				Available for Outer Wrap Sizes			
	4"	6"	8"	10"	4"	6"	8"	10"
Bed Moulding Set*	•	•	•	•	•	•	•	•
Base Cap Moulding Set	•	•	•	•				
Crown Moulding Set	•	•	•	•				

*Each KLEERWrap Post Wrap comes with two Bed Moulding Sets. Additional moulding sets purchased separately.

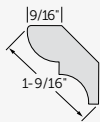

Bed Moulding

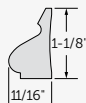

Base Cap Moulding

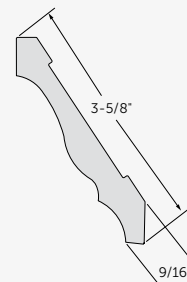

Crown Moulding

Mouldings: Casing

Smooth finish.

Description	Part Number	Size (Actual)	Length	Pieces/Bundle
Brick Mould	#5180R18	1-1/4" x 2"	18'	6
Brick Mould	#5180R17	1-1/4" x 2"	17'	6
Brick Mould	#5180R10	1-1/4" x 2"	10'	6
Brick Mould	#5180R07	1-1/4" x 2"	7'	6
J-Channel Brick Mould	#5657R17	1-1/4" x 3"	17'	4
Brick Mould with Nail Fin	#7371R18	1-1/4" x 3"	18'	4
J-Channel Casing	#7651R18	1-1/8" x 5-1/2"	18'	2
J-Channel Casing	#7968R16	1-1/8" x 3-1/2"	16'	2
J-Channel Casing	#7968R18	1-1/8" x 3-1/2"	18'	2
Casing	#2351R16	11/16" x 2-1/4"	16'	12
RB3 Casing	#2369R8	1" x 3-1/2"	8'	4
Adams Casing	#2852R16	1" x 3-1/2"	16'	2
Back Band	#7931R16	1-3/8" x 1-7/16"	16'	10

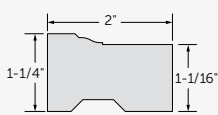

Brick Mould
#5180R18, #5180R17, #5180R10,
#5180R07

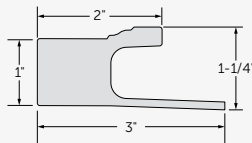

J-Channel Brick Mould
#5657R17

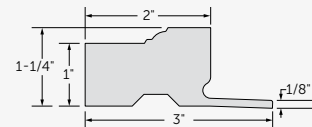

Brick Mould With Nail Fin
#7371R18

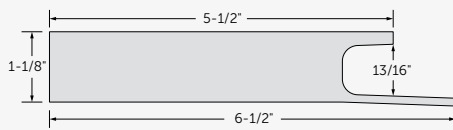

J-Channel Casing
#7651R18

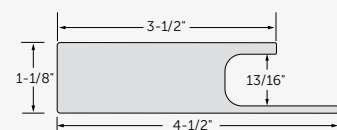

J-Channel Casing
#7968R16, #7968R18

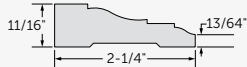

Casing
#2351R16

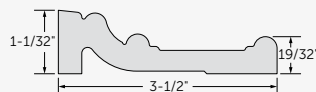

RB3 Casing
#2369R8

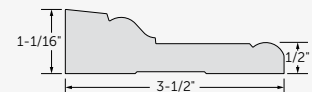

Adams Casing
#2852R16

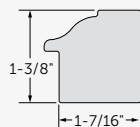

Back Band
#7931C16

Mouldings: Window Detail

Smooth finish.

Description	Part Number	Size (Actual)	Length	Pieces/Bundle
Drip Cap	#5283R16	11/16" x 1-5/8"	16'	12
Sill Nose	#5311R16	1-3/8" x 1-5/16"	16'	8
Large Historic Sill Nose	#7435R16	1-3/4" x 2-3/8"	16'	2
Historic Sill Nose	#7650R16	1-3/4" x 2"	16'	2
Replacement Sill	#960810Sill	1-1/4" x 7-1/4"	10'	2

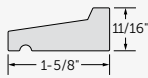

Drip Cap
#5283R16

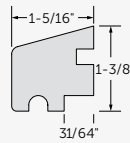

Sill Nose
#5311R16

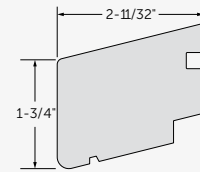

Large Historic Sill Nose
#7435C16

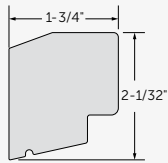

Historic Sill Nose
#7650R16

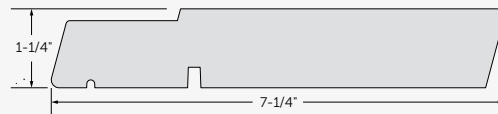

Replacement Sill
#960810Sill

Mouldings: Roofing Detail

Smooth finish.

Description	Part Number	Size (Actual)	Length	Pieces/Bundle
Imperial Rake Moulding	#7962R16	1-3/8" x 2-3/4"	16'	4
Rake Moulding	#5287R16	1-1/16" x 2"	16'	10
Shingle Band	#5210R16	11/16" x 1-5/8"	16'	10

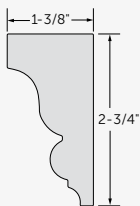

Imperial Rake Moulding
#7962R16

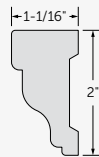

Rake Moulding
#5287R16

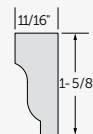

Shingle Band
#5210R16

Mouldings: Detail

Smooth finish.

Description	Part Number	Size (Actual)	Length	Pieces/Bundle
Baluster	#5150R12	1-1/2" x 1-1/2"	12'	6
Base Cap	#5164R16	11/16" x 1-1/8"	16'	20
Band Moulding	#5168R16	5/8" x 1-3/4"	16'	10
Outside Corner	#7719R16	1-1/8" x 1-1/8"	16'	12
Quarter Round	#5234R16	3/4" x 3/4"	16'	20
Cove/Scotia	#5245R16	3/4" x 3/4"	16'	40
Wainscot Cap/Base	#2566R8	1" x 3"	8'	4
Weather Stop*	#7951R16	7/16" x 2"	16'	15
Chair Rail	#5390R8	11/16" x 2-5/8"	8'	6
Water Table	#5170R18	1-5/8" x 2-9/16"	18'	4

*Embossed finish.

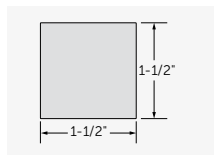

Baluster
#5150R12

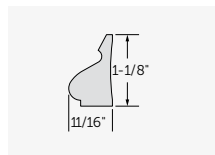

Base Cap
#5164R16

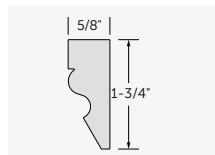

Band Moulding
#5168R16

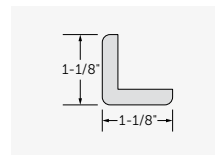

Outside Corner
#7719R16

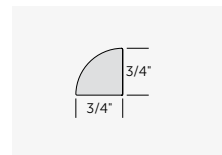

Quarter Round
#5234R16, #5324R8

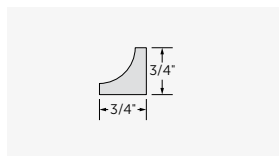

Cove/Scotia
#5245R16

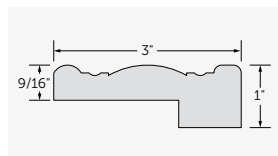

Wainscot Cap/Base
#2566R8

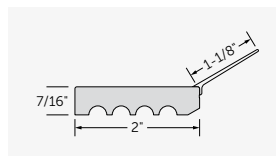

Weather Stop
#7951R16

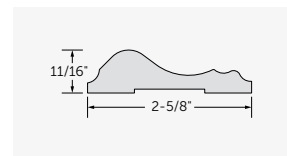

Chair Rail
#5390R8

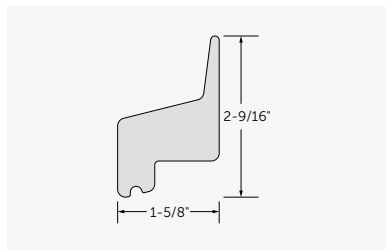

Water Table
#5170R18

Mouldings: Crown Mouldings

Smooth finish.

Description	Part Number	Size (Actual)	Length	Pieces/Bundle
7-1/2" Crown Moulding	#5041R16	1" x 7-1/2"	16'	2
5-1/4" Crown Moulding	#5045R16	9/16" x 5-1/4"	16'	4
4-5/8" Crown Moulding	#5047R16	11/16" x 4-5/8"	16'	4
3-5/8" Crown Moulding	#5049R16	9/16" x 3-5/8"	16'	10
2-3/4" Crown Moulding	#5063R16	9/16" x 2-3/4"	16'	10
Bed Moulding	#5075R16	9/16" x 1-9/16"	16'	10
Rams Crown	#5158R16	1-3/8" x 2-1/16"	16'	6
Deco Crown	#7712R16	1-1/2" x 1-7/8"	16'	6
One Piece Crown	#7960R12	2-3/4" x 3-1/2"	12'	2

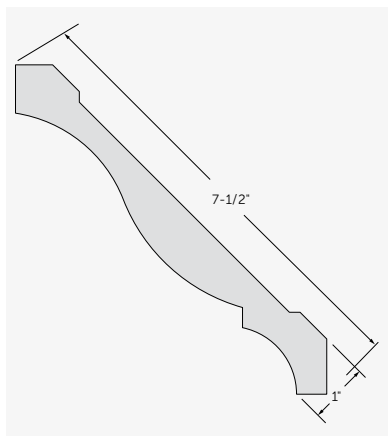

7-1/2" Crown Moulding
#5041R16

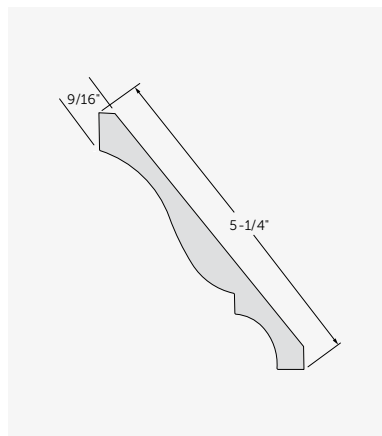

5-1/4" Crown Moulding
#5045R16

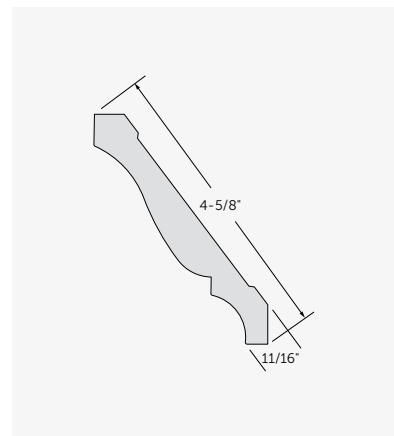

4-5/8" Crown Moulding
#5047R16

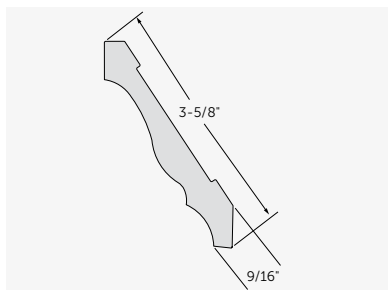

3-5/8" Crown Moulding
#5049R16

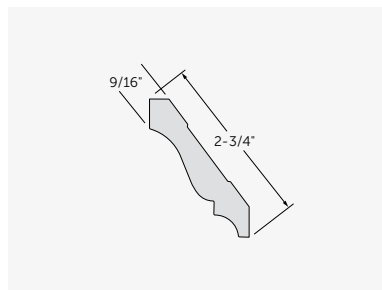

2-3/4" Crown Moulding
#5063R16

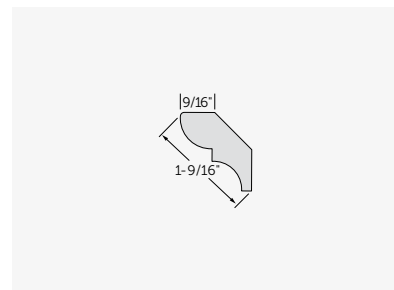

Bed Moulding
#5075R16

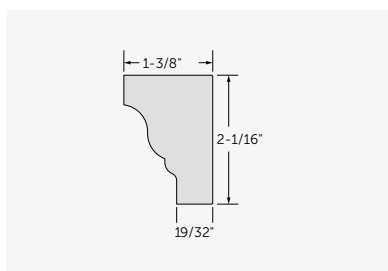

Rams Crown
#5158R16

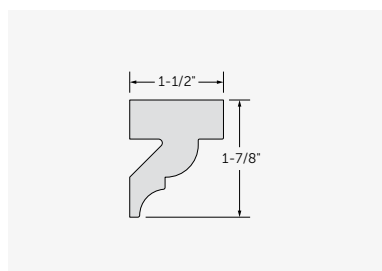

Deco Crown
#7712R16

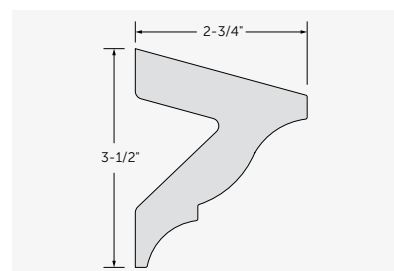

One Piece Crown
#7960R12



Westlake

© 2025 Westlake

Kleer Lumber®
KleerLumber.com | 800-521-8486
Item# KL036 | KLR335400 2/25

