

RESIDENTIAL & COMMERCIAL BUILDING MATERIALS



KUIKEN BROTHERS
COMPANY INCORPORATED

Since 1912

M O U L D I N G



M I L L W O R K

❖ Catalog ❖

FALL 2023

\$6.95

WWW.KUIKENBROTHERS.COM



For over 110 years, Kuiken Brothers, a family owned and operated business, has been supplying top quality residential and commercial building materials to contractors and homeowners. We have dedicated ourselves to providing the very best in quality, service and product selection. We are pleased to present you with this Moulding & Millwork catalog and hope that you find it to be a valuable resource in planning your projects.

On behalf of the Kuiken family and our knowledgeable and experienced employees, we remain committed to providing you with the finest products and services available, at all of our convenient locations.

Sincerely,

Douglas R. Kuiken

PRESIDENT, KUIKEN BROTHERS COMPANY, INC





KUIKEN BROTHERS COMPANY, INC.

RESIDENTIAL & COMMERCIAL BUILDING MATERIALS

Since 1912

MISSION STATEMENT

To be the leading provider of Residential and Commercial Building Materials in the markets we serve.

To exceed our customers' needs and expectations by consistently providing quality materials and solutions in a responsive, respectful manner within a framework and culture of honesty, integrity and professionalism.

MOTTO
GET IT RIGHT!

Honesty

Integrity

Professionalism

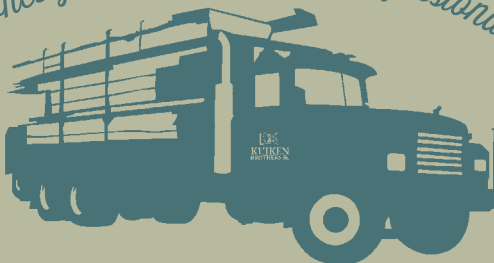



KUIKEN BROTHERS COMPANY, INC

inventories one of the largest collections of premium stock moulding profiles in the region. We are certain you will find a package of profiles that will quickly add charm and turn a house into a home or a commercial space steeped in sophistication. Keep your projects moving forward. Choose Kuiken Brothers stock moulding profiles.





COMMERCIAL BUILDING MATERIALS



DRYWALL ■ METAL STUDS ■ CEILING SYSTEMS ■ INSULATION ■ COMMERCIAL DOORS & HARDWARE

LOCATIONS WITH LARGEST COMMERCIAL BUILDING MATERIAL INVENTORY



SUCCASUNNA, NJ: 33 ROUTE 10 EAST, SUCCASUNNA, NJ 07876
(973)968-7700

EMERSON, NJ: 246 KINDERKAMACK RD EMERSON, NJ 07630
(201)262-6666

GARFIELD, NJ: 485 RIVER DR., GARFIELD, NJ 07026
(973)772-0044

NEWARK, NJ: 500 DOREMUS AVE., NEWARK, NJ 07105
(973)638-7200

visit

www.KuikenBrothers.com

Kuiken Brothers is a jobsite friendly site that can be viewed just as easily on your mobile device as your desktop. When was the last time you actually flipped through that printed product installation guide (be honest!)? Video mobile friendly websites are revolutionizing the way our industry learns about new products and proper installation methods. The New KuikenBrothers.com promises to deliver video and large photos, perfect for huddling around an iPad or iPhone on a jobsite.





**DOWNLOAD THE CLASSICAL
MOULDING CATALOG**



CLASSICAL MOULDING INSPIRED BY 18TH CENTURY PATTERNS

READY FOR YOUR NEW OLD HOUSE, WITHOUT THE LEAD TIME

Kuiken Brothers Classical Moulding is a collection of primed poplar moulding profiles (16' lengths, in-stock). The designs are inspired by Georgian, Federal, Greek Revival, Colonial Revival and Traditional Revival homes built over 200 years ago.



Casings.....pgs 16 – 29

Base..... pgs 44 – 47, 54 – 56

Crownpgs 64 – 70

Chair Rail.....pgs 94 – 97

Panelpgs 99 – 102



Grown, Harvested & Milled In the U.S.A.



PICK UP A CLASSICAL
MOULDING CATALOG
IN-STORE OR REQUEST ONE
ON KUIKENBROTHERS.COM

WWW.KUIKENBROTHERS.COM/CLASSICAL

5/4" Cap

KB376

1"x4"

KB381

1"x6"

1"x4"

KB384

1"x6"

KB883



DOWNLOAD THE MODERN
CRAFTSMAN CATALOG

KB267



KUIKEN BROTHERS

MODERN CRAFTSMAN

MOULDING COLLECTION

The Modern Craftsman Moulding Collection blends the simplicity of profiles found in Craftsman style homes built in the early 20th Century while still maintaining proper scale and proportion, inspired by our Classical Moulding Collection. These profiles are not scant. They are all milled from poplar which creates deep incisions and crisp edges, ensuring each shadow line is purposeful and meaningful. It works great today as a simple, yet bold application for those looking to achieve a modern look with a classical edge.



Grown, Harvested & Milled In the U.S.A.



PICK UP A MODERN
CRAFTSMAN CATALOG
IN-STORE OR REQUEST ONE
ON KUIKENBROTHERS.COM

WWW.KUIKENBROTHERS.COM/MODERN_CRAFTSMAN

DOWNLOAD CAD FILES AT WWW.KUIKENBROTHERS.COM

ARCHITECTS AND INTERIOR DESIGNERS

Add detail to your plans by downloading specific moulding profiles to your blueprints. Download the CAD file that accompanies each profile. Pictured below is the online version of Kuiken Brothers stock moulding catalog.

KUIKEN BROTHERS COMPANY INC.
RESIDENTIAL & COMMERCIAL BUILDING MATERIALS *Since 1919*

ABOUT PRODUCTS BLOG EVENTS FIND A STORE CONTACT

8 LOCATIONS IN NEW JERSEY & NEW YORK INFO@KUIKENBROTHERS.COM 201.662.1000

SUBSCRIBE TO OUR E-NEWSLETTER MEMBERS ONLY

HOME / PRODUCTS / RESIDENTIAL / MOULDING / CASING

CASING

FIND MOLDINGS BY:

TYPE (CASING, BASE, CORNER, ETC.) MATERIAL (PINE, OAK, PVC, ETC.) COLLECTION (CLASSICAL, MODERN, ETC.) PROFILE NUMBER

ARE YOU LOOKING FOR CASING IN A SPECIFIC MATERIAL?

All Materials

KB123 Georgian Casing
2" x 5 1/2"
See Details

KB106 Casing
1 1/2" x 5 1/2"
See Details

KB112 Casing
1 1/2" x 5 1/2"
See Details

KB119 Casing
1 1/2" x 5 1/2"
See Details

KB109 Casing
1 1/2" x 5 1/2"
See Details

KB117 Casing
1 1/2" x 5 1/2"
See Details

KB114 Casing
1 1/4" x 5 1/2"
See Details

KUIKEN BROTHERS COMPANY INC.
RESIDENTIAL & COMMERCIAL BUILDING MATERIALS *Since 1919*

8 LOCATIONS IN NEW JERSEY & NEW YORK INFO@KUIKENBROTHERS.COM 201.662.1000

SUBSCRIBE TO OUR E-NEWSLETTER MEMBERS ONLY

KB106 CASING

TYPE (CASING, BASE, CORNER, ETC.) MATERIAL (PINE, OAK, PVC, ETC.) COLLECTION (CLASSICAL, MODERN, ETC.) PROFILE NUMBER

AVAILABLE IN:
 Wood
 Plastic
 Metal (only with steel)

TYPE:
Casing

COLLECTION:
 All Classical Moulding
 Colonial
 Colonial Modern
 Classical - Pattern
 Colonial - Traditional Pattern

GET A QUOTE FOR THIS PROFILE

DOWNLOAD PROFILE

Learn more about Kuiken Brothers' Classical Moulding

10106 Casing
1 1/2" x 5 1/2"

INDEX

Volume 18, 2023

ORDERING KUIKEN BROTHERS MOULDINGS: 260

Casings: 16-43

Bases: 44-62

Crowns: 64-81

Combination Ideas: 63, 82-86, 104, 174-200

MDF Mouldings: 134-143

MOULDINGS

Astragal & Mullion Center	115-116	Cove Mouldings	65, 71, 74, 75, 89-91, 151
Back Band	20, 41	Crown Mouldings	64-85, 87, 139-142, 144, 148-150
Baluster	111	Dentil Mouldings	69, 87
Base Cap Moulding	54-57	Door & Window Casing	16-43
Base Mouldings	44-63	Drip Cap	120, 152
Beadboard	160-162	Extension Jamb	122-123
Bed Mouldings	68-70, 77	Exterior Surrounds	158
Brick Moulding	120, 152	Exterior Trim	148-158
Bull Nose	108	Floor Mouldings	61
Casings	16-43	Glass Bead	119
Chair Rail Mouldings	94-98	Half Round Mouldings	114
Clam Stop	110	Hand Rails	106-107
Classical Moulding	16-29, 41-48, 54-56, 64-70, 87, 90, 93-102, 115, 174-200	Hardwood Boards	243
Colonial Stop	108-109	Historic Moulding	16-29, 41-48, 54-56, 64-70, 87, 90, 93-102, 115, 174-200
Corner Guard	117-118	KB Ultra MDF Primed	134-142
		Kleer TruEDGE	156

**VISIT OUR SHOWROOMS TO VIEW MOULDING,
WINDOW AND DOOR COMBINATIONS**





INDEX *continued*

KleerWrap 157
 Landing Tread..... 129
 Lattice Mouldings..... 112
 Mantel Combinations... 174-177, 190-195
 MDF Moulding..... 134-145
 Modern Craftsman... 30-33, 48-53, 71-74, 97
 Moulding Design Guide..... 174-200
 Mullion Center..... 115-116
 Neck Moulding 81
 Nose & Cove Mouldings 88
 Nosing 129
 Outside Corner..... 117-118
 Panel Mouldings..... 99-103
 Parting Strip 111
 Pattern Boards..... 160-161
 Picture Frame/Rail Moulding 119
 Pilaster Mouldings 92-93
 Plinth Blocks..... 131-132
 Pole Mouldings..... 113
 Prestige Line 144-146
 PVC Mouldings 148-155
 Quarter Round Mouldings..... 105
 Quirk 101
 Reeded Accent 92-93
 Rosettes..... 132
 Saddles 130
 Sanitary Corner Guard..... 117
 Shelf Edge..... 121
 Shingle Band..... 150
 Shiplap 160
 Shoe Moulding..... 53, 61, 110
 Siding 164-167
 Sill..... 130, 154-155
 Sill Nosing 154
 Skewback 121
 Skirl Siding..... 165
 Solid Crown 80-81, 150
 Stool..... 124-128
 Stop Mouldings 108-110
 Tongue & Groove Flooring..... 168-169

Tongue & Groove Siding 161
 Wainscot..... 153, 160-162
 Wainscot Cap 163
 Window & Door Casing 16-43
 Window Sill 128, 154, 155
 Window Stool..... 124-128

PATTERN STOCK BOARDS

Beaded Ceiling/Wainscot 153, 160-162
 Boards..... 158, 170, 244-246
 Flooring 168-169
 Paneling/Planking..... 160-162
 Roof Decking 167
 Shiplap 160
 Siding 164-166
 Standard Wood Boards..... 170
 Stepping 169
 Wainscot..... 153, 160-162

WINDOWS, DOORS CABINETRY & OTHER MILLWORK

Architectural Hardware..... 230
 Cabinets 254-258
 Columns..... 248-249
 Door Handling Instructions 232
 Doors – Commercial 234-238
 Doors – Hollow Metal 234, 238
 Doors – Residential..... 220-229
 Exterior Trim 148-158, 244-246
 Flexible Moulding..... 242
 Hardware 230-231, 235-237
 Hardwood Millwork..... 243
 Pocket Door Hardware..... 229
 PVC Boards & Panels..... 244
 Shutters..... 250-251
 Windows 204-218

P A T T E R N I N D E X

We have arrived at a numbering system for our mouldings by grouping like mouldings in a series. For example, the 100 series is casing related moulding; the 200 series is base related moulding and so on. You will find that this index is streamlined for ordering your mouldings.

PAT.	PAGE	PAT.	PAGE	PAT.	PAGE
KB100	34	KB195	120	KB267	52
KB102	21	KB196	20, 41	KB270	105
KB103	21	KB197	41	KB275	105
KB104	22	KB198	41	KB280	105
KB105	34	KB199	20, 41	KB285	105
KB106	22	KB200	58	KB290	61
KB107	29, 47	KB202	58	KB292	61
KB108	29, 47	KB205	35, 58	KB293	53
KB109	25	KB210	60	KB295	58
KB110	34	KB210U	138	KB300	91
KB111	29, 47	KB212	61	KB303	91
KB112	25	KB212U	137	KB305	91
KB113	24	KB215	60	KB307	89
KB114	24	KB215U	136	KB308	89
KB115	35	KB217	61	KB310	89
KB116	23	KB217U	137	KB311	68
KB117	23	KB220	59	KB312	77
KB118	26	KB221	56, 88, 101	KB313	68
KB119	26	KB222	45	KB314	64
KB120	39	KB223	46	KB315	79
KB122	27	KB224	53	KB316	67
KB123	28	KB225	59	KB317	66
KB125	39	KB226	46	KB318	66
KB126U	39, 135	KB227	44	KB319	69
KB130	36	KB228	48	KB320	79
KB130U	134	KB229	48	KB321	69
KB132	36	KB230	59	KB324	70
KB132U	134	KB231	44	KB325	78
KB133	38	KB232	45	KB325U	139
KB135	38	KB233	49	KB326	67
KB136	16	KB234	49	KB327	69, 87
KB137	16	KB235	57	KB329	68
KB138	17	KB240	57	KB330	78
KB139	17	KB241	56	KB331U	75, 142
KB140	38	KB242	56, 102	KB332	75
KB142	37	KB243	55, 90, 101	KB334U	75, 142
KB145	37	KB244	54, 102	KB335	77
KB145U	135	KB245	57	KB336	70
KB150	40	KB246	53, 101	KB340	76
KB155	40	KB247	57	KB340U	139
KB160	37	KB248U	57, 138	KB341	71
KB161	30	KB249	54, 102	KB342	71
KB162	30	KB250	110	KB345	76
KB163	31	KB251	55, 90, 102	KB345U	140
KB164	31	KB252	32, 50	KB350	76
KB165	93	KB253	32, 50	KB350U	140
KB170	92	KB254	32, 51	KB352	77
KB172	93	KB255	105	KB352U	141
KB175	92	KB256	51	KB353	65
KB180	40	KB260	105	KB354	64
KB185	40	KB265	105	KB355	81
KB190	120	KB266	52	KB357	90



PATTERN INDEX *continued*

PAT.	PAGE	PAT.	PAGE	PAT.	PAGE
KB358	90	KB605	110	KB879	100
KB359	90	KB610	110	KB880	101
KB360	81	KB615	110	KB881	99
KB361	65	KB630	109	KB882	99
KB362	81	KB635	109	KB883	53, 101
KB365	81	KB640	109	KB895	129
KB368	81	KB645	108	KB900	161
KB370	80	KB650	108	KB902	161
KB375	80	KB654	100, 115	KB904	161
KB376	33, 97	KB655	108	KB904PVC	153
KB378	74	KB657	115	KB906	161
KB379	74	KB658	108	KB908	160
KB380	80	KB660	116	KB908PVC	153
KB381	73	KB665	116	KB910	161
KB384	73	KB670	116	KB912	161
KB385	87	KB685	115	KB914	160
KB386	72	KB686	115	KB915	160
KB387	72	KB700	122	KB916	164
KB389	88	KB705	122	KB918	164
KB390	88	KB710	122	KB920	164
KB392	88	KB715	123	KB922	165
KB393	88	KB720	123	KB924	165
KB394	88	KB725	126	KB925	165
KB400	98	KB730	127	KB926	166
KB401	18, 95	KB735	127	KB927	166
KB402	20, 94	KB740	127	KB928	166
KB403	95	KB745	126	KB930	160
KB404	19, 94	KB750	126	KB932	167
KB405	98	KB755	124	KB934	168
KB406	18, 96	KB760	124	KB935OAK	168
KB407	19, 97	KB765	124	KB936	168
KB409U	98, 136	KB770	124	KB938	169
KB410	98	KB775	125	KB938MAH	169
KB415	106	KB780	125	KB940	169
KB420	107	KB785	130	KB942	169
KB425	107	KB786	130	PB518	131
KB430OAK	106	KB787	130	PB550	131
KB445	117	KB790	128	PVC5041	148
KB450	117	KB795	128	PVC5045	149
KB455	117	KB796	129	PVC5047	149
KB465	118	KB797	129	PVC5049	148
KB470	118	KB799	130	PVC5063	149
KB480	113	KB805	163	PVC5075	151
KB485	113	KB808	41, 163	PVC5150	151
KB500	112	KB810	163	PVC5158	150
KB505	112	KB815	120	PVC5164	151
KB510	112	KB825	119	PVC5168	151
KB515	112	KB840	119	PVC5180	152
KB520	112	KB845	103	PVC5210	150
KB525	112	KB855	121	PVC5234	152
KB530	112	KB860	121	PVC5245	151
KB535	111	KB865	121	PVC5283	152
KB540	111	KB870	103	PVC5287	150
KB545	111	KB871	100	PVC5311	154
KB550	111	KB872	103	PVC7435	154
KB555	111	KB873	100	PVC7650	154
KB560	114	KB874	55, 99	PVC7931	152
KB565	114	KB875	103	PVC7962	150
KB570	114	KB876	54, 99	PVC9608	155
KB600	110	KB878	100	Skirl Wavy Edge Siding	165

M O U L D I N G S

The following moulding section represents our stock patterns and indicates the various species and types of wood in-stock or readily available. For radiused or arched applications, we offer Duraflex flexible moulding or can custom mill from MDF or poplar. We have made every attempt to show the profiles as accurately as possible in our continuing goal of excellence.

While we show and offer many different moulding patterns in our catalog, we realize there may be occasions when the individual preference is for something slightly different. Custom made mouldings are available in different profiles and different species of wood. We can certainly accommodate your requirements.





Door & Window Casing

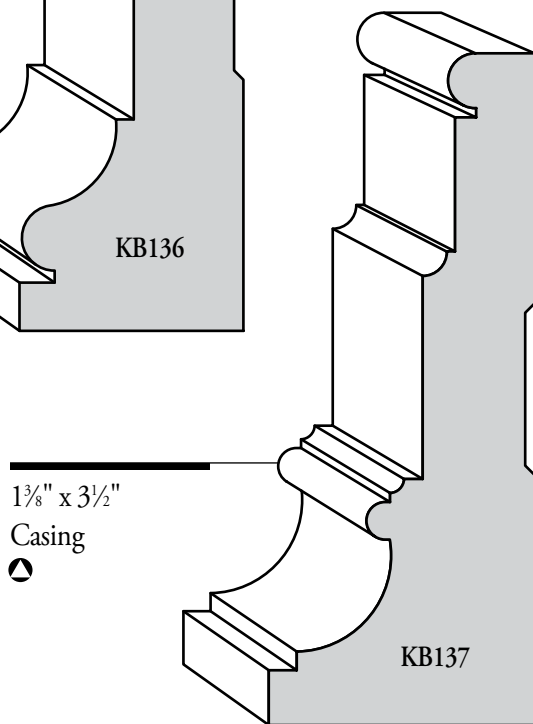
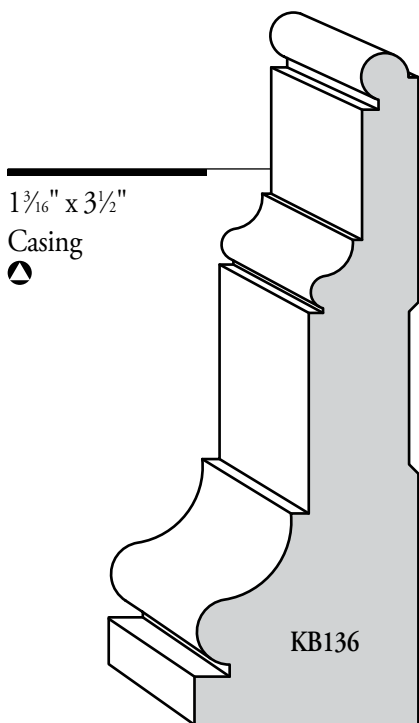

● Clear Pine

○ Primed FJ Pine

● Primed FJ Poplar

● Lightweight Primed MDF



Door & Window Casing

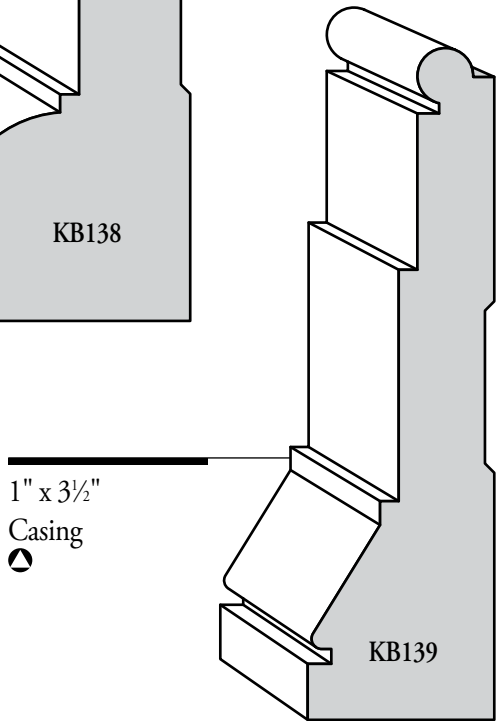
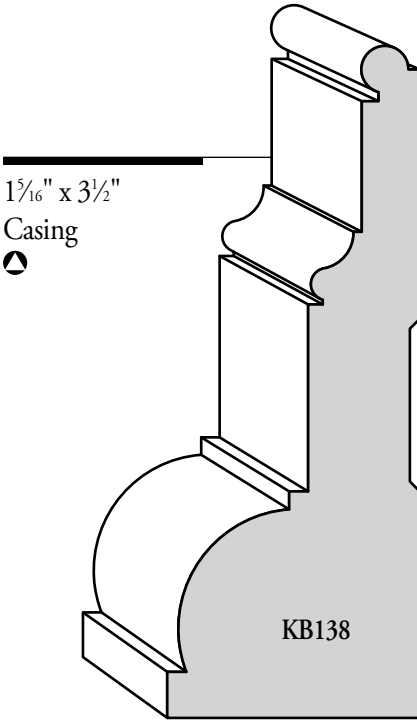

● Clear Pine

○ Primed FJ Pine

▲ Primed FJ Poplar

☛ Lightweight Primed MDF



Door & Window Casing

1 1/16" x 3 1/2"

Casing

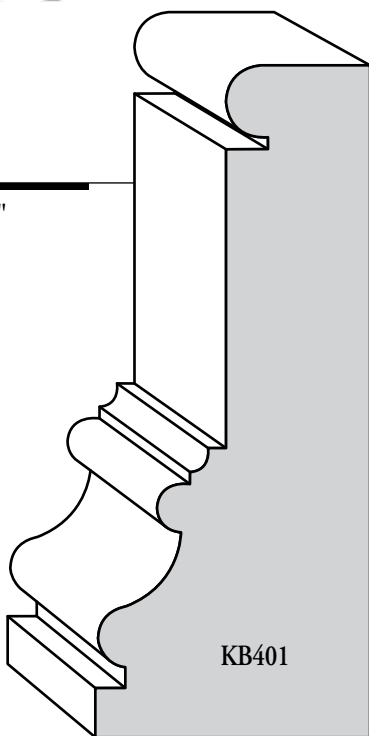

1 1/16" x 3 1/2"

Casing

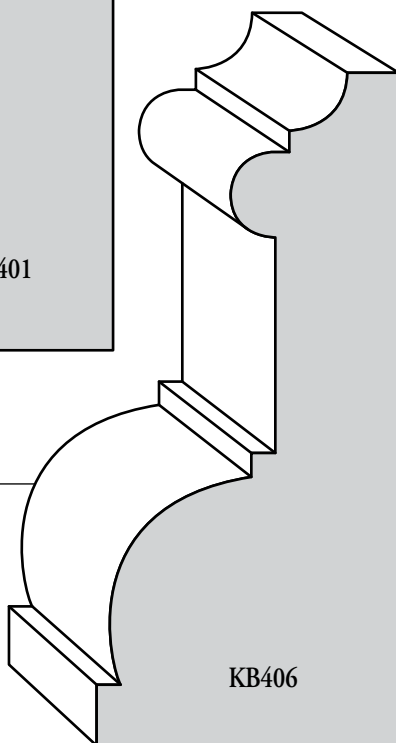

● Clear Pine

○ Primed FJ Pine

▲ Primed FJ Poplar

☛ Lightweight Primed MDF



Door & Window Casing

1 1/4" x 3 1/2"

Casing

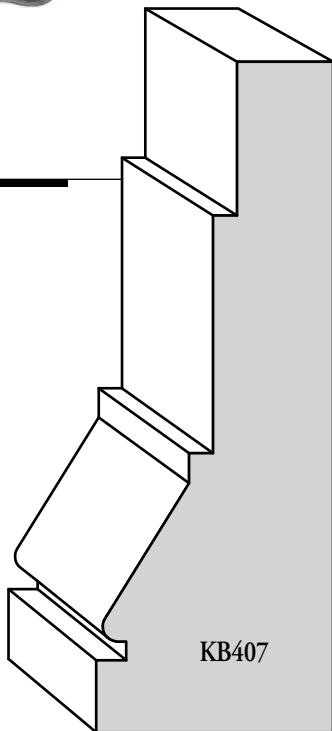

1 13/16" x 4 1/8"

Casing

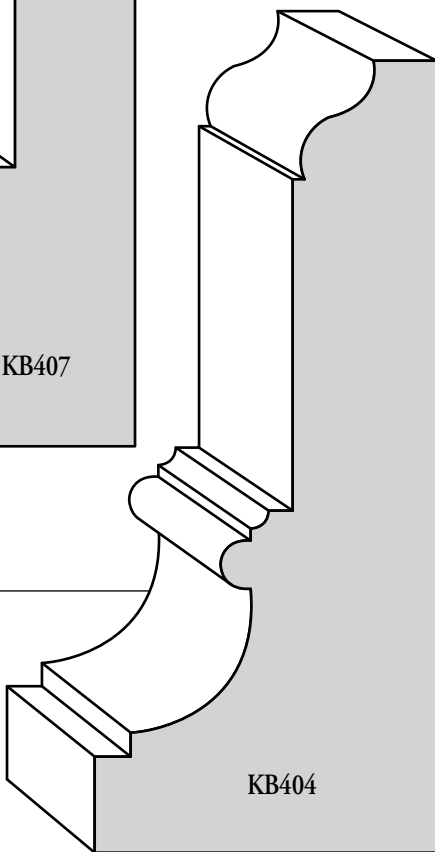

● Clear Pine

○ Primed FJ Pine

● Primed FJ Poplar

🍃 Lightweight Primed MDF



Door & Window Casing

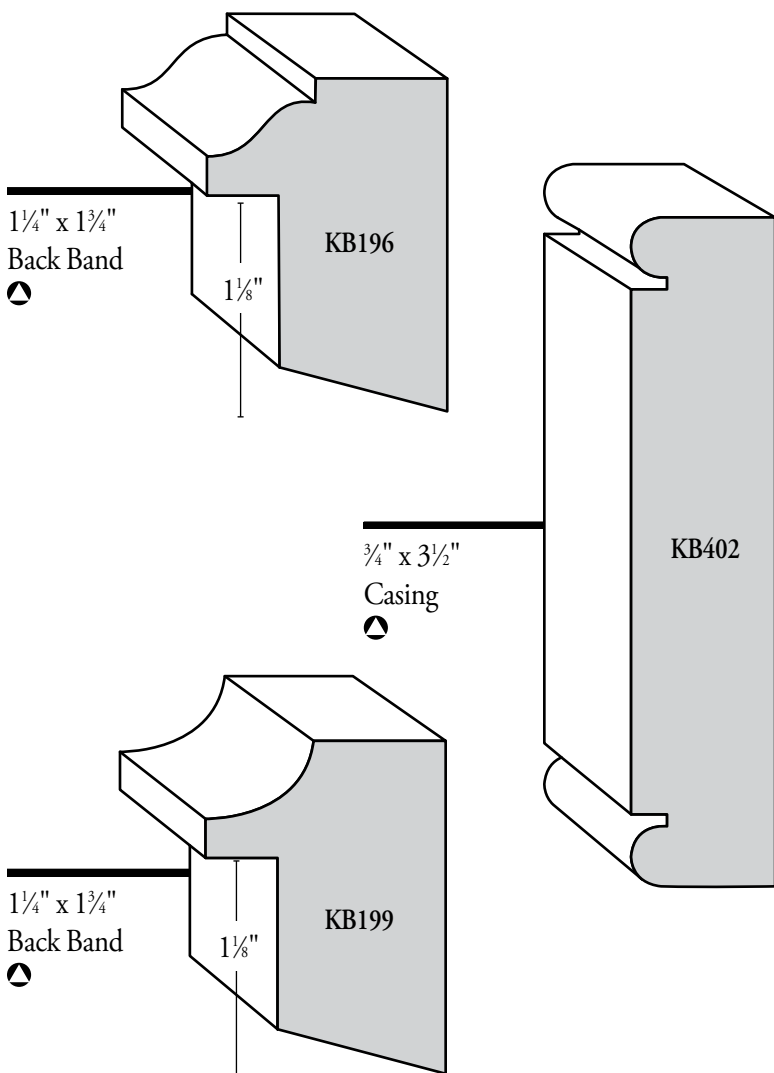

- Clear Pine
- Primed FJ Pine
- ▲ Primed FJ Poplar
- Lightweight Primed MDF



Door & Window Casing

1 1/2" x 4 1/2"

Casing



Matching 3-1/2"
Casing: KB136

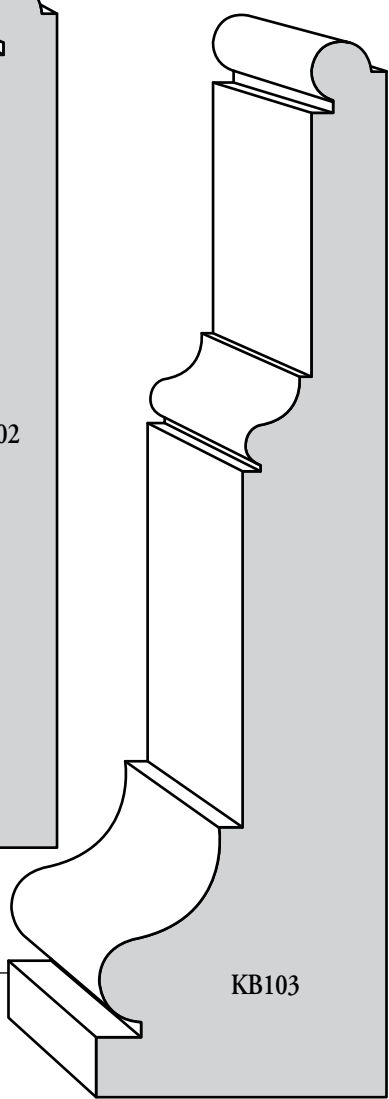
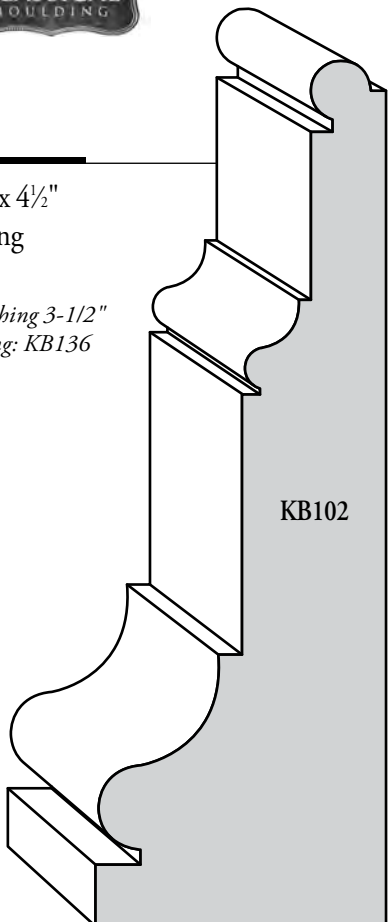

1 1/2" x 5 1/2"

Casing



- Clear Pine
- Primed FJ Pine
- ▲ Primed FJ Poplar
- 🍃 Lightweight Primed MDF



Door & Window Casing

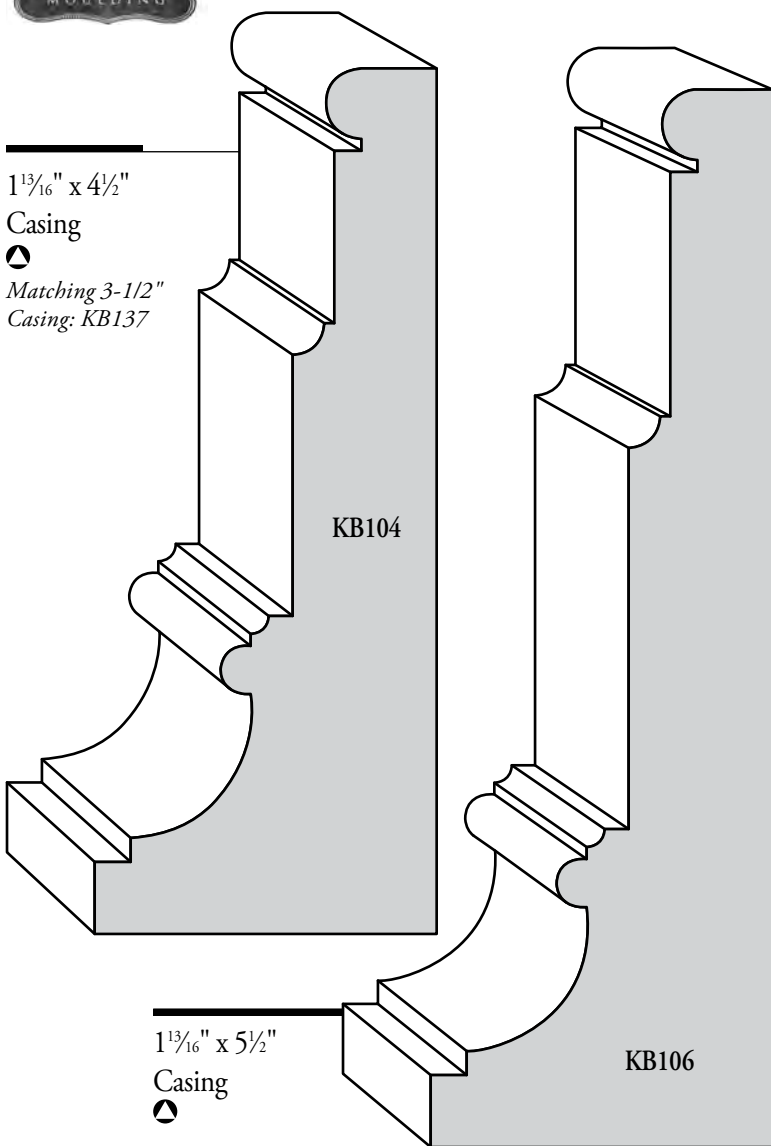

- Clear Pine
- Primed FJ Pine
- ▲ Primed FJ Poplar
- ♣ Lightweight Primed MDF



Door & Window Casing

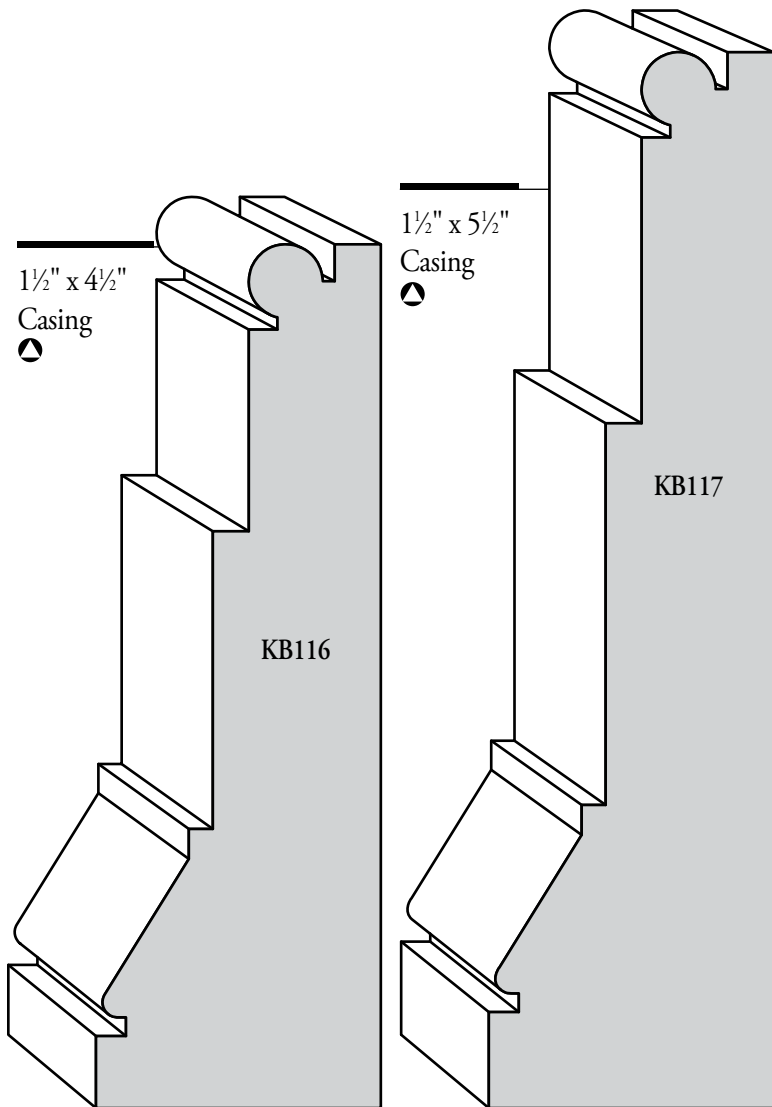

● Clear Pine

○ Primed FJ Pine

▲ Primed FJ Poplar

☙ Lightweight Primed MDF



Door & Window Casing

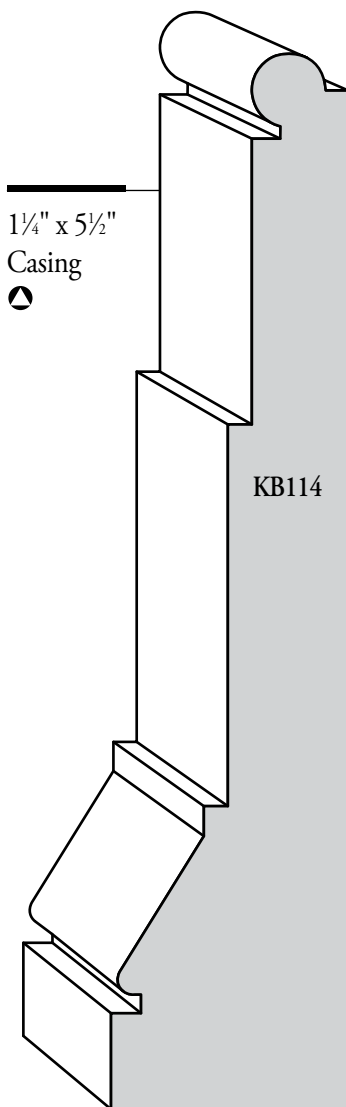
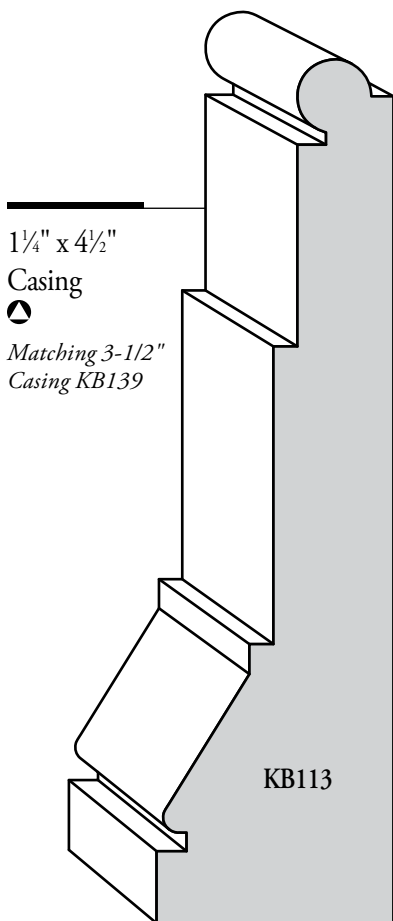



Door & Window Casing

1¹/₁₆" x 4¹/₂"

Casing



Matching 3-1/2"
Casing: KB138

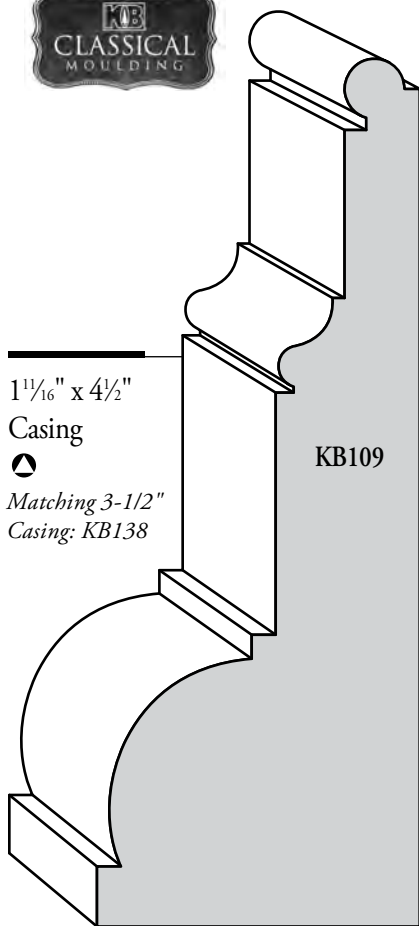

KB109

KB112

1¹/₁₆" x 5¹/₂"

Casing

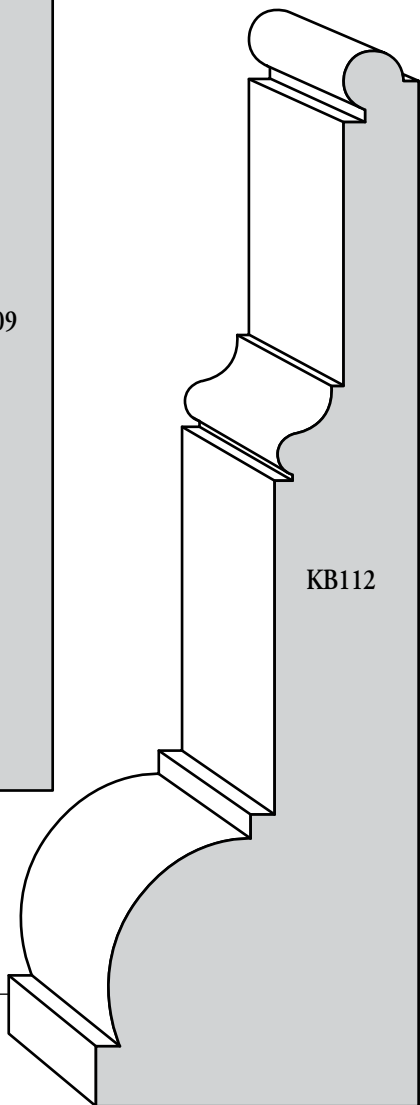

● Clear Pine

○ Primed FJ Pine

▲ Primed FJ Poplar

✎ Lightweight Primed MDF



Door & Window Casing

1¹¹/₁₆" x 4¹/₂"

Casing



Matching 3-1/2"

Casing: KB401

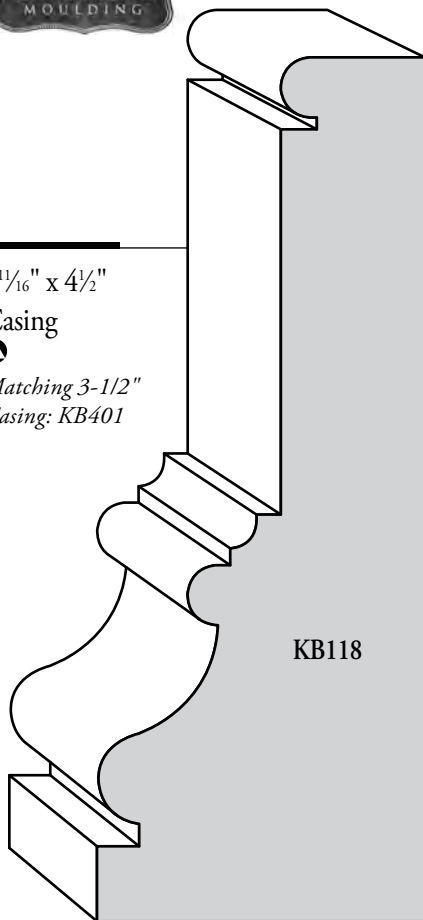

KB119

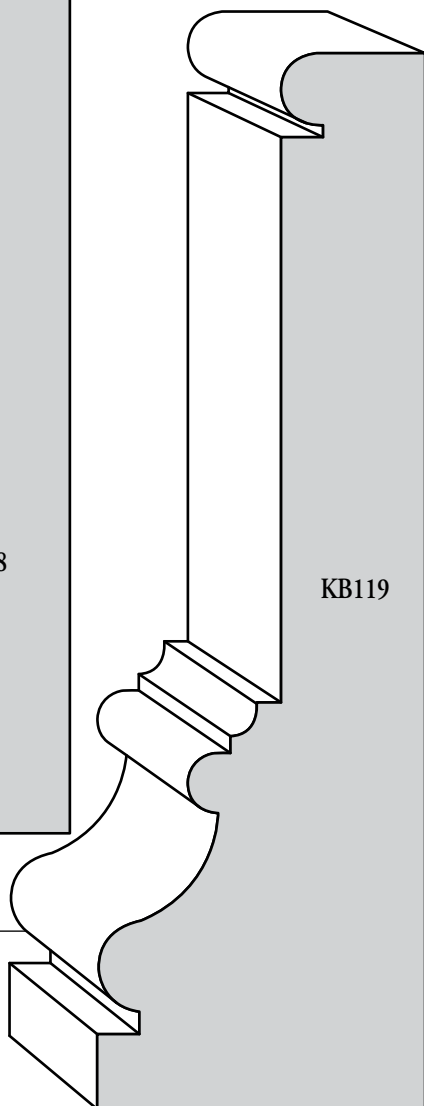

1¹¹/₁₆" x 5¹/₂"

Casing



● Clear Pine

○ Primed FJ Pine

▲ Primed FJ Poplar

■ Lightweight Primed MDF



Door & Window Casing

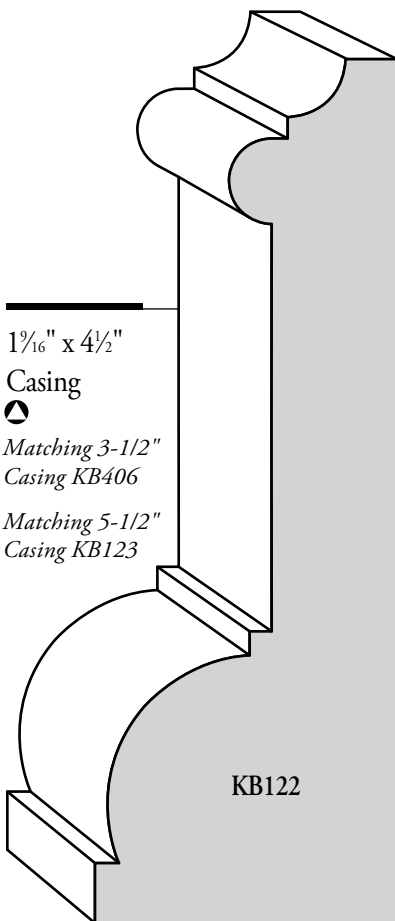

 Clear Pine

 Primed FJ Pine

 Primed FJ Poplar

 Lightweight Primed MDF



Door & Window Casing

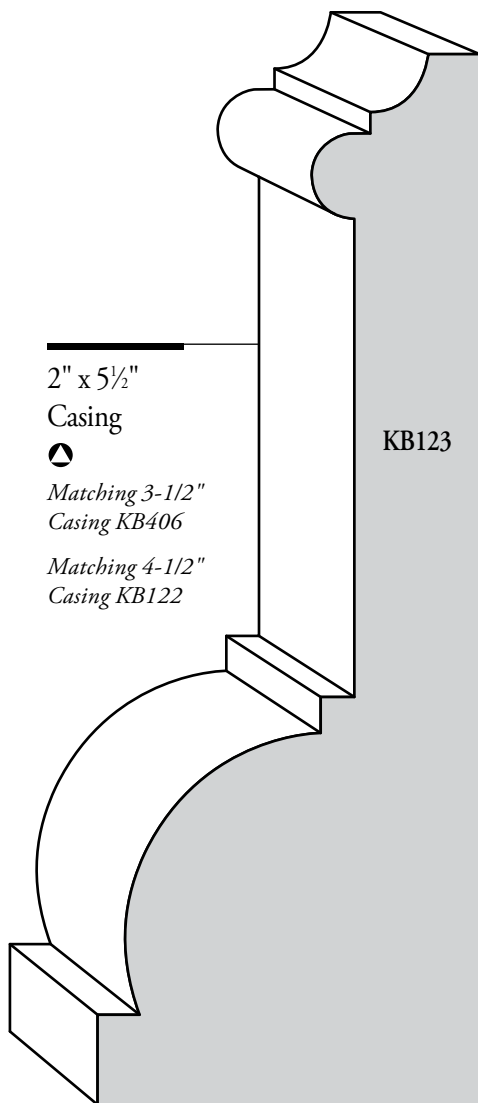

2" x 5 1/2"
Casing



*Matching 3-1/2"
Casing KB406*

*Matching 4-1/2"
Casing KB122*

KB123

● Clear Pine

○ Primed FJ Pine

▲ Primed FJ Poplar

☛ Lightweight Primed MDF



Door & Window Casing

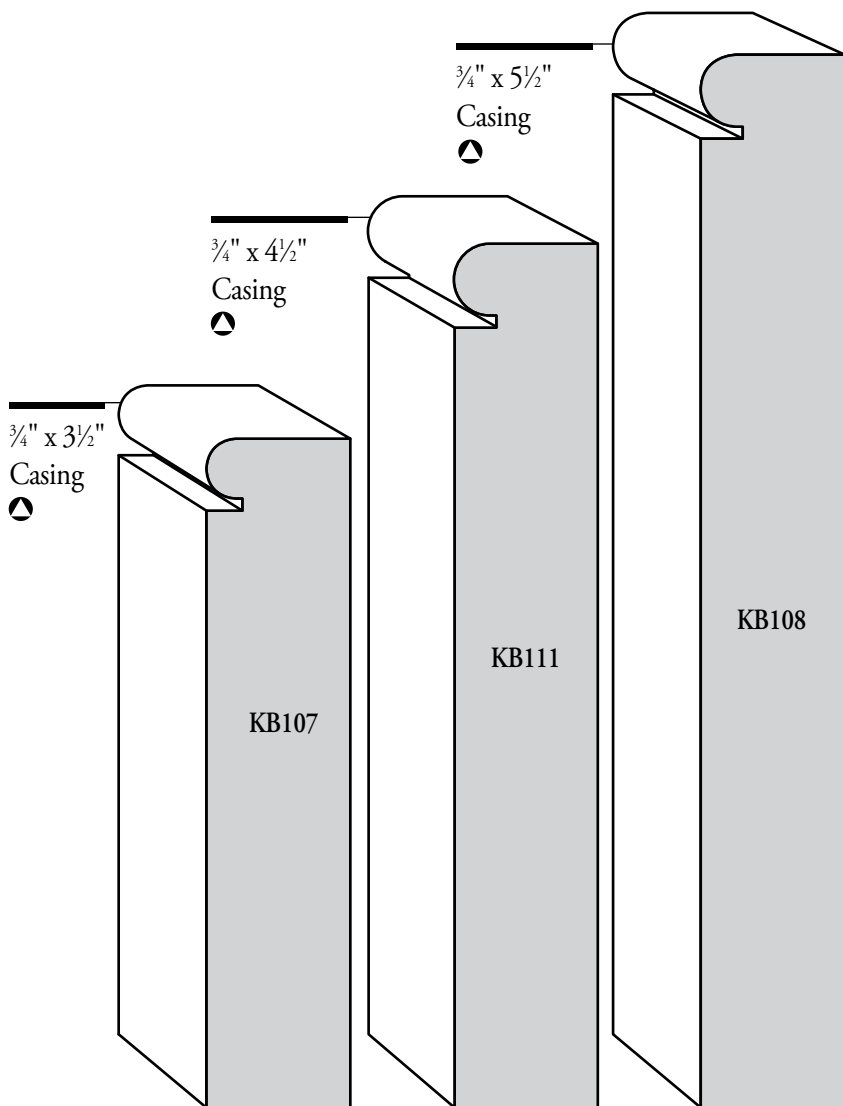

- Clear Pine
- Primed FJ Pine
- ▲ Primed FJ Poplar
- ✎ Lightweight Primed MDF

Door & Window Casing

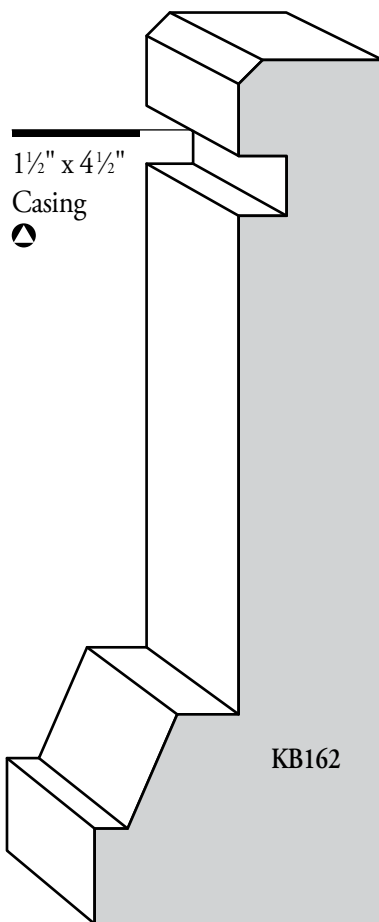
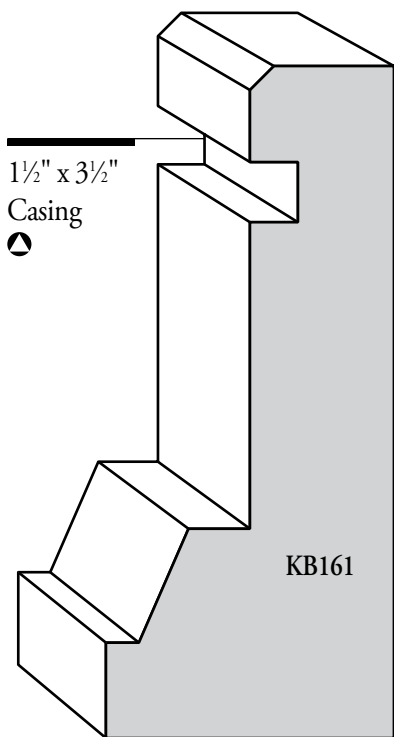

Door & Window Casing

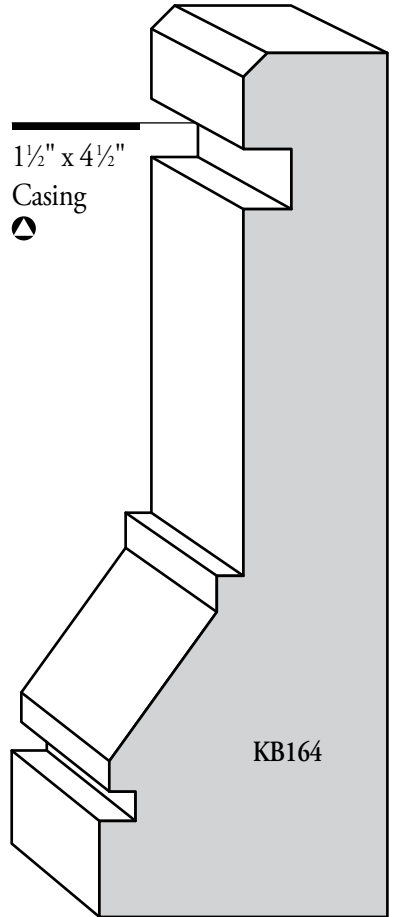
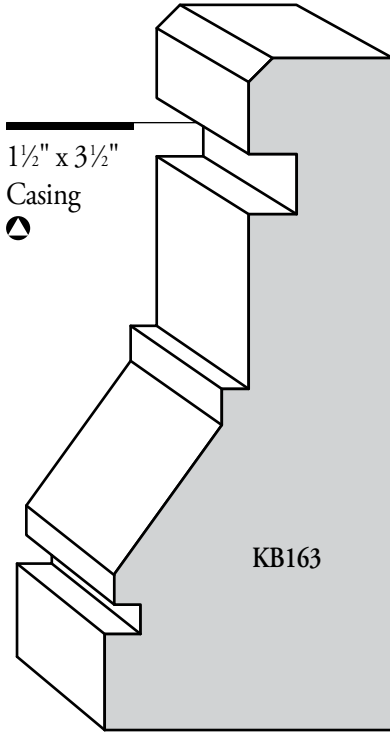

● Clear Pine

○ Primed FJ Pine

▲ Primed FJ Poplar

🍃 Lightweight Primed MDF

KUIKEN BROTHERS
MODERN CRAFTSMAN
MOULDING COLLECTION

Door & Window Casing

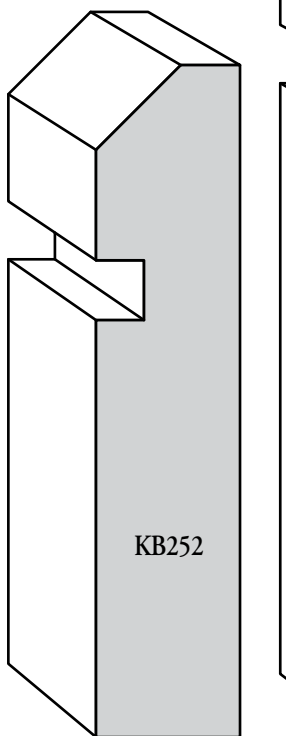

KB252

$\frac{3}{4}$ " x $3\frac{1}{2}$ "

Casing/Base

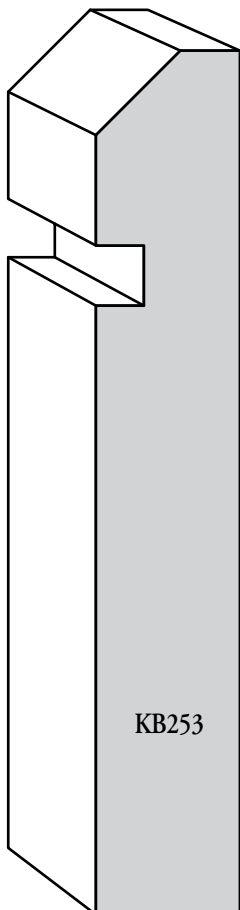

KB253

$\frac{3}{4}$ " x $4\frac{1}{2}$ "

Casing/Base



KB254

$\frac{3}{4}$ " x $5\frac{1}{2}$ "

Casing/Base



● Clear Pine

○ Primed FJ Pine

▲ Primed FJ Poplar

♣ Lightweight Primed MDF

KUIKEN BROTHERS
MODERN CRAFTSMAN
MOULDING COLLECTION

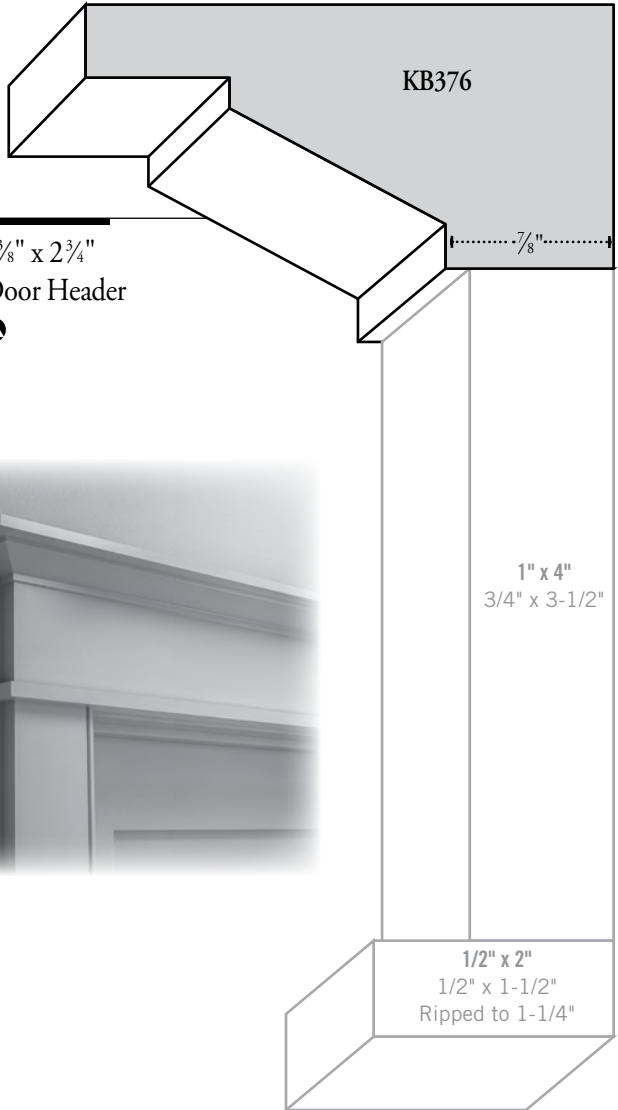

Door & Window Casing

$1\frac{1}{16}$ " x $2\frac{1}{4}$ "
Colonial Casing

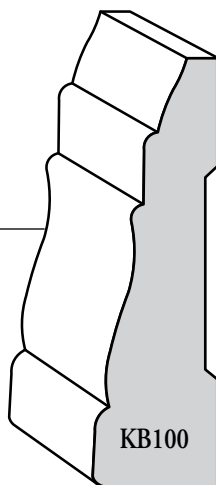

$1\frac{1}{16}$ " x $2\frac{1}{2}$ "
Colonial Casing

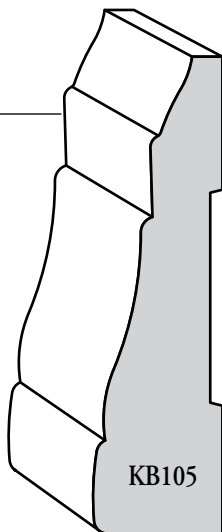

$1\frac{1}{16}$ " x $3\frac{1}{2}$ "
Colonial Casing

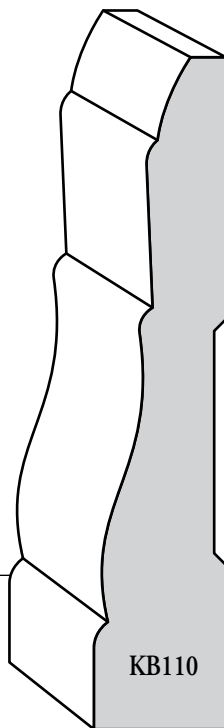

● Clear Pine

○ Primed FJ Pine

▲ Primed FJ Poplar

■ Lightweight Primed MDF

Door & Window Casing

1" x 3 3/4"
Colonial Casing
○

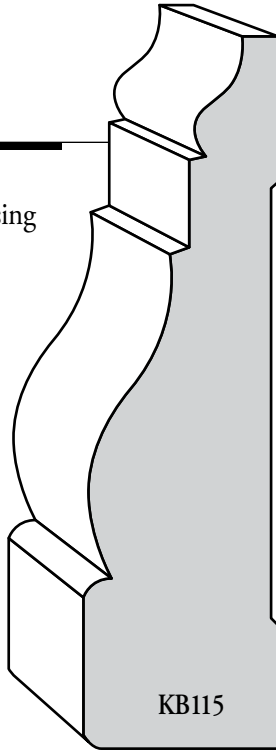

1 1/16" x 3 1/2"
Colonial Casing/Base
○

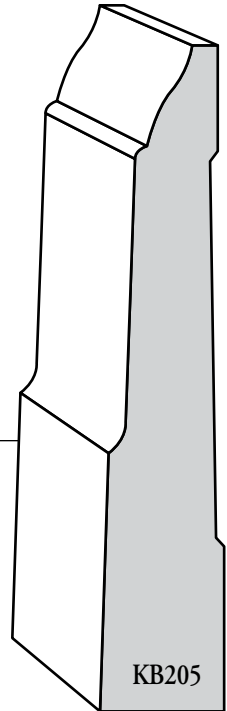

● Clear Pine

○ Primed FJ Pine

▲ Primed FJ Poplar

☙ Lightweight Primed MDF

Door & Window Casing

$\frac{13}{16}$ " x $3\frac{1}{2}$ "

Heavy Beaded
Colonial Casing

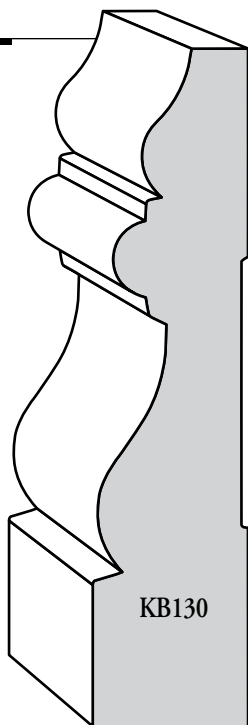

KB130

1" x $4\frac{1}{4}$ "

Heavy Beaded Colonial Casing

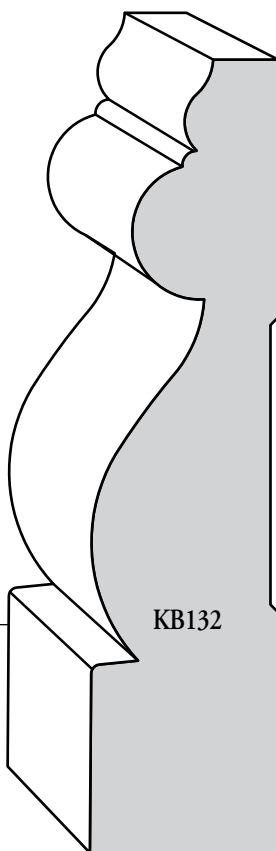

KB132

● Clear Pine

○ Primed FJ Pine

▲ Primed FJ Poplar

 Lightweight Primed MDF

Door & Window Casing

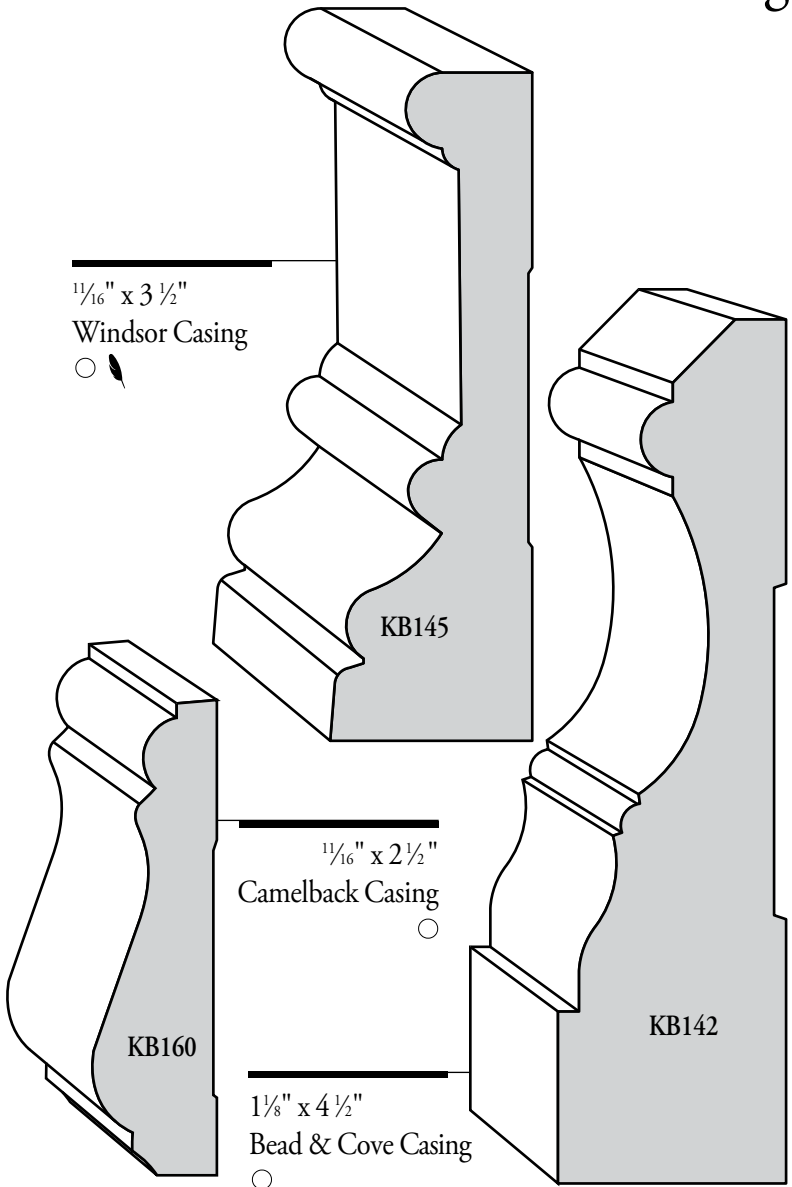

● Clear Pine

○ Primed FJ Pine

▲ Primed FJ Poplar

☛ Lightweight Primed MDF

Door & Window Casing

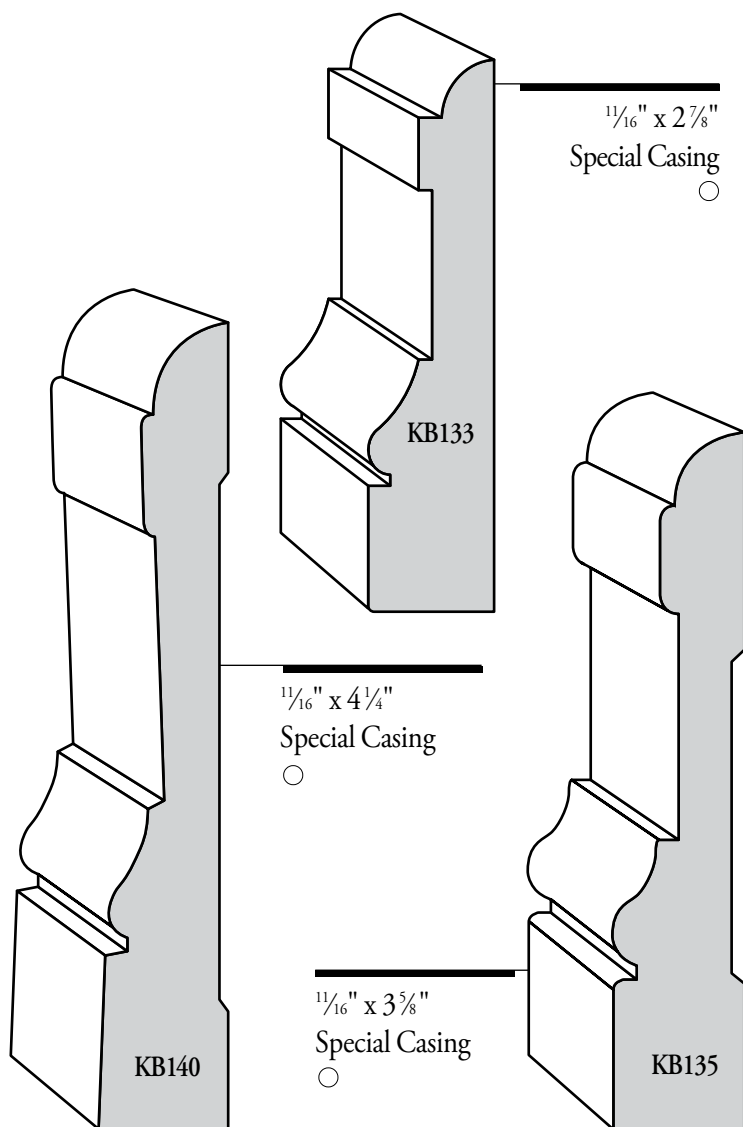

● Clear Pine

○ Primed FJ Pine

▲ Primed FJ Poplar

☛ Lightweight Primed MDF

Door & Window Casing

$\frac{1}{16}'' \times 2\frac{1}{2}''$
Beaded Colonial Casing

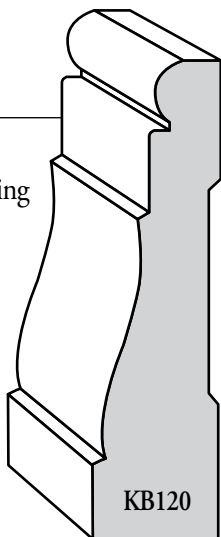

KB120

$\frac{1}{16}'' \times 3\frac{1}{2}''$
Beaded Colonial Casing

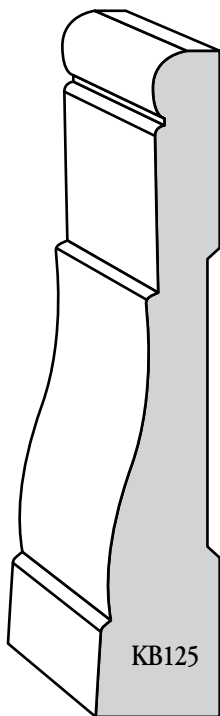

KB125

$\frac{1}{16}'' \times 3\frac{1}{2}''$
Beaded Colonial Casing

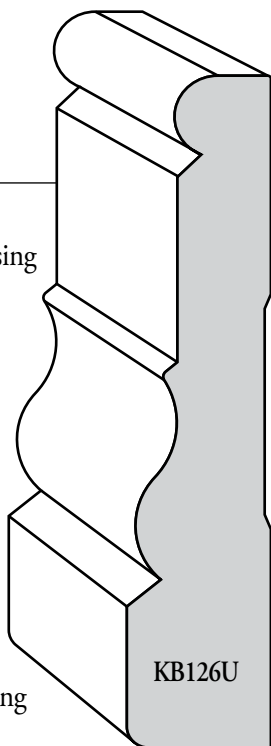

KB126U

● Clear Pine

○ Primed FJ Pine

♣ Primed FJ Poplar

♣ Lightweight Primed MDF

Door & Window Casing

$\frac{1}{16}$ " x $2\frac{1}{4}$ "

Clam Casing

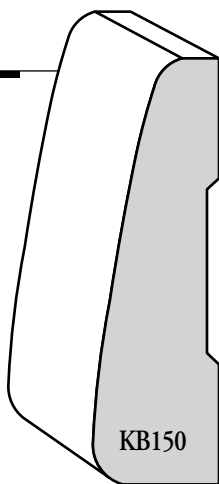

KB150

$\frac{1}{16}$ " x $2\frac{1}{2}$ "

Clam Casing

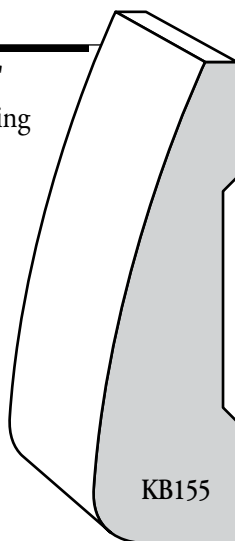

KB155

$\frac{3}{16}$ " x $3\frac{1}{2}$ "

Sanitary Casing

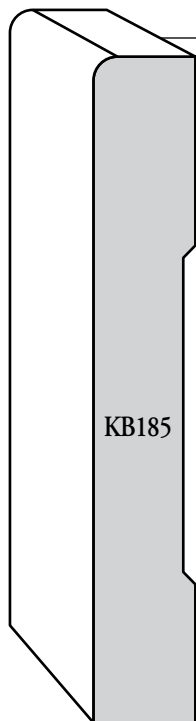

KB185

$\frac{3}{16}$ " x $2\frac{1}{2}$ "

Sanitary Casing

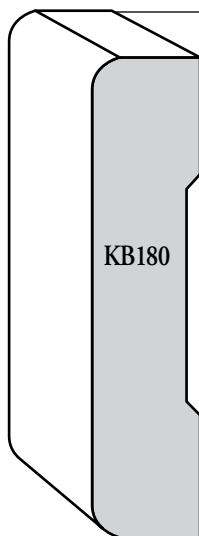

KB180

● Clear Pine

○ Primed FJ Pine

▲ Primed FJ Poplar

☛ Lightweight Primed MDF

Back Band Moulding

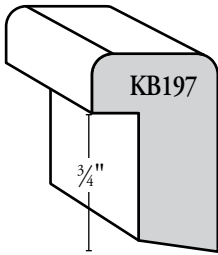

KB197

$1\frac{1}{16}$ " x 1"

Back Band



1" x $1\frac{1}{4}$ "

Back Band

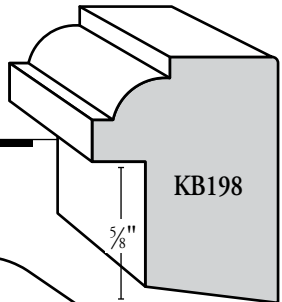

KB198

$\frac{5}{8}$ "

$1\frac{3}{4}$ " x $1\frac{3}{8}$ "
Beadboard Cap

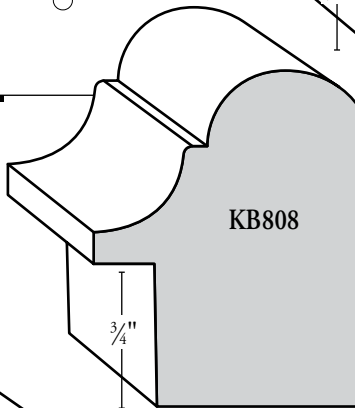

KB808

$\frac{3}{4}$ "

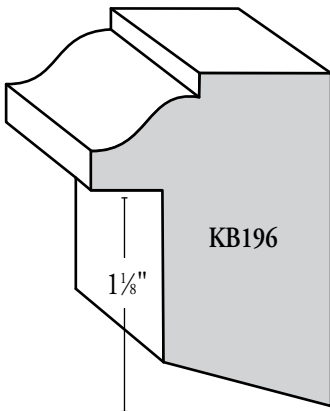

KB196

$1\frac{1}{8}$ "



$1\frac{1}{4}$ " x $1\frac{3}{4}$ "

Back Band



$1\frac{1}{4}$ " x $1\frac{3}{4}$ "

Back Band

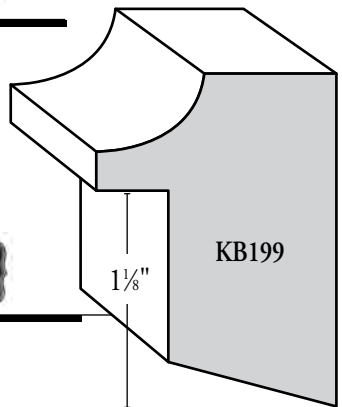

KB199

$1\frac{1}{8}$ "

● Clear Pine

○ Primed FJ Pine

▲ Primed FJ Poplar

🍃 Lightweight Primed MDF

Classical Casing

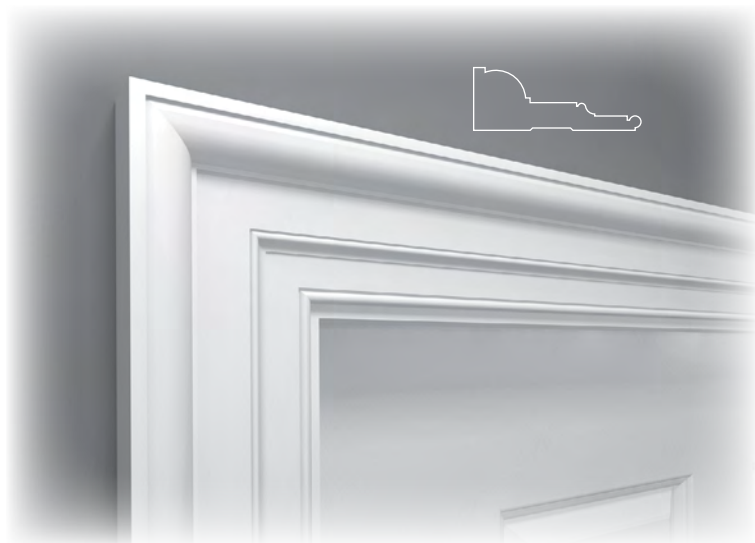

KB138 Georgian Casing (1-5/16" x 3-1/2" Poplar)

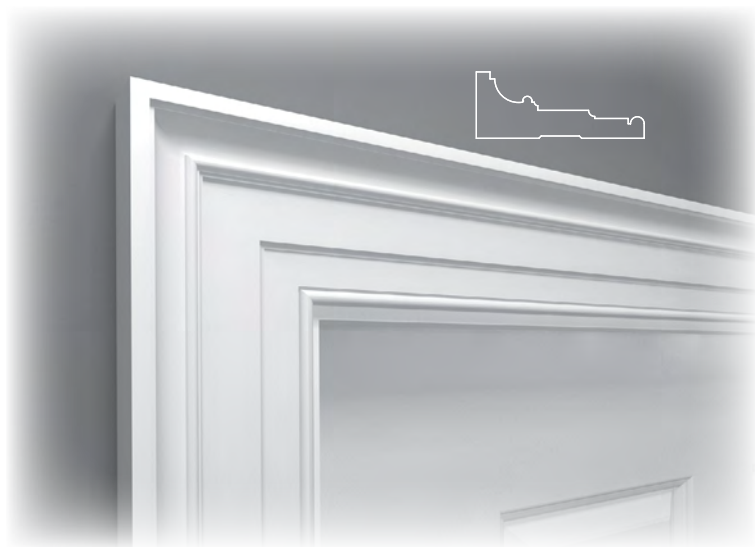

KB137 Federal Casing (1-3/8" x 3-1/2" Poplar)

Classical Casing

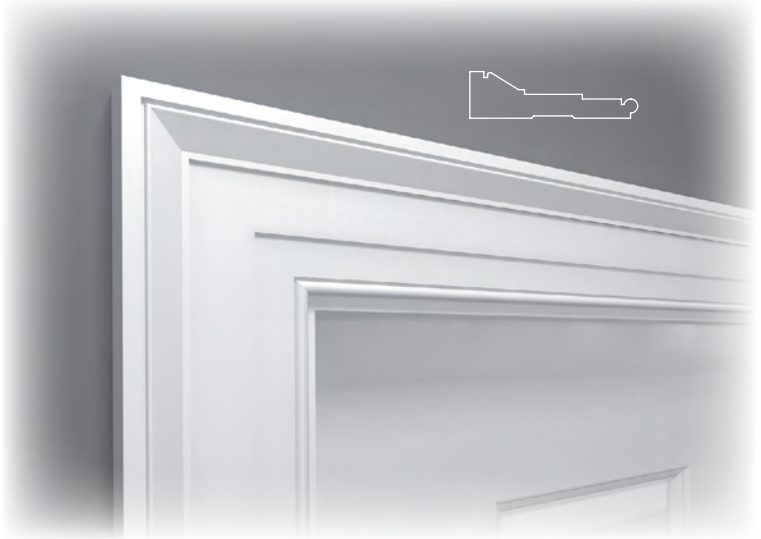

KB139 Greek Revival Casing (1" x 3-1/2" Poplar)

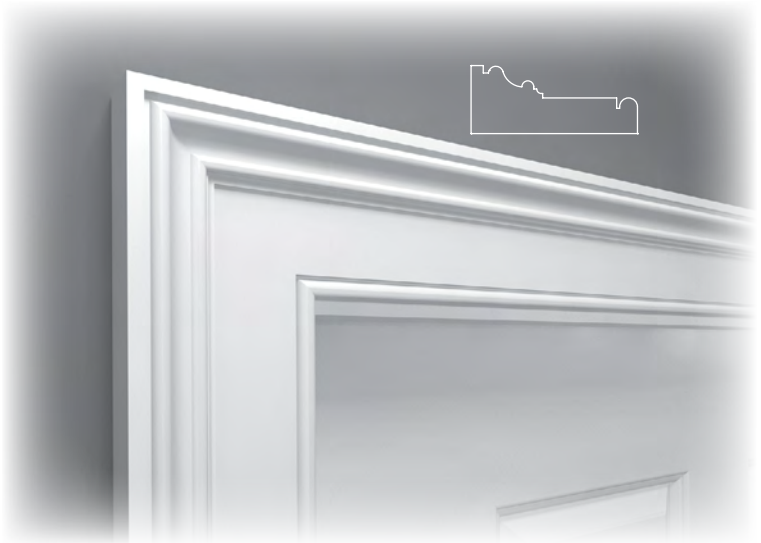

KB401 Colonial Revival Casing (1-7/16" x 3-1/2" Poplar)



Base Mouldings

1 1/16" x 9"

Base



*Matching
Base Cap:
KB249*

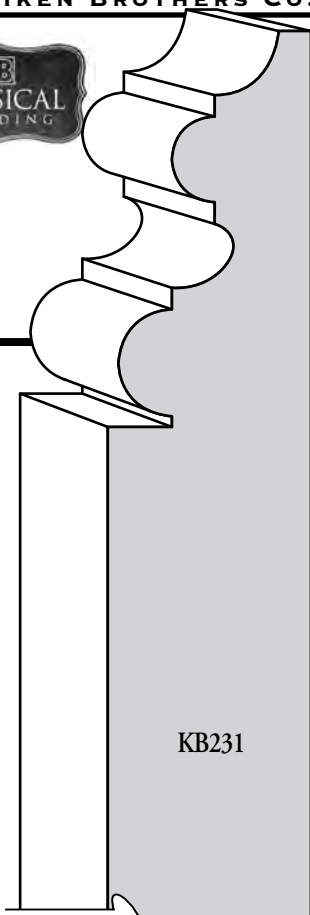

KB231

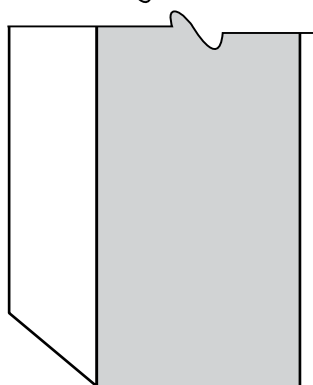

3/4" x 7 1/2"

Base



*Matching
Base Cap:
KB244*



KB227

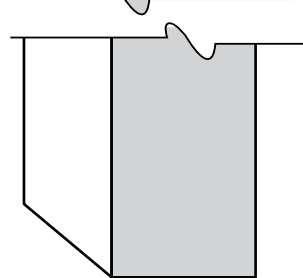

● Clear Pine

○ Primed FJ Pine

▲ Primed FJ Poplar

☛ Lightweight Primed MDF



Base Mouldings

1" x 6½"

Base



*Matching
Base Cap:
KB243*

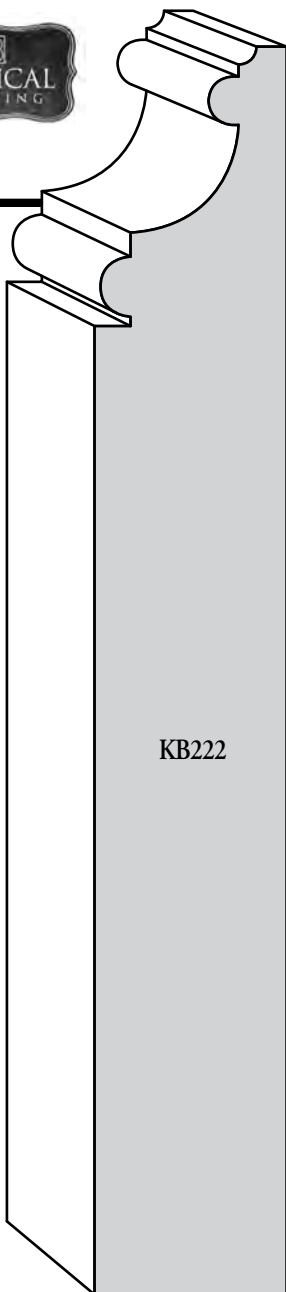

KB222

1¼" x 5½"

Base



*Matching Base Cap:
KB241 *not identical*

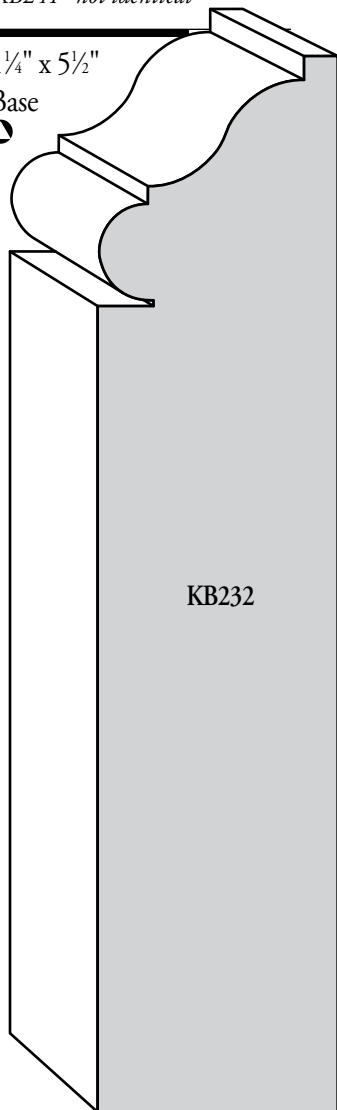

KB232

● Clear Pine

○ Primed FJ Pine

▲ Primed FJ Poplar

🍃 Lightweight Primed MDF



Base Mouldings

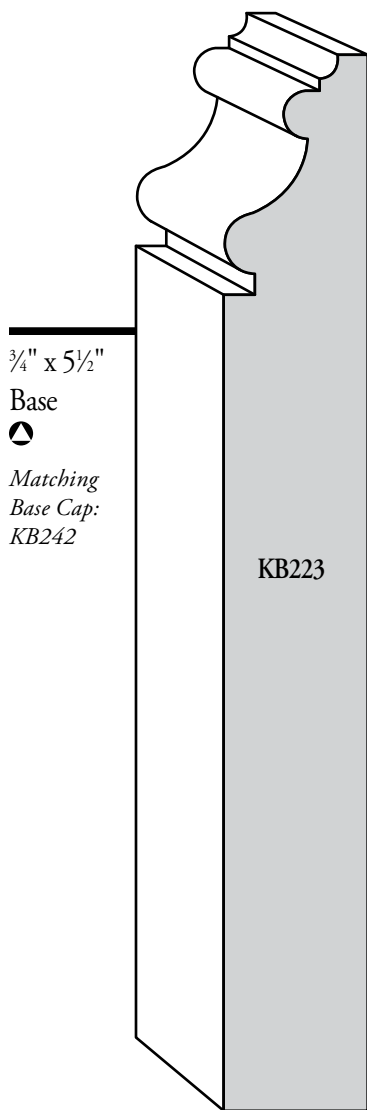

$\frac{3}{4}$ " x $5\frac{1}{2}$ "

Base



*Matching
Base Cap:
KB242*

KB223

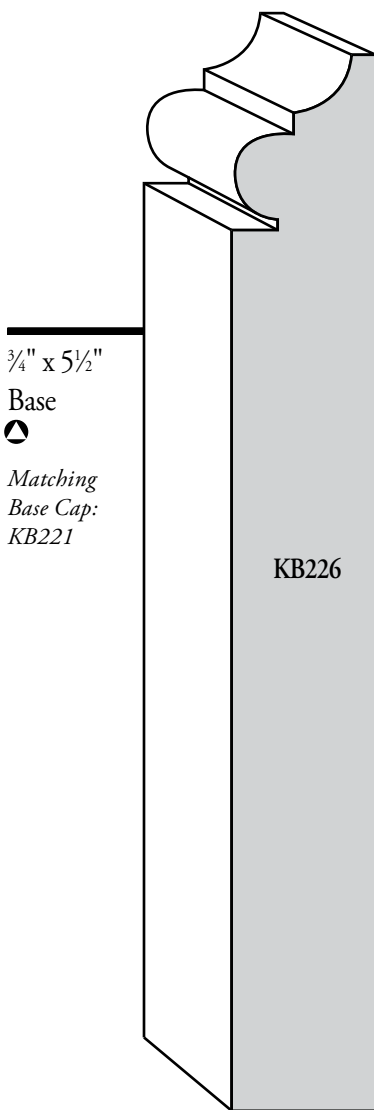

$\frac{3}{4}$ " x $5\frac{1}{2}$ "

Base



*Matching
Base Cap:
KB221*

KB226

● Clear Pine

○ Primed FJ Pine

▲ Primed FJ Poplar

☛ Lightweight Primed MDF



Base Mouldings

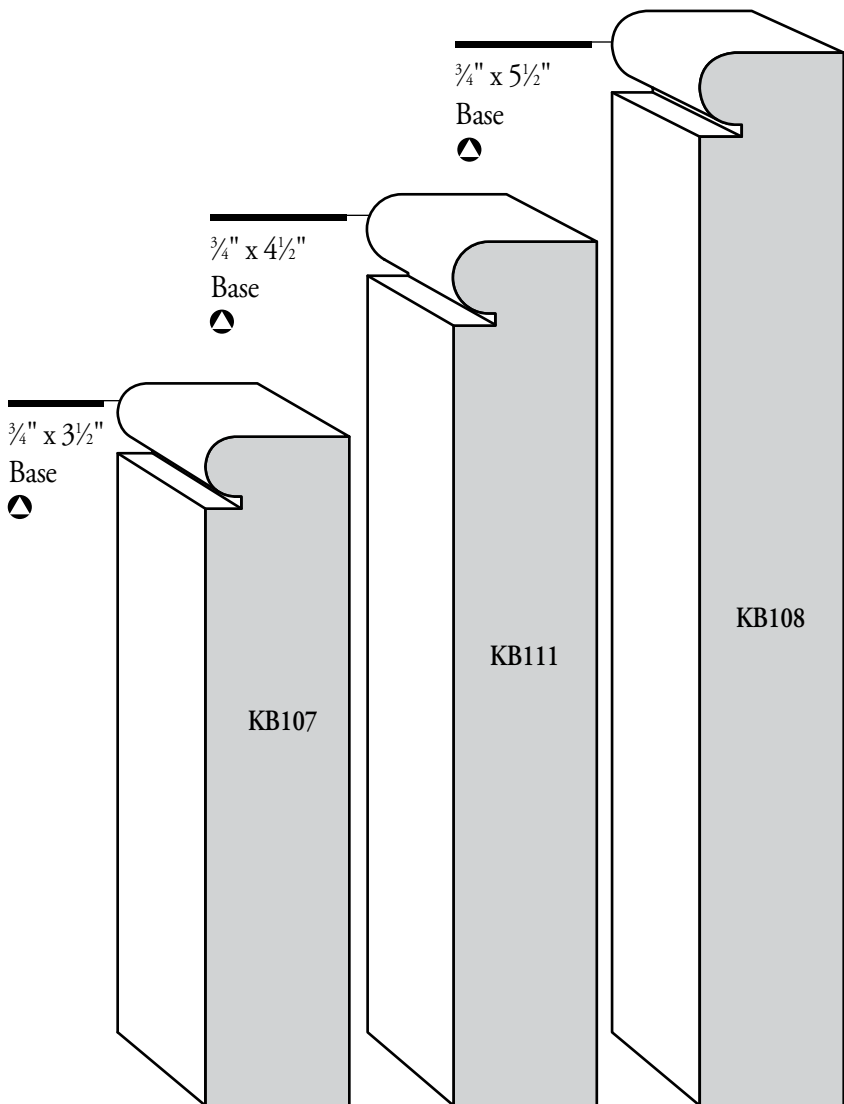



$\frac{7}{8}$ " x $7\frac{1}{2}$ "

Base

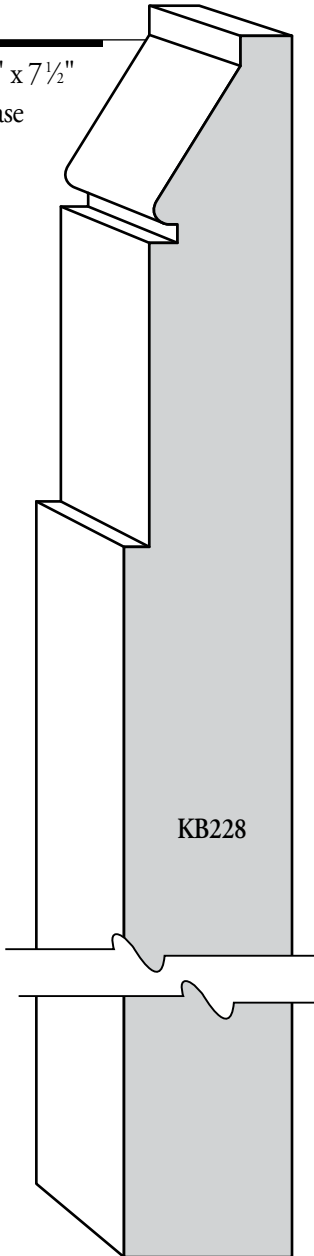

KB228

$\frac{7}{8}$ " x 9"

Base

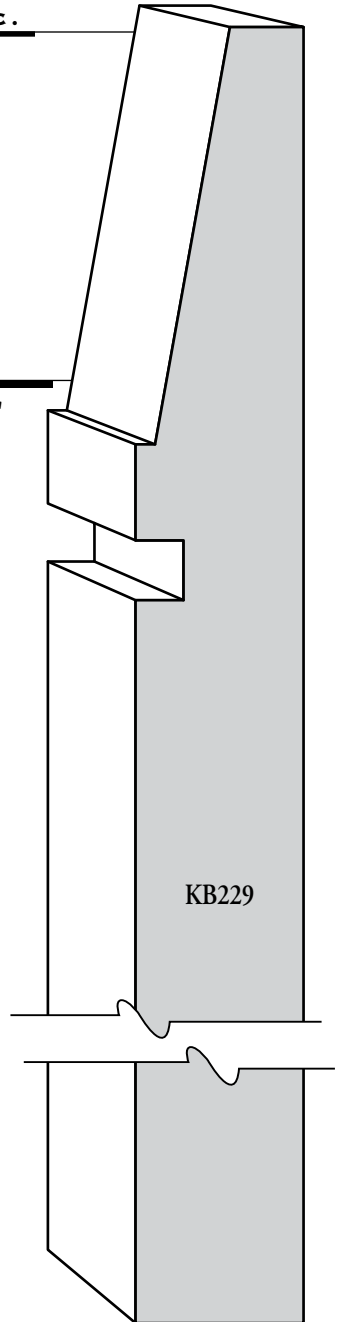

KB229

● Clear Pine

○ Primed FJ Pine

▲ Primed FJ Poplar

■ Lightweight Primed MDF

KUIKEN BROTHERS
MODERN CRAFTSMAN
MOULDING COLLECTION

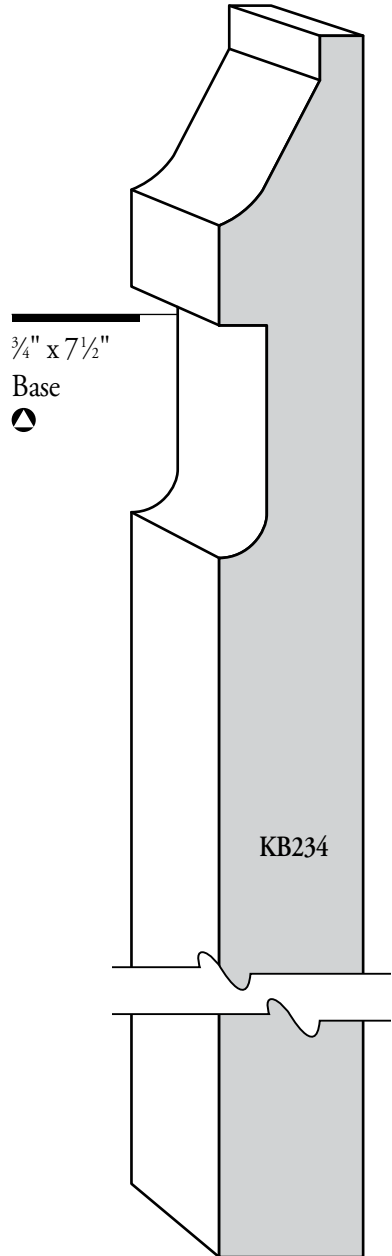
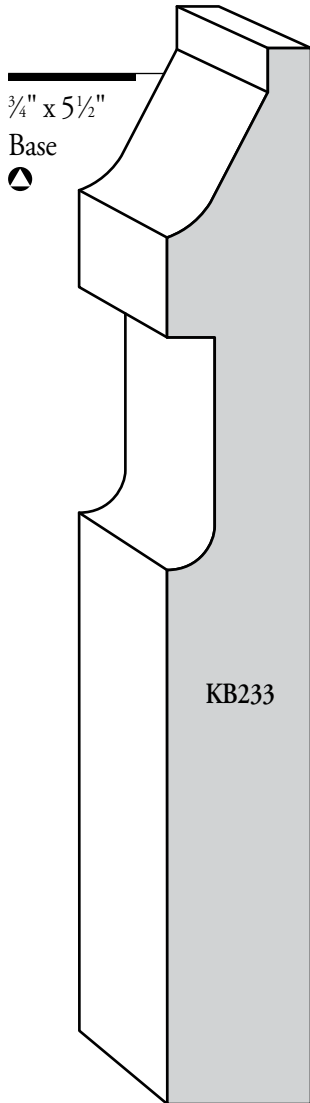

● Clear Pine

○ Primed FJ Pine

▲ Primed FJ Poplar

🍃 Lightweight Primed MDF



Base Mouldings

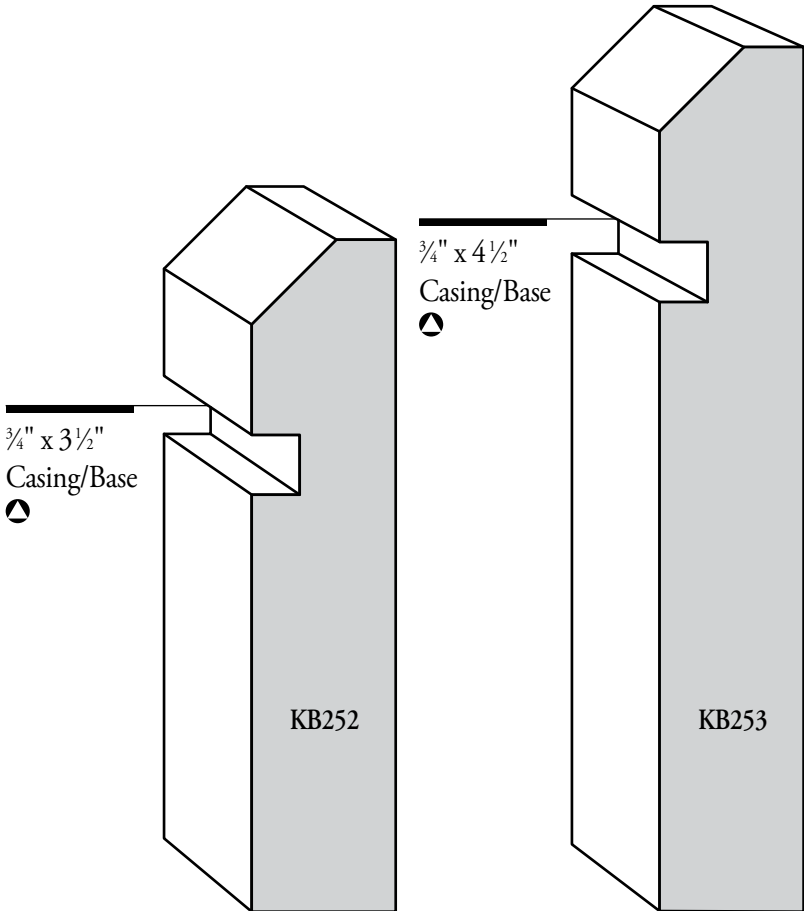

● Clear Pine

○ Primed FJ Pine

▲ Primed FJ Poplar

☛ Lightweight Primed MDF

KUIKEN BROTHERS
MODERN CRAFTSMAN
MOULDING COLLECTION

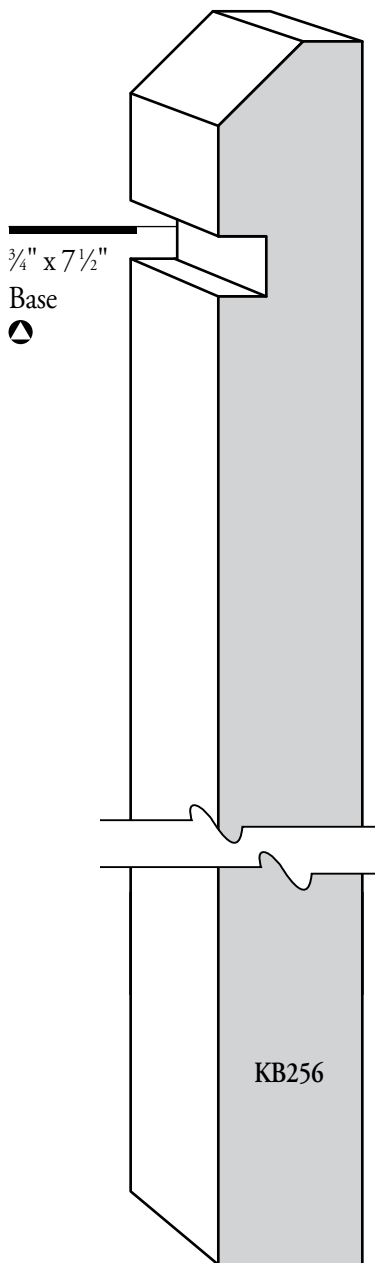
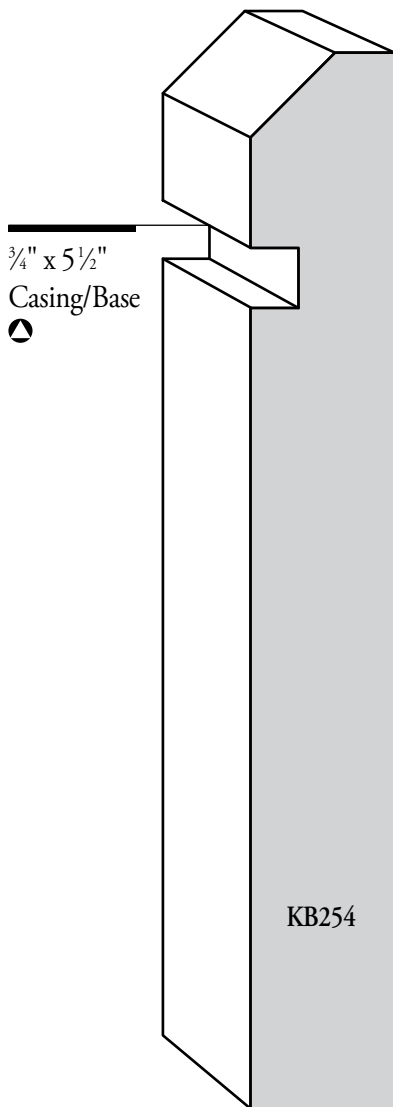

● Clear Pine

○ Primed FJ Pine

▲ Primed FJ Poplar

☛ Lightweight Primed MDF

KUIKEN BROTHERS
MODERN CRAFTSMAN
MOULDING COLLECTION

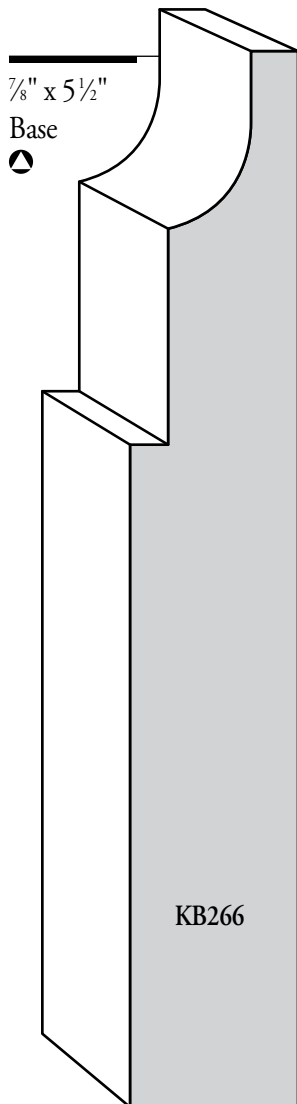

7/8" x 7 1/2"
Base
▲

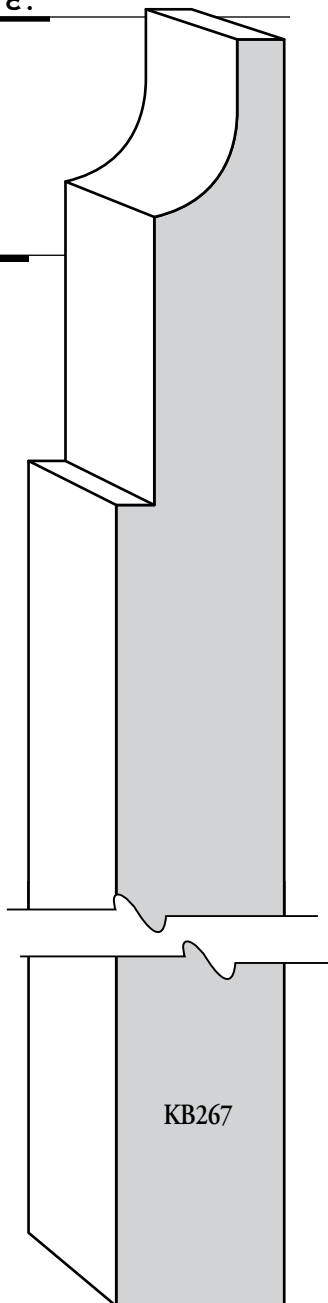

● Clear Pine

○ Primed FJ Pine

▲ Primed FJ Poplar

☛ Lightweight Primed MDF

KUIKEN BROTHERS
MODERN CRAFTSMAN
 MOULDING COLLECTION

Base Mouldings

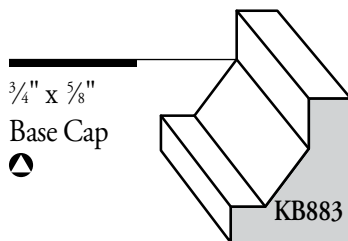
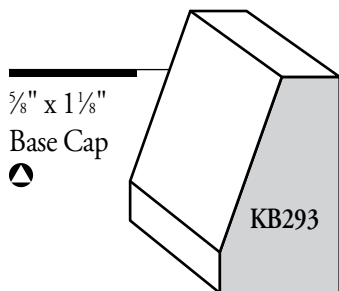
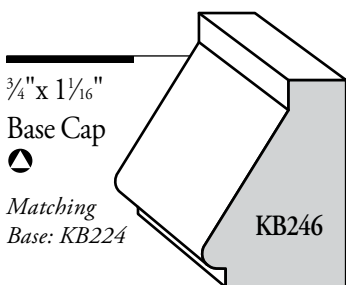
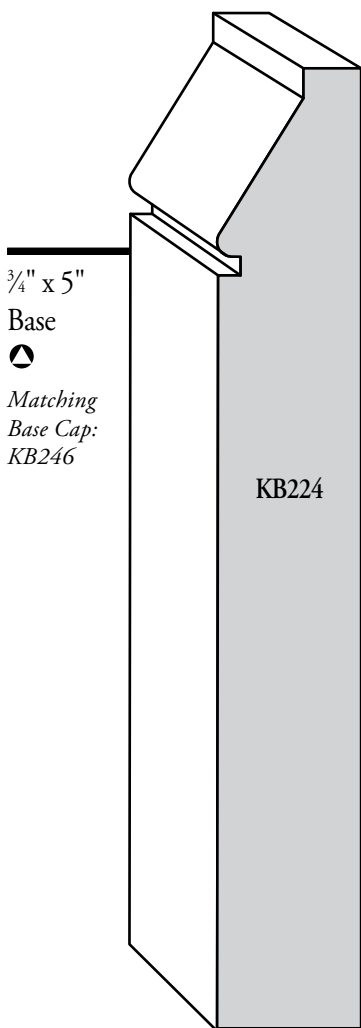

● Clear Pine

○ Primed FJ Pine

▲ Primed FJ Poplar

🍃 Lightweight Primed MDF



Base Cap Mouldings

1 1/16" x 2 3/16"

Base Cap



Matching

Base: KB231

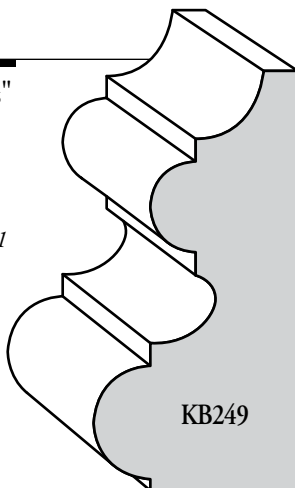

KB249

3/4" x 1 3/4"

Base Cap

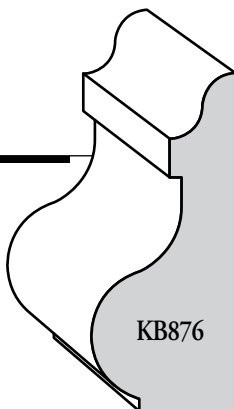

KB876

3/4" x 1 1/16"

Base Cap



Matching

Base: KB227

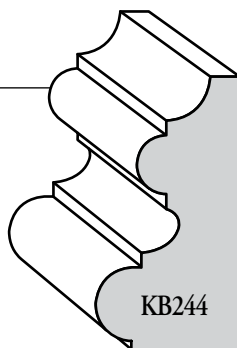

KB244

● Clear Pine

○ Primed FJ Pine

▲ Primed FJ Poplar

■ Lightweight Primed MDF



Base Cap Mouldings

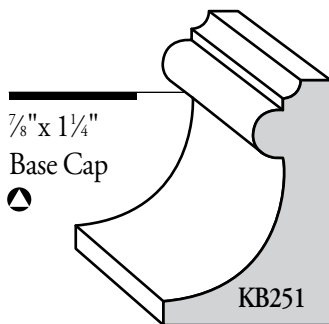
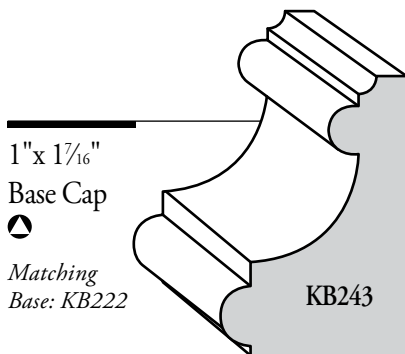
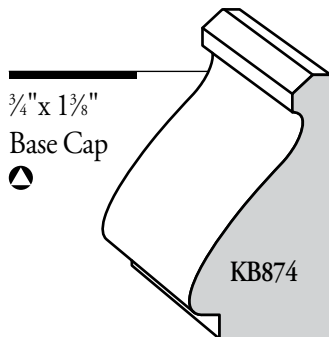

● Clear Pine

○ Primed FJ Pine

▲ Primed FJ Poplar

☙ Lightweight Primed MDF



Base Cap Mouldings

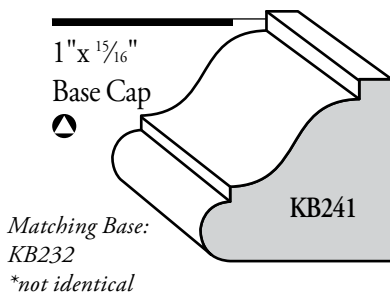
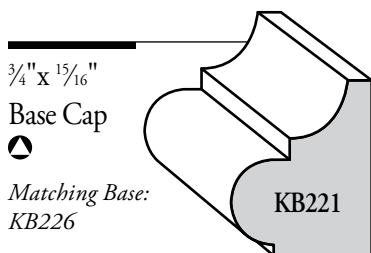
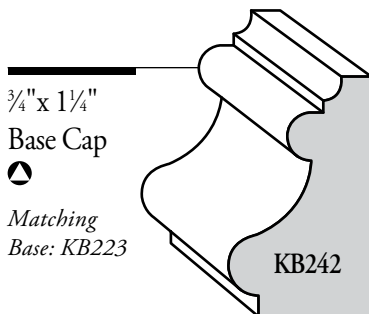

Base Cap Mouldings

$1\frac{1}{16}$ " x $1\frac{1}{8}$ "

Base Cap Moulding

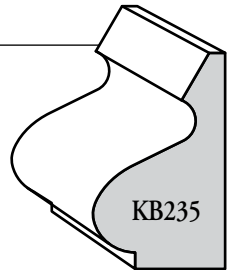

$1\frac{1}{16}$ " x $1\frac{3}{8}$ "

Base Cap Moulding

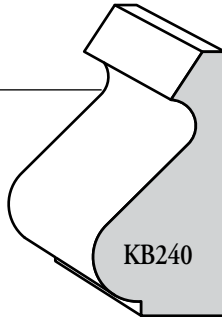

$\frac{5}{8}$ " x $1\frac{5}{8}$ "

Base Cap Moulding

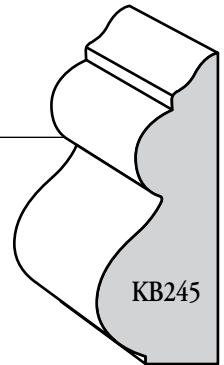

$\frac{9}{16}$ " x $1\frac{5}{8}$ "

Band Base Moulding

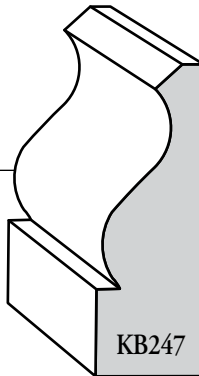

$\frac{3}{4}$ " x $1\frac{3}{4}$ "

Base Cap

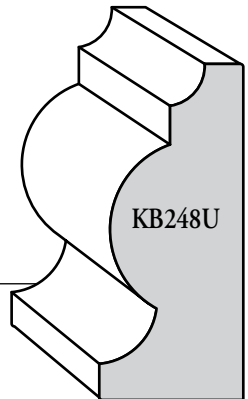

● Clear Pine

○ Primed FJ Pine

◐ Primed FJ Poplar

🍃 Lightweight Primed MDF

Base Mouldings

$\frac{1}{16}$ " x $2\frac{1}{2}$ "

Colonial Base
(Garage
Door Stop)

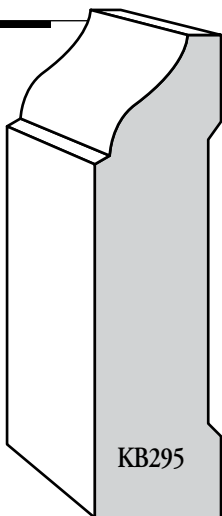

KB295

$\frac{1}{16}$ " x $3\frac{1}{2}$ "

Colonial
Casing/Base

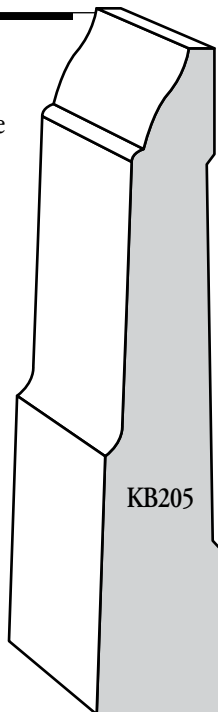

KB205

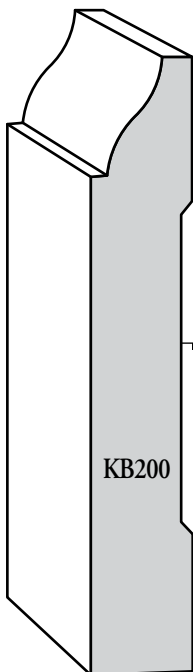

KB200

$\frac{3}{16}$ " x $3\frac{1}{4}$ "

Colonial
Base

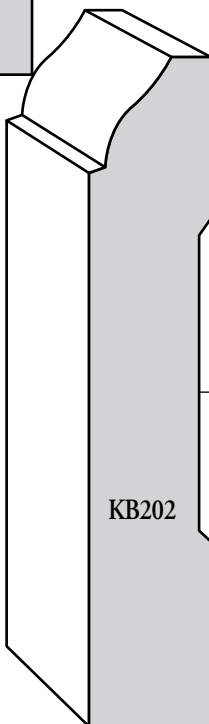

KB202

$\frac{1}{16}$ " x $3\frac{1}{2}$ "

Colonial Base



● Clear Pine

○ Primed FJ Pine

▲ Primed FJ Poplar

☛ Lightweight Primed MDF

Base Mouldings

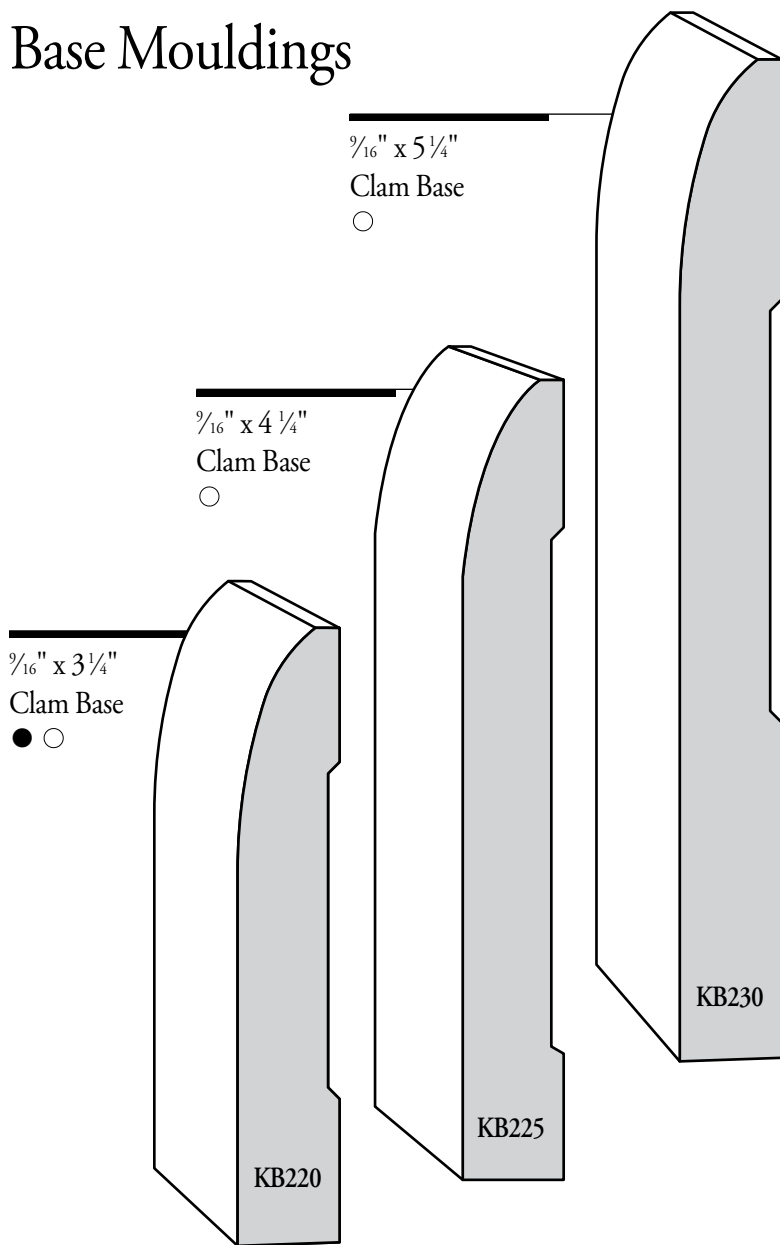

Base Mouldings

$\frac{1}{16}$ " x $6\frac{1}{2}$ "
Special Base



$\frac{9}{16}$ " x $5\frac{1}{8}$ "
Speed Base

**KB210 Primed Pine 5-1/4" tall*

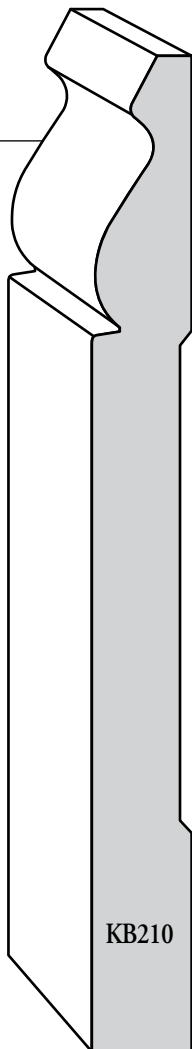

KB210

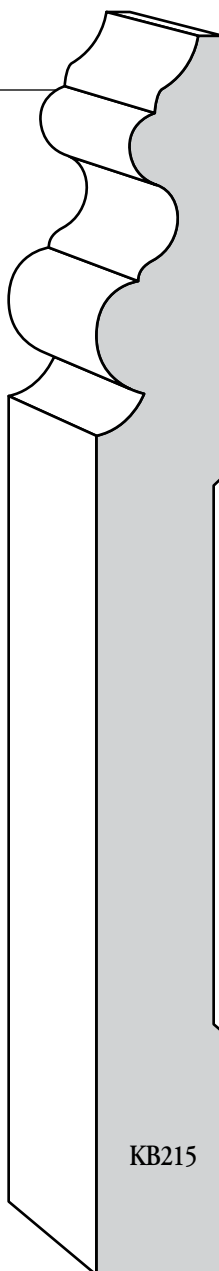

KB215

● Clear Pine

○ Primed FJ Pine

▲ Primed FJ Poplar

 Lightweight Primed MDF

Base & Floor Mouldings

$\frac{7}{8}$ " x $7\frac{1}{2}$ "
Special Base



$\frac{11}{16}$ " x $4\frac{7}{8}$ "
Special Base

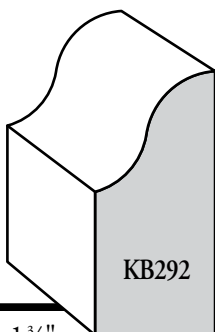

$\frac{5}{8}$ " x $1\frac{3}{8}$ "

Floor Moulding

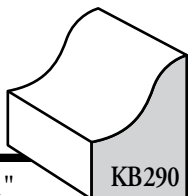

$\frac{1}{2}$ " x $\frac{3}{4}$ "

Floor Moulding

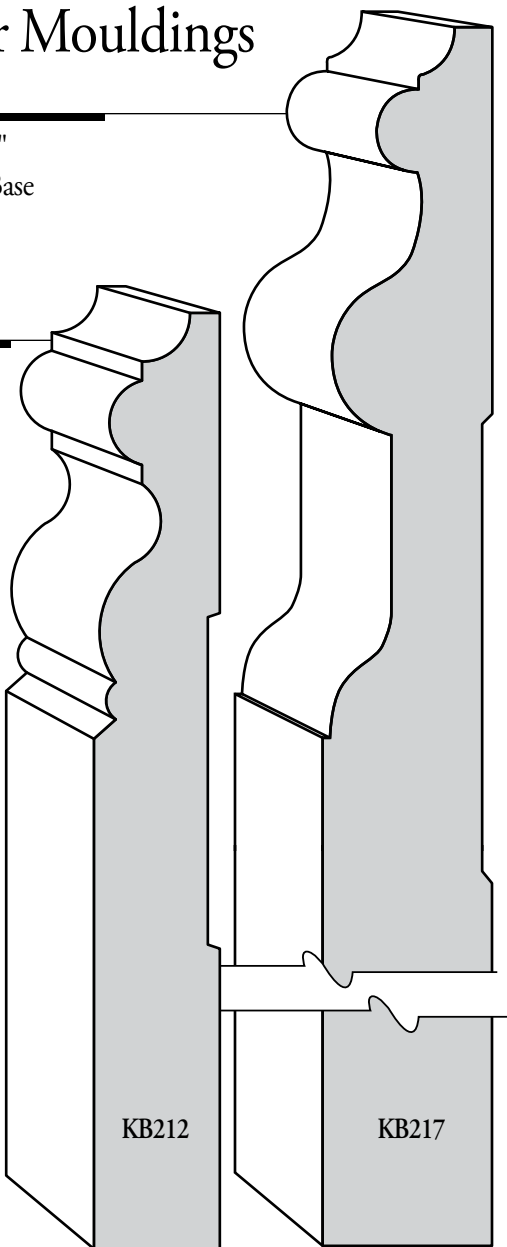

● Clear Pine

○ Primed FJ Pine

● Primed FJ Poplar

 Lightweight Primed MDF

Base Mouldings



KB227 Base 3/4" x 7-1/2"



KB232 Base 1-1/4" x 5-1/2"

Base Moulding Combinations

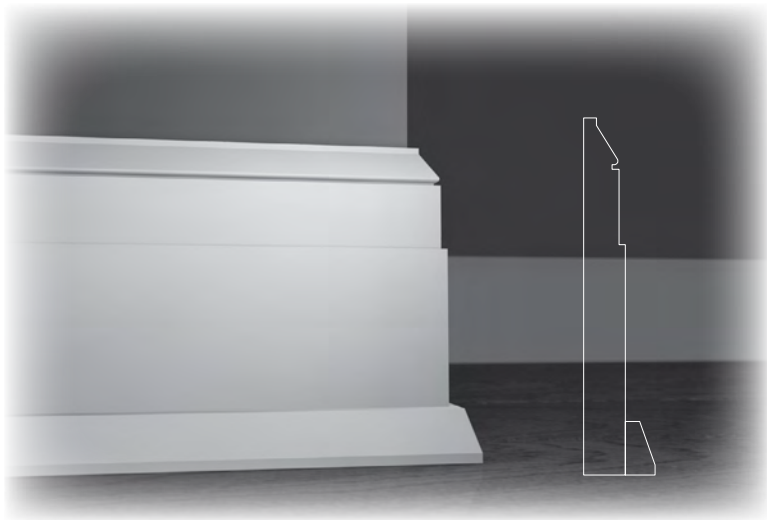

KB228 7/8" x 7-1/2" Base & KB293 5/8" x 1-1/8" Shoe

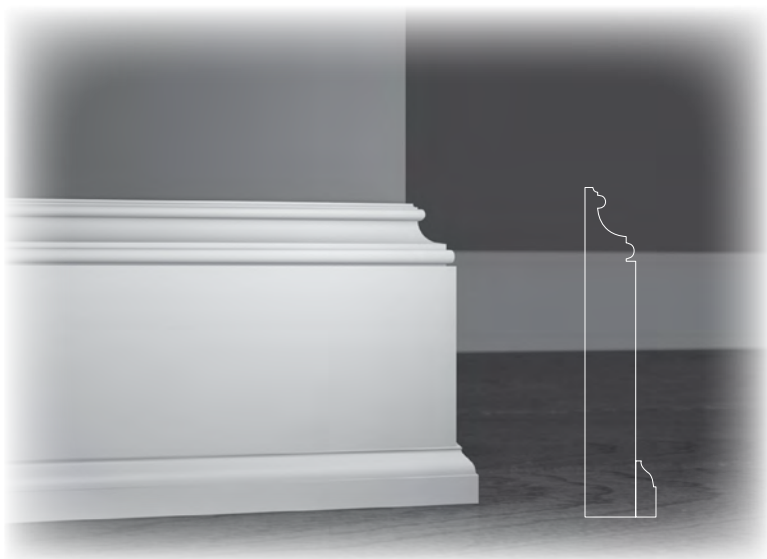

KB222 1" x 6-1/2" Base & KB635 3/8" x 1-1/8" Colonial Shoe



Crown Mouldings

1" x 7 1/4"
Crown



KB354

4 1/8"
6"

KB314

2"
3"

3/4" x 3 1/2"
Crown



● Clear Pine

○ Primed FJ Pine

△ Primed FJ Poplar

🌿 Lightweight Primed MDF



Crown Mouldings

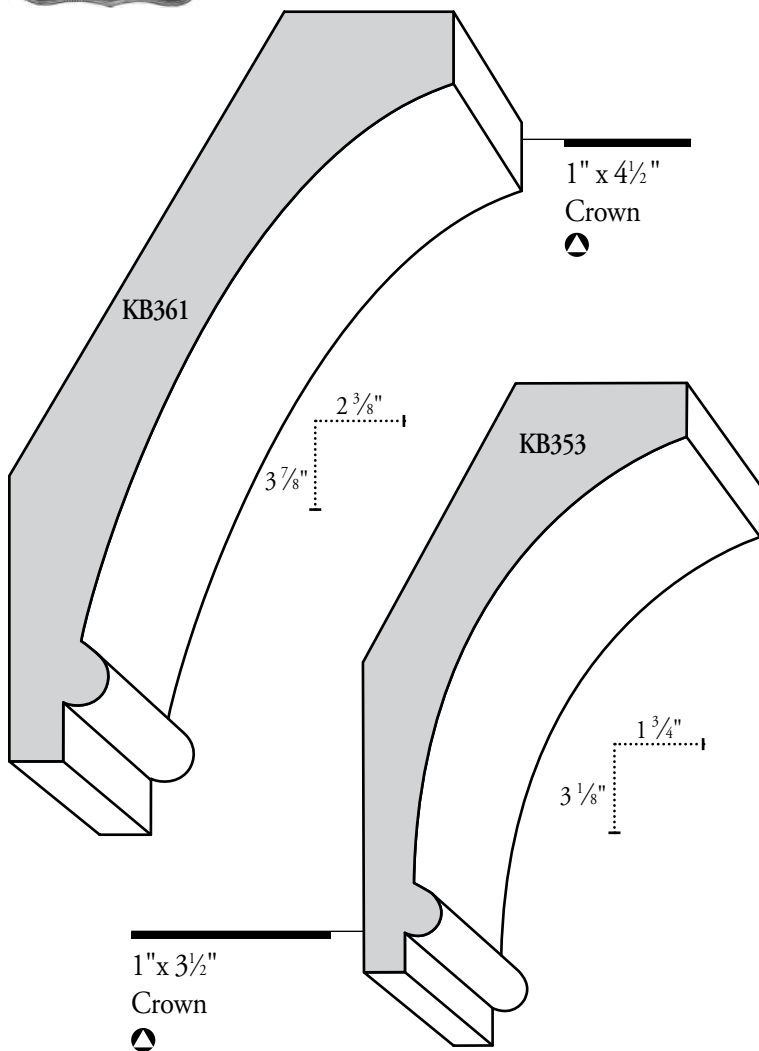

● Clear Pine

○ Primed FJ Pine

▲ Primed FJ Poplar

✎ Lightweight Primed MDF



Crown Mouldings

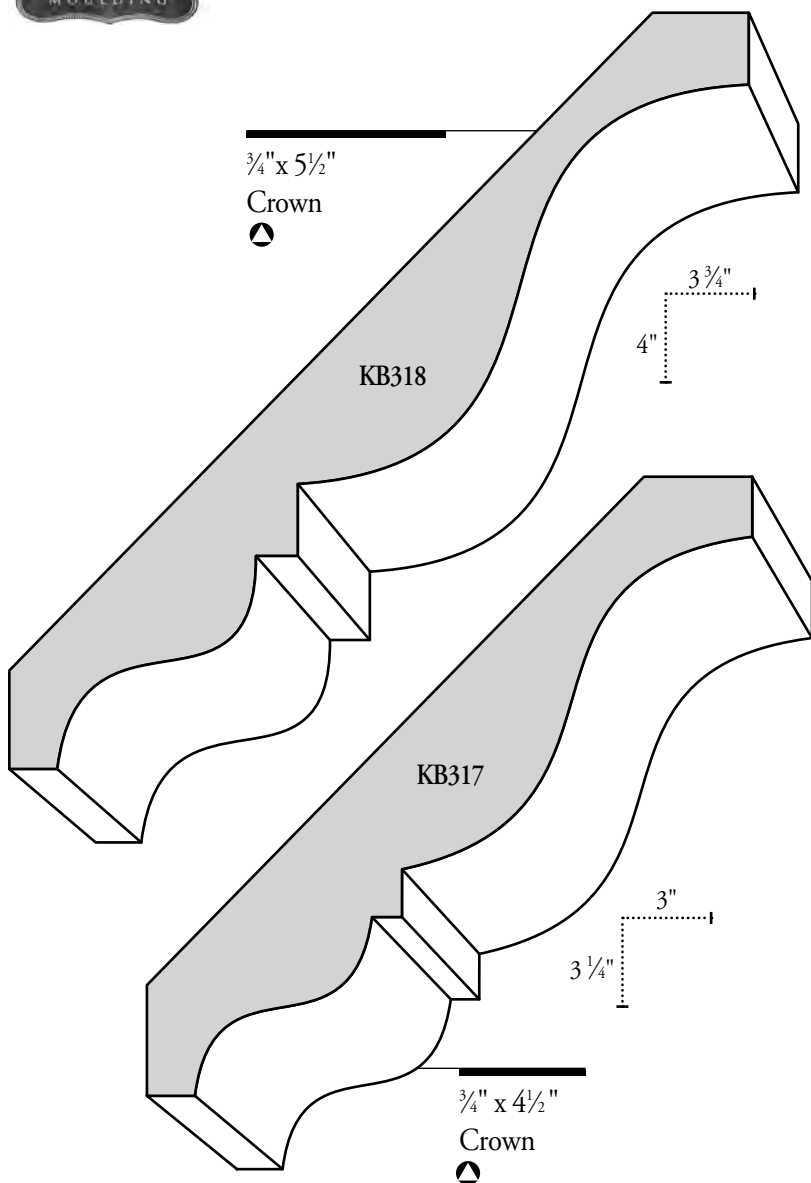

- Clear Pine
- Primed FJ Pine
- ▲ Primed FJ Poplar
- Lightweight Primed MDF



Crown Mouldings

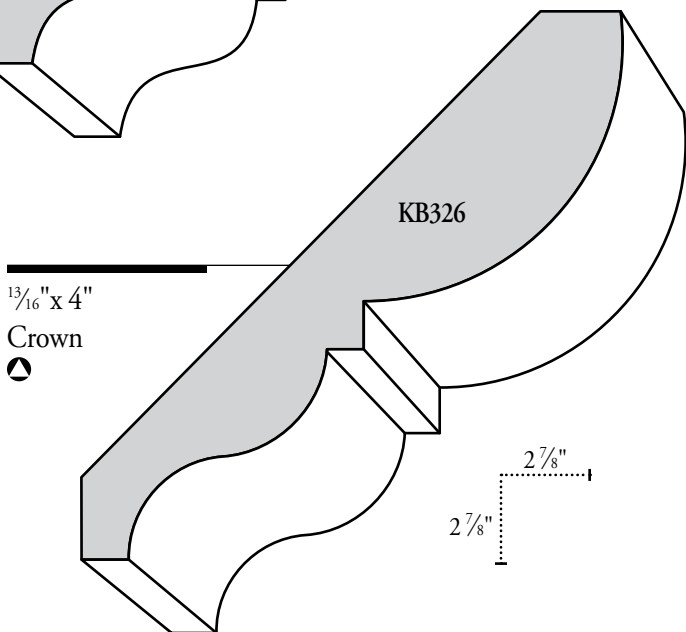
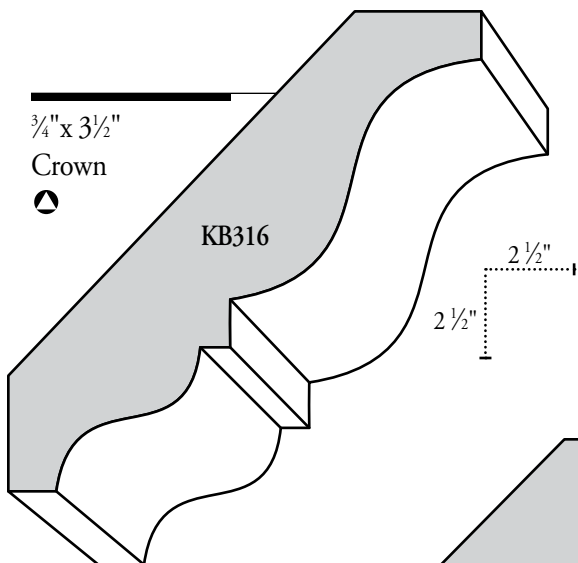

● Clear Pine

○ Primed FJ Pine

▲ Primed FJ Poplar

🍃 Lightweight Primed MDF



Crown Mouldings

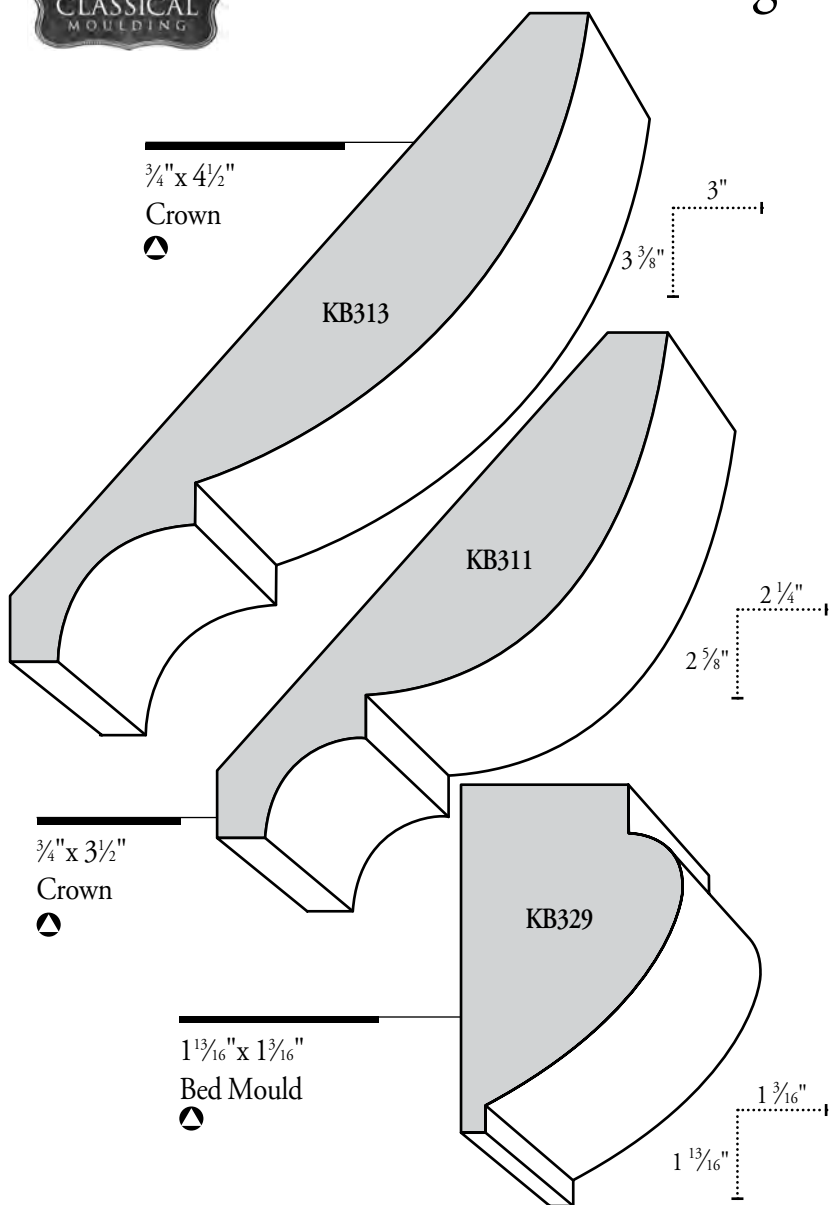

- Clear Pine
- Primed FJ Pine
- ▲ Primed FJ Poplar
- Lightweight Primed MDF



Crown Mouldings

$\frac{3}{4}$ " x $1\frac{1}{16}$ "
Bed Mould
▲

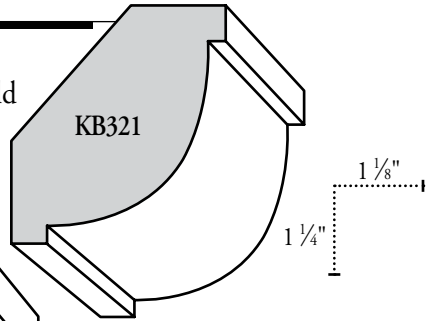

$\frac{3}{4}$ " x 2"
Terminating
Crown
▲

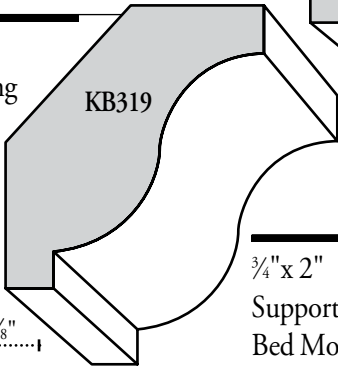

$\frac{3}{4}$ " x 2"
Supporting
Bed Mould
▲

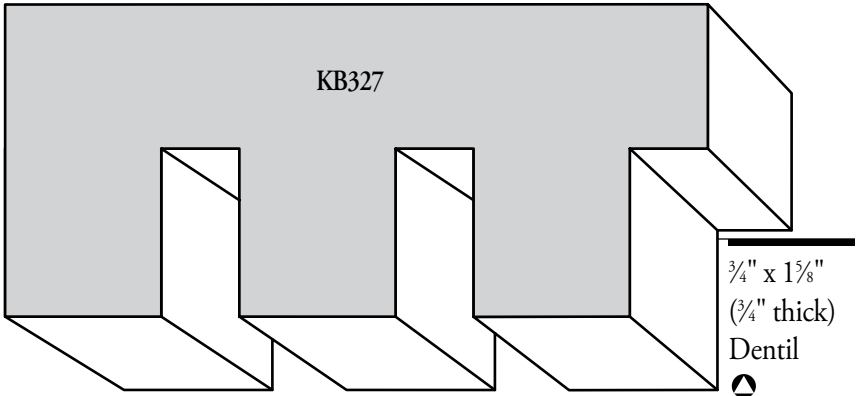
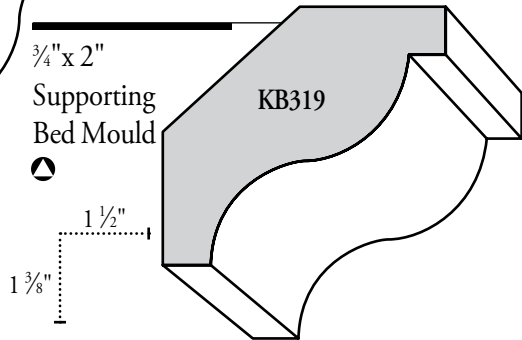

● Clear Pine

○ Primed FJ Pine

▲ Primed FJ Poplar

🍃 Lightweight Primed MDF



Crown Mouldings

$\frac{3}{4}$ " x $7\frac{1}{4}$ "

Fascia



$\frac{3}{4}$ " x 3"

Bed Mould



KB324

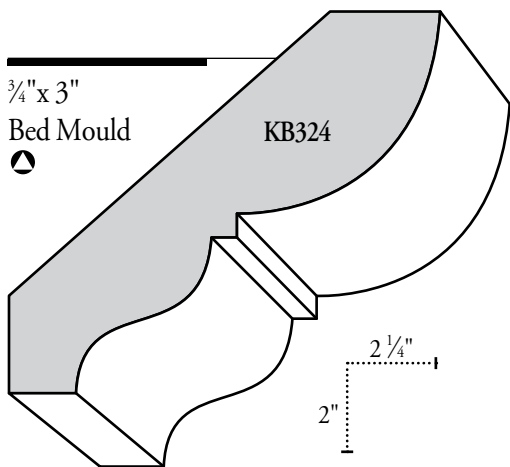

$2\frac{1}{4}$ "

2"

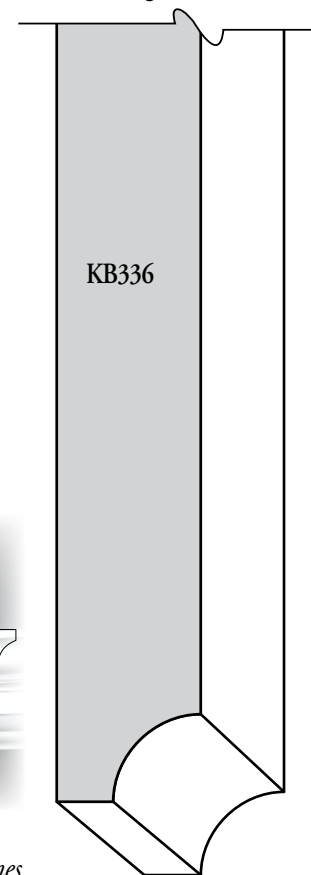
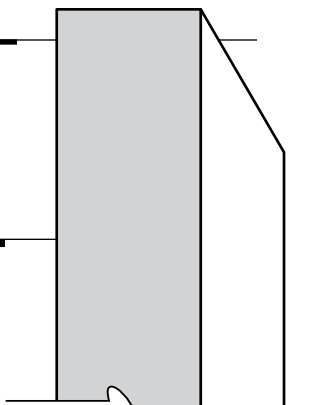
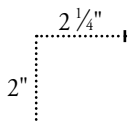

KB336

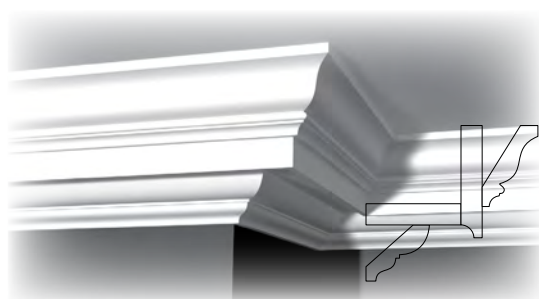

Use the KB336 Fascia in crown combination applications to create depth and stronger shadow lines.

● Clear Pine

○ Primed FJ Pine

● Primed FJ Poplar

● Lightweight Primed MDF

**profiles not to scale*

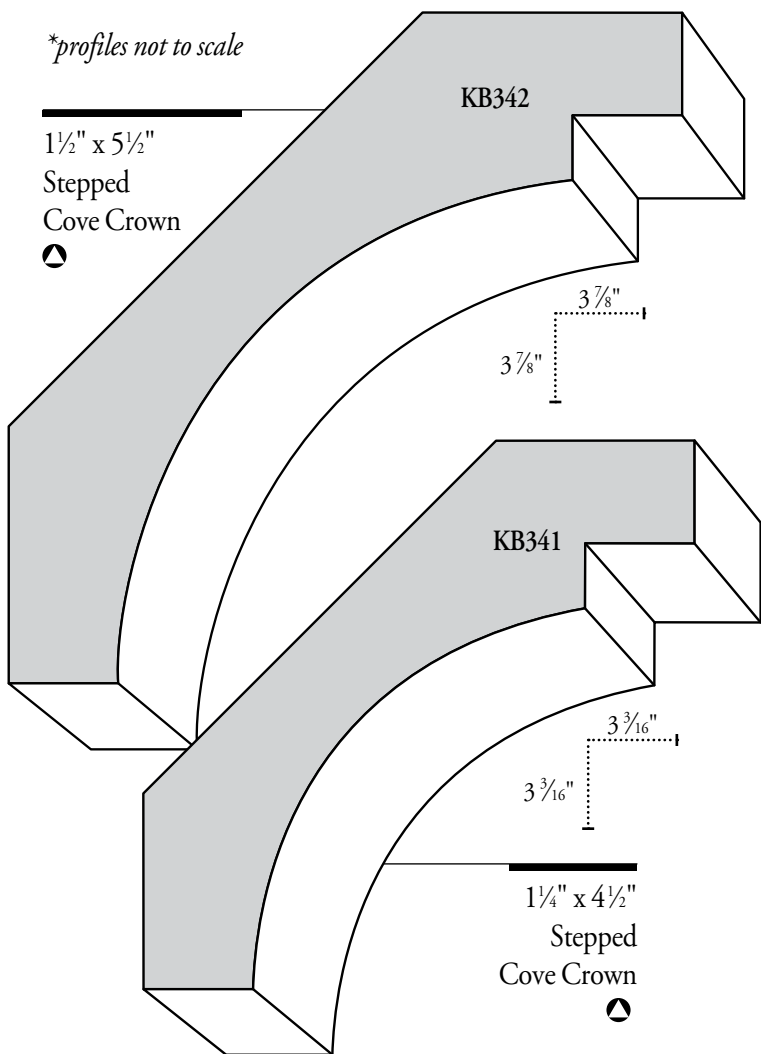

1 1/2" x 5 1/2"
Stepped
Cove Crown
●

KB342

3 7/8"
3 7/8"

KB341

3 3/16"
3 3/16"

1 1/4" x 4 1/2"
Stepped
Cove Crown
●

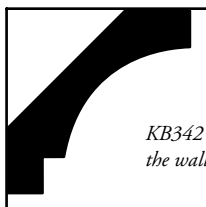

KB342 and KB341 can be installed with the step applied to the wall as well.

KUIKEN BROTHERS
MODERN CRAFTSMAN
MOULDING COLLECTION

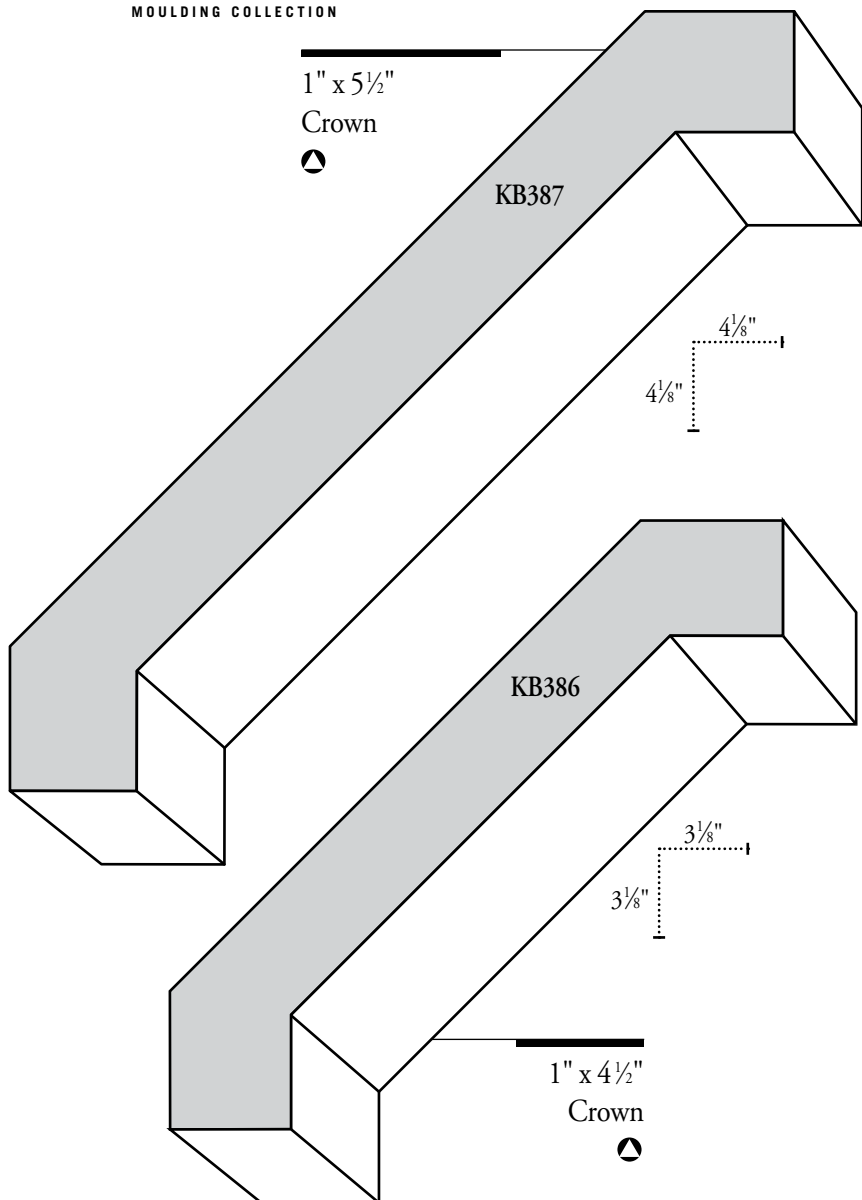

● Clear Pine

○ Primed FJ Pine

▲ Primed FJ Poplar

■ Lightweight Primed MDF

KUIKEN BROTHERS
MODERN CRAFTSMAN
MOULDING COLLECTION

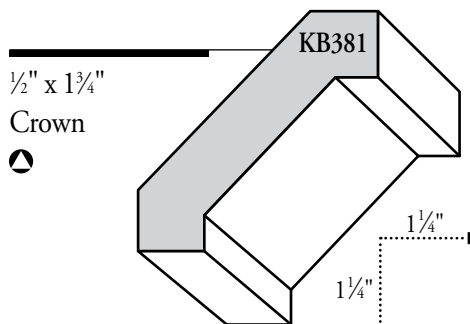
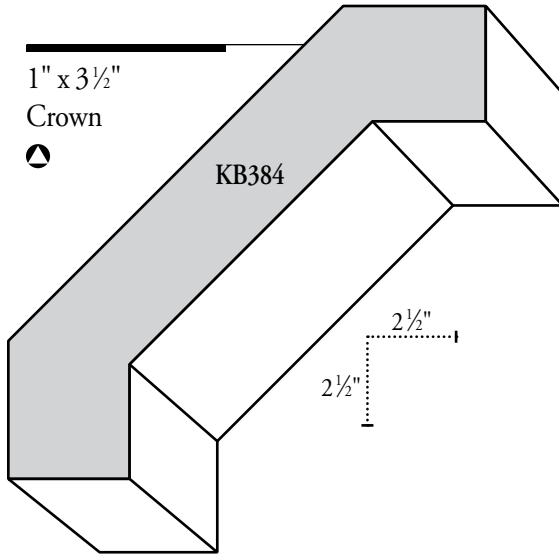

● Clear Pine

○ Primed FJ Pine

● Primed FJ Poplar

● Lightweight Primed MDF

KUIKEN BROTHERS
MODERN CRAFTSMAN
 MOULDING COLLECTION

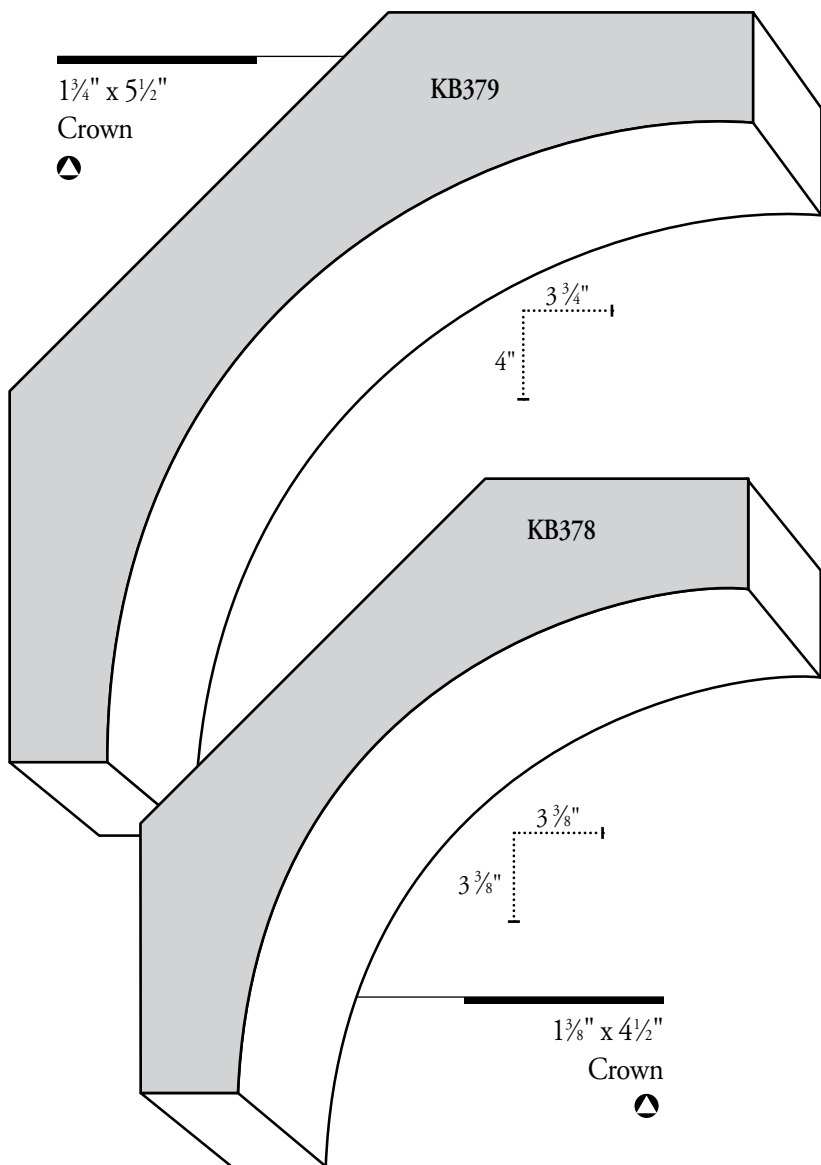

● Clear Pine

○ Primed FJ Pine

▲ Primed FJ Poplar

■ Lightweight Primed MDF

Crown Mouldings

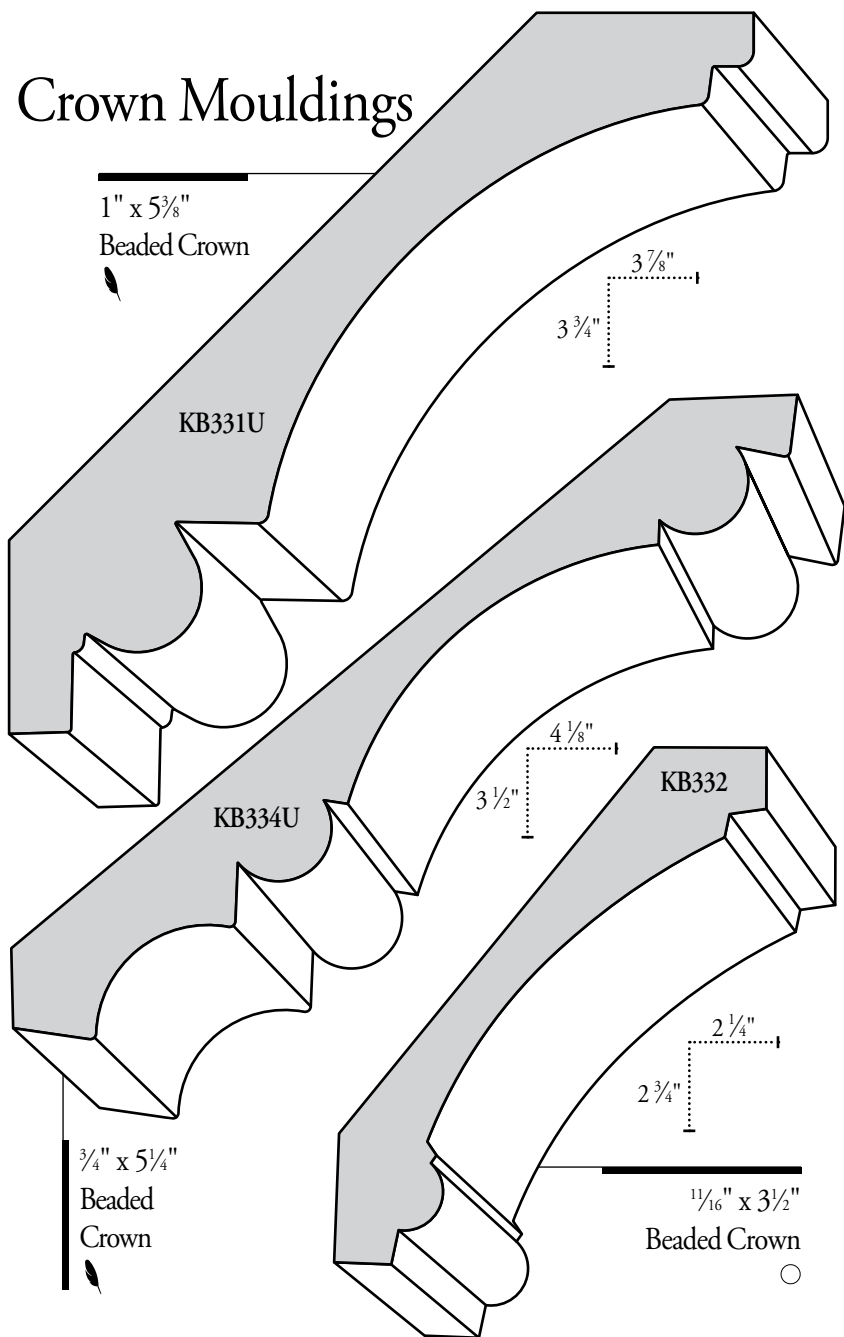

● Clear Pine

○ Primed FJ Pine

▲ Primed FJ Poplar

♻️ Lightweight Primed MDF

Crown Mouldings

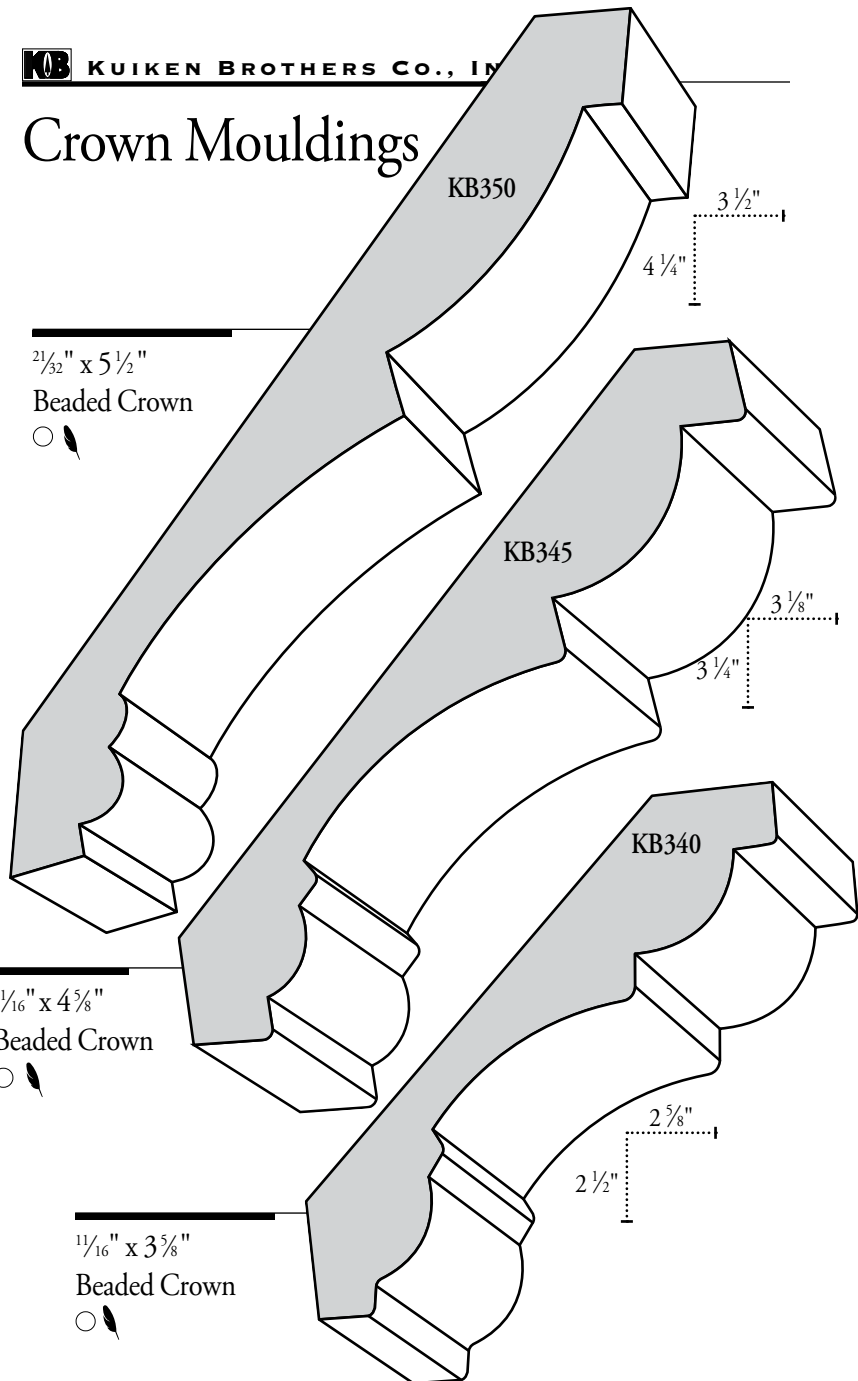

● Clear Pine

○ Primed FJ Pine

▲ Primed FJ Poplar

♣ Lightweight Primed MDF

Crown & Bed Mouldings

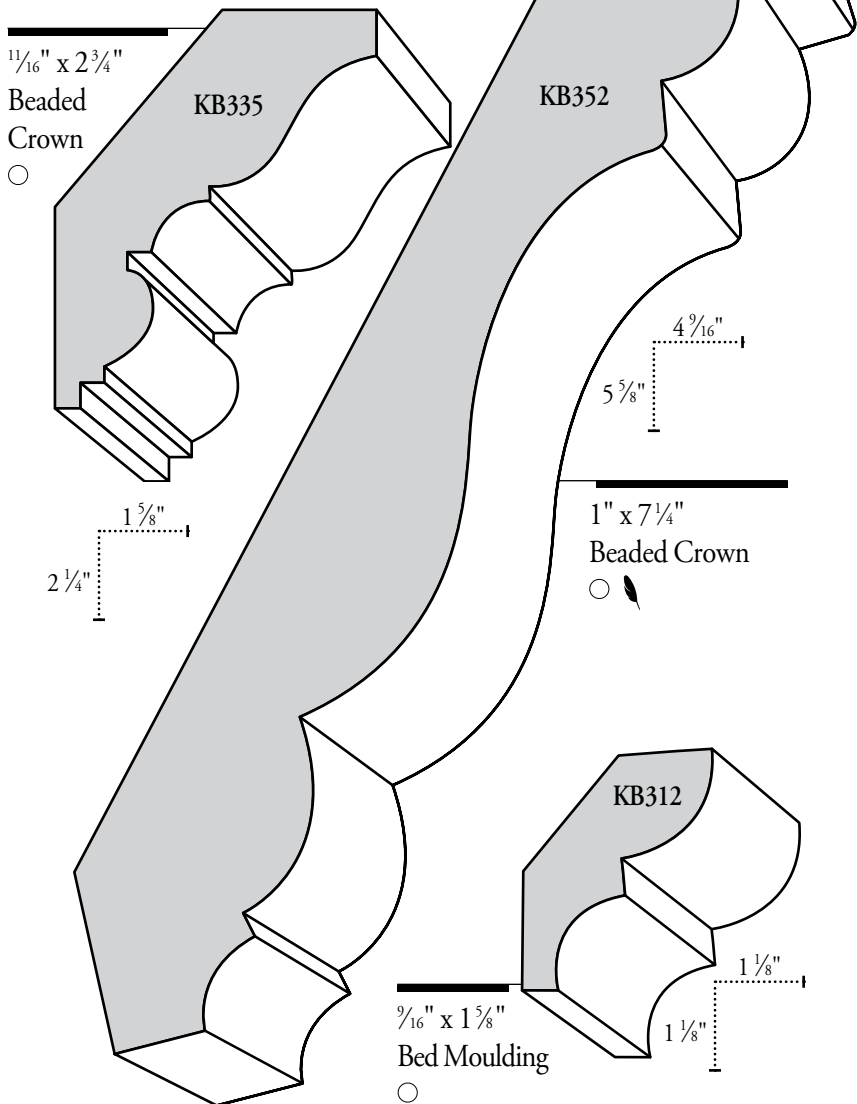

Crown Mouldings

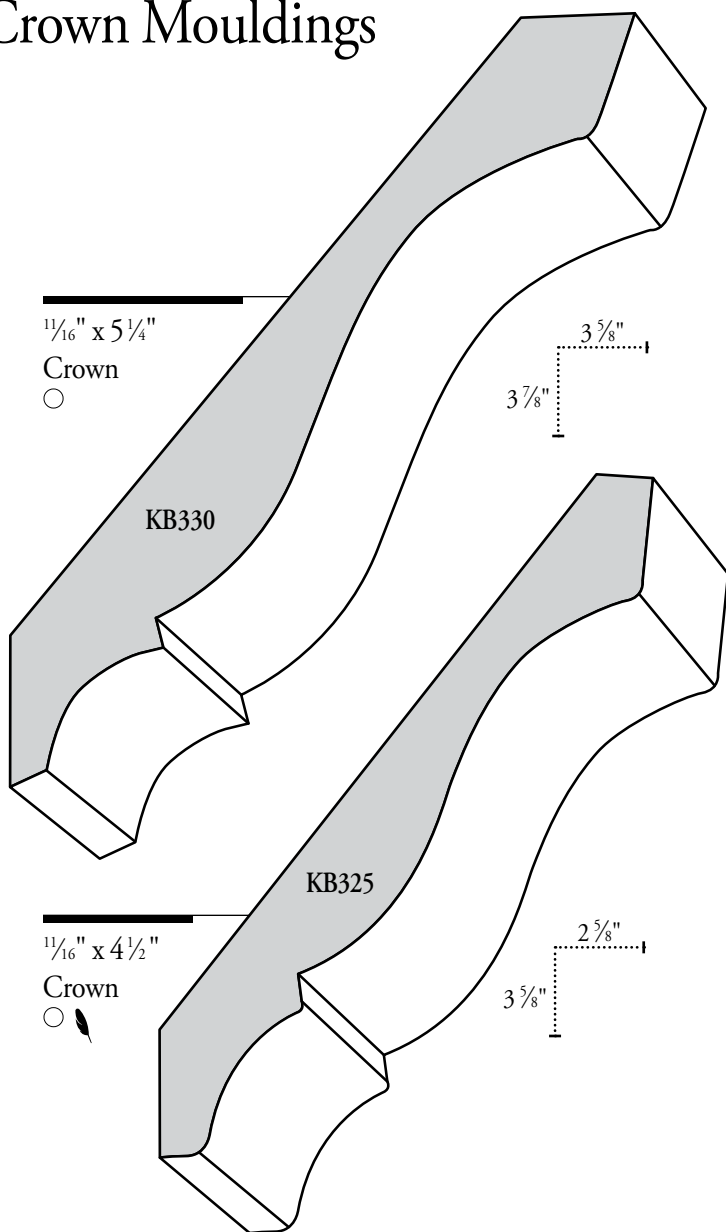

● Clear Pine

○ Primed FJ Pine

▲ Primed FJ Poplar

♣ Lightweight Primed MDF

Crown Mouldings

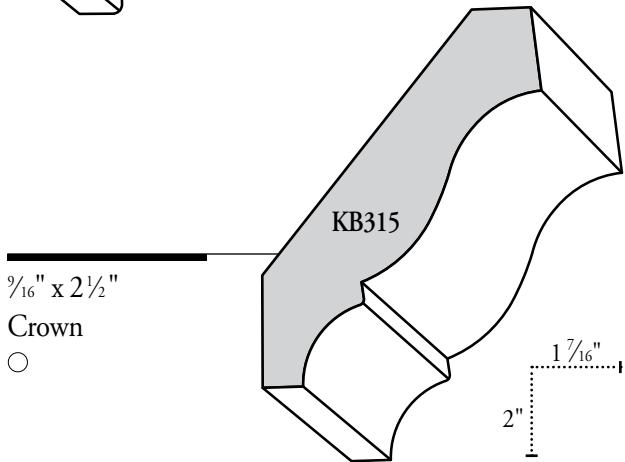
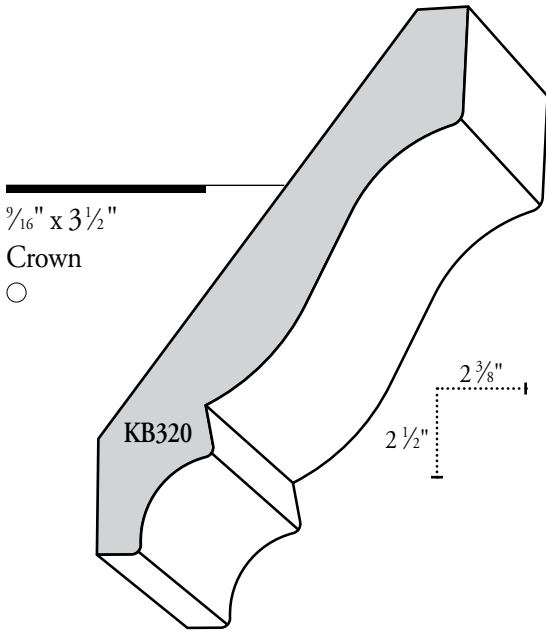

● Clear Pine

○ Primed FJ Pine

▲ Primed FJ Poplar

☛ Lightweight Primed MDF

Crown Mouldings

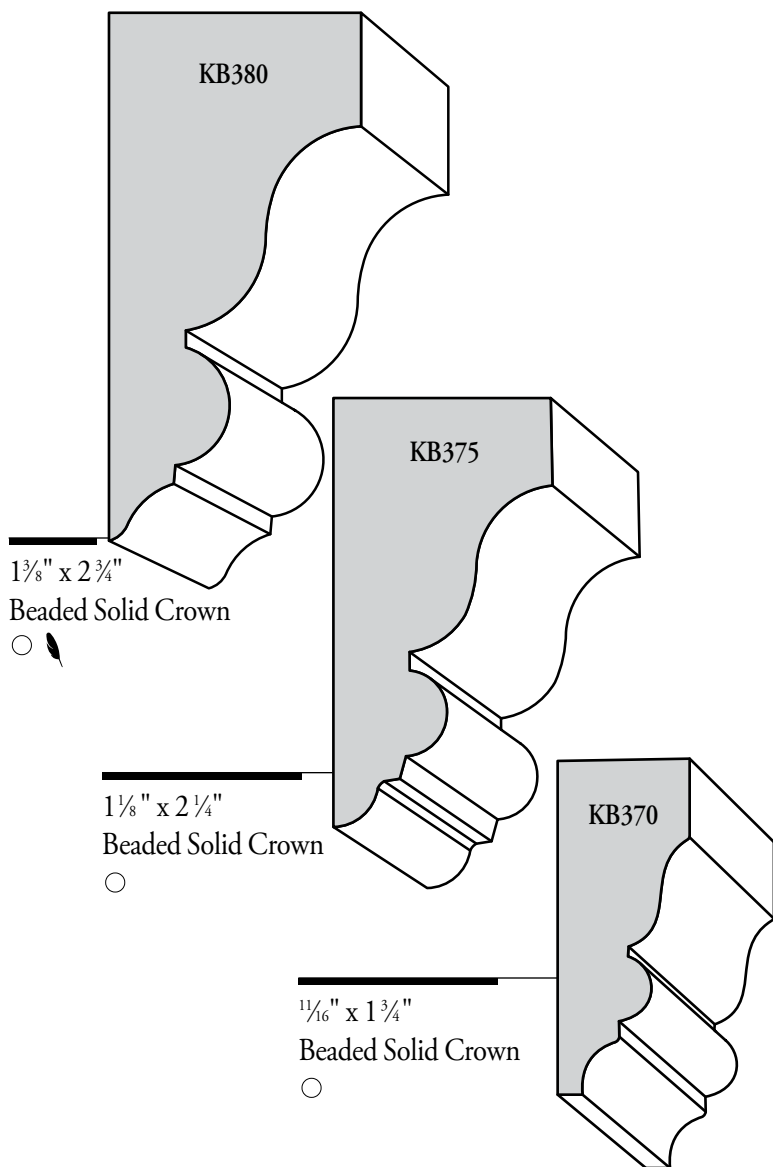

● Clear Pine

○ Primed FJ Pine

▲ Primed FJ Poplar

● Lightweight Primed MDF

Crown Mouldings

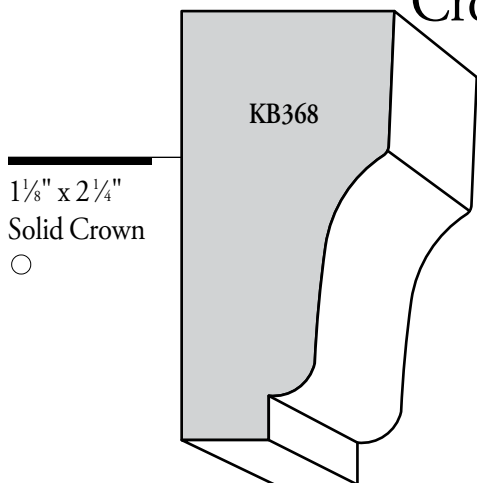

1 1/8" x 2 1/4"
Solid Crown

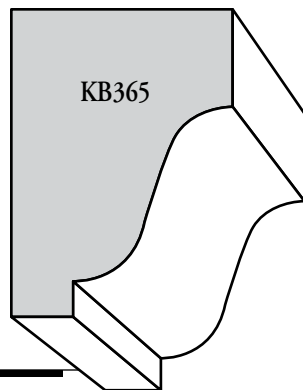

1 1/8" x 1 5/8"
Solid Crown

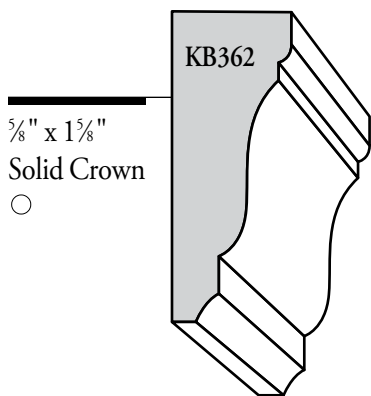

5/8" x 1 5/8"
Solid Crown

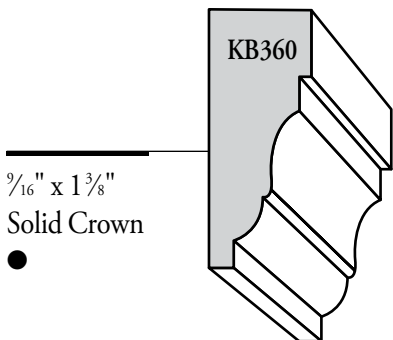

9/16" x 1 3/8"
Solid Crown

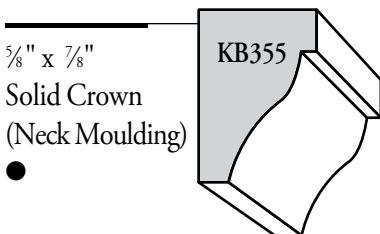

5/8" x 7/8"
Solid Crown
(Neck Moulding)



● Clear Pine

○ Primed FJ Pine

▲ Primed FJ Poplar

☛ Lightweight Primed MDF



Crown Combinations



Crown Combination featuring KB317, KB336, KB324

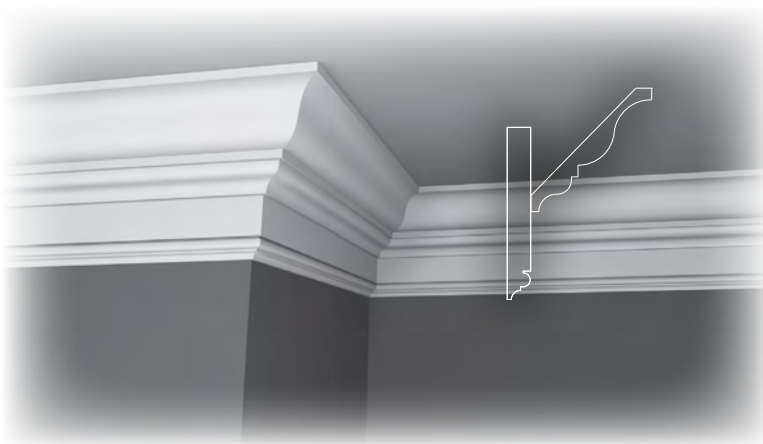

Crown Combination featuring KB318, KB226

● Clear Pine

○ Primed FJ Pine

▲ Primed FJ Poplar

☛ Lightweight Primed MDF



Crown Combinations

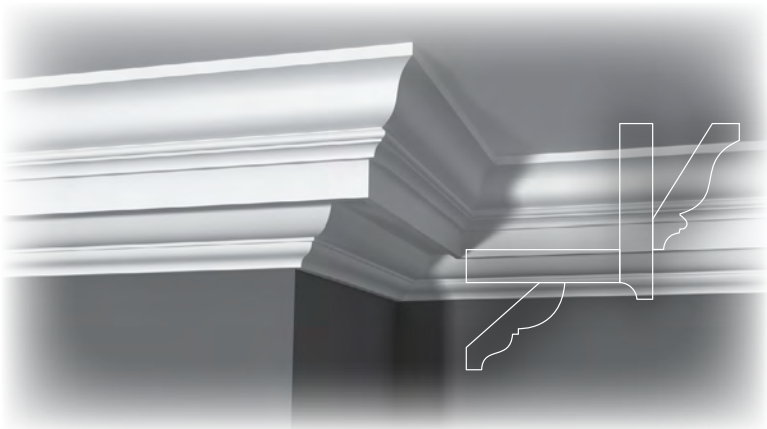

Crown Combination featuring KB314, KB336, KB324, 1x4S4S

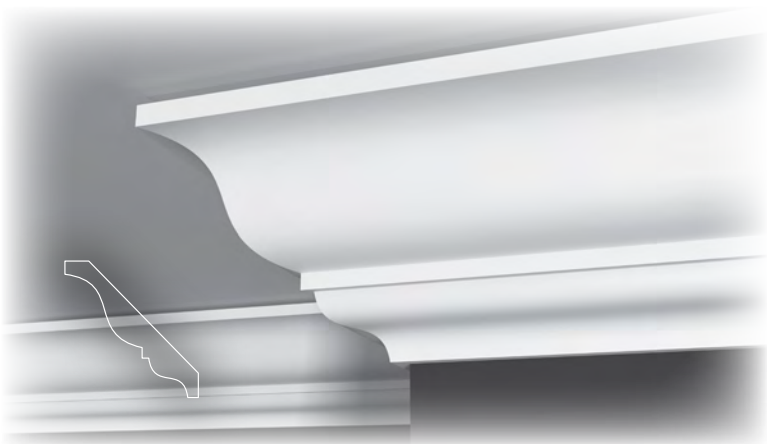

KB317 Crown (3/4" x 4-1/2")

● Clear Pine

○ Primed FJ Pine

▲ Primed FJ Poplar

✎ Lightweight Primed MDF



Crown Combinations

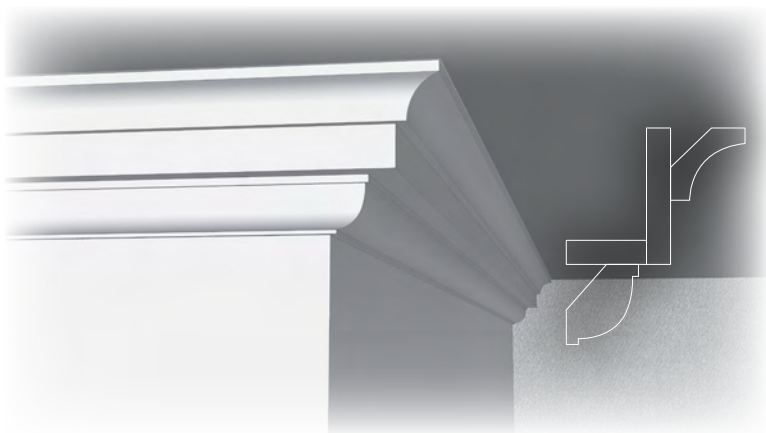

Early American Crown Combination featuring KB308, KB321 & Flat Stock Beam

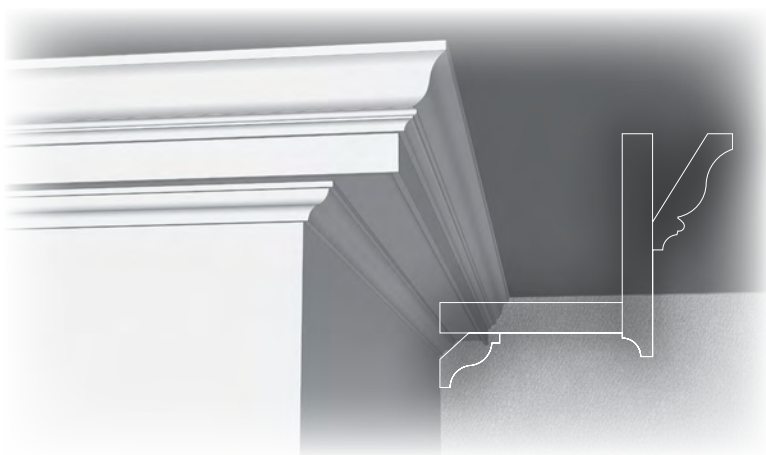

Federal Crown Combination featuring KB314, KB336, KB319 & Flat Stock Beam

● Clear Pine

○ Primed FJ Pine

▲ Primed FJ Poplar

✦ Lightweight Primed MDF



Crown Combinations

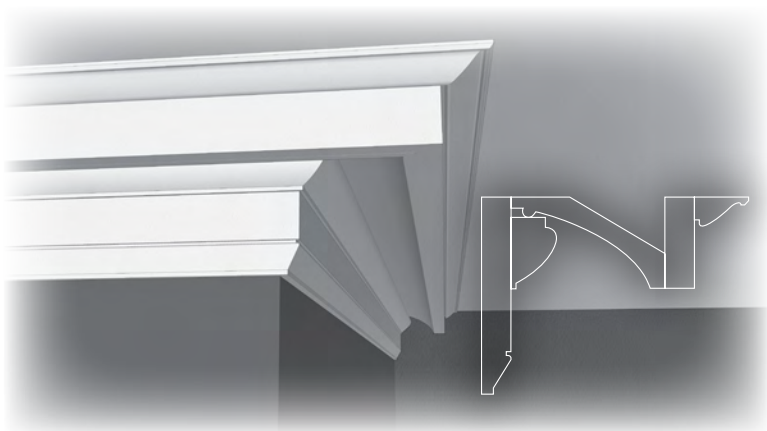

Greek Revival Crown Combination featuring KB874, KB361, KB329, KB224

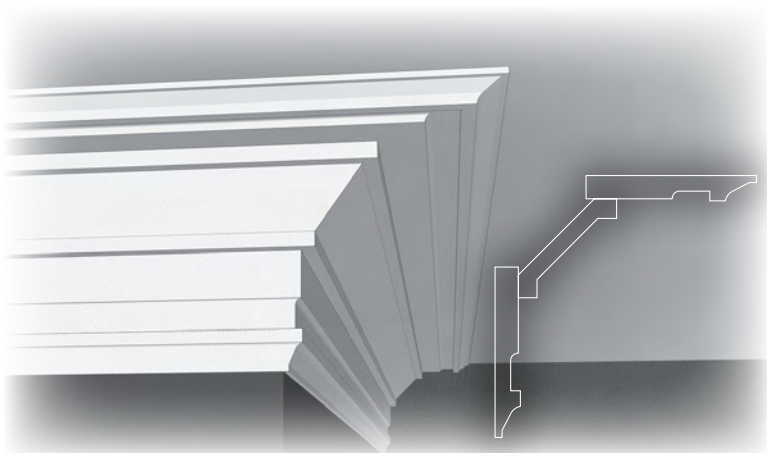

Modern Craftsman Crown Combination featuring KB386, KB233

● Clear Pine

○ Primed FJ Pine

▲ Primed FJ Poplar

✎ Lightweight Primed MDF

MOULDING DESIGN GUIDE

Go to kuikenbrothers.com/mouldingdesignguide to view our ever-expanding library of Crown and Coffered Ceiling combinations. View and download CAD files of detailed diagrams for your specifications.

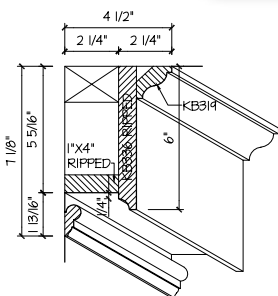
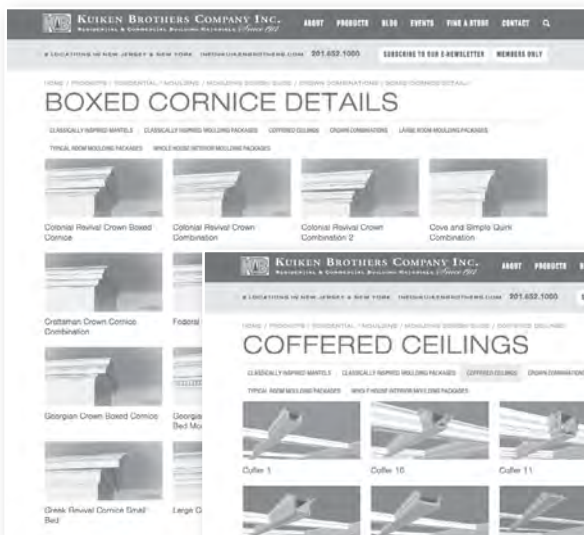

WALL BEAM

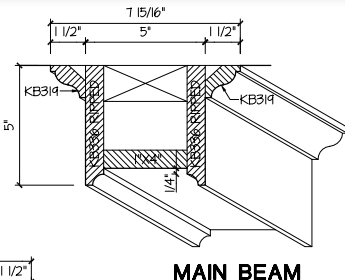

MAIN BEAM

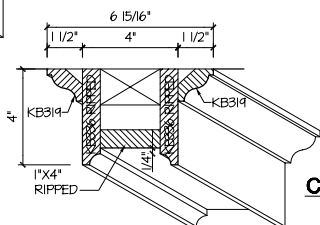

CROSS BEAM

SCALE: 3" = 1'-0"



Dentil Mouldings

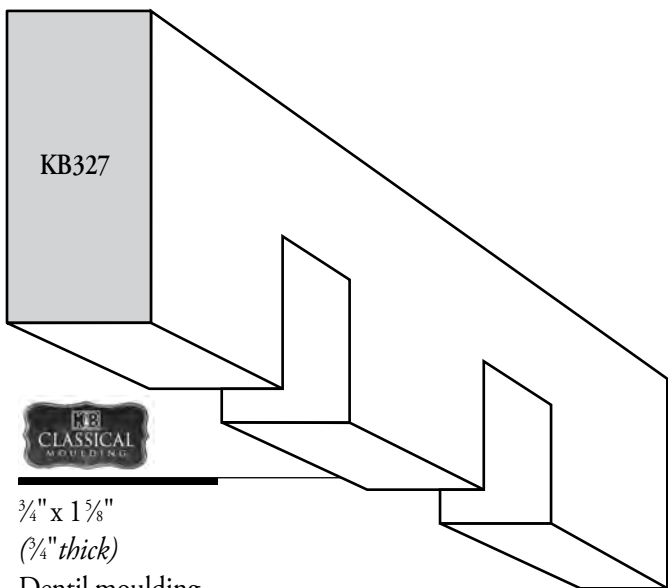

$\frac{3}{4}$ " x $1\frac{5}{8}$ "

($\frac{3}{4}$ " thick)

Dentil moulding



$\frac{3}{4}$ " x $1\frac{5}{8}$ "

Combination Dentil Moulding

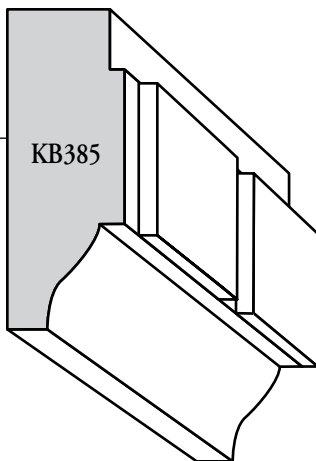

● Clear Pine

○ Primed FJ Pine

▲ Primed FJ Poplar

☙ Lightweight Primed MDF

Nose & Cove Mouldings

$\frac{3}{8}$ " x $\frac{1}{2}$ "
Nose & Cove

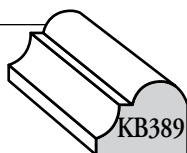

$\frac{5}{8}$ " x $\frac{3}{4}$ "
Nose & Cove

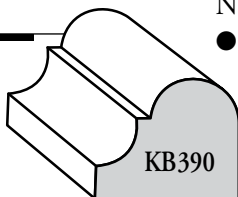

$\frac{3}{4}$ " x $\frac{15}{16}$ "
Classical Nose
& Cove

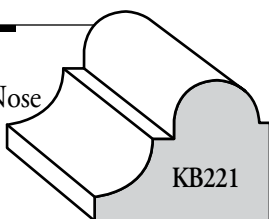

$1\frac{1}{16}$ " x $1\frac{1}{8}$ "
Nose & Cove

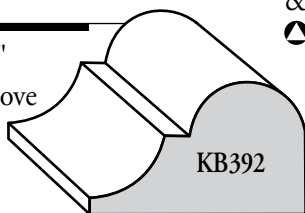

$\frac{3}{4}$ " x $1\frac{3}{8}$ "
Nose & Cove

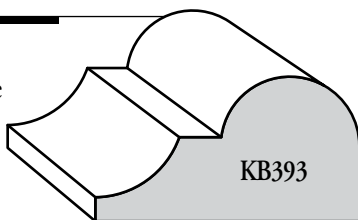

$1\frac{1}{8}$ " x $1\frac{1}{8}$ "
Nose & Cove

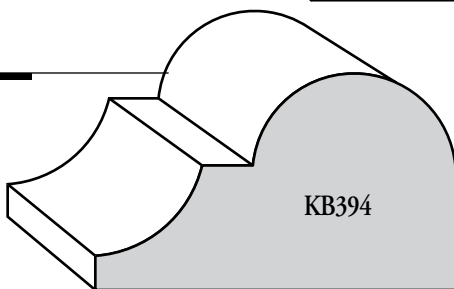

● Clear Pine

○ Primed FJ Pine

▲ Primed FJ Poplar

♣ Lightweight Primed MDF

Cove Mouldings

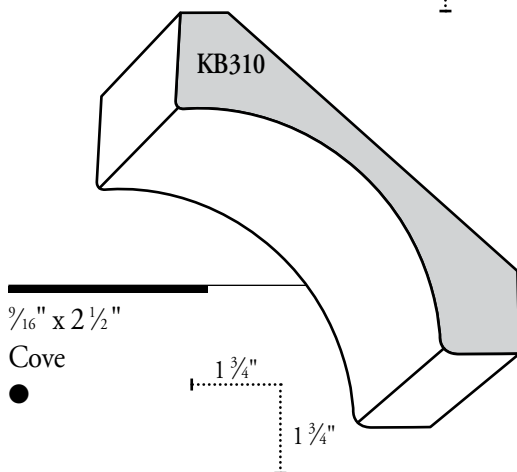
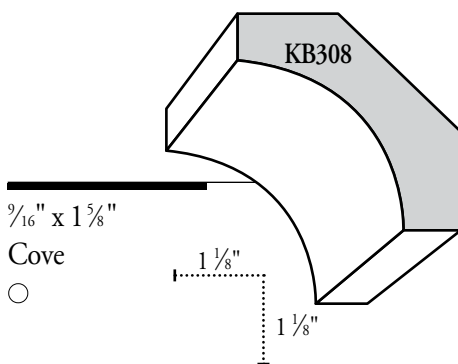
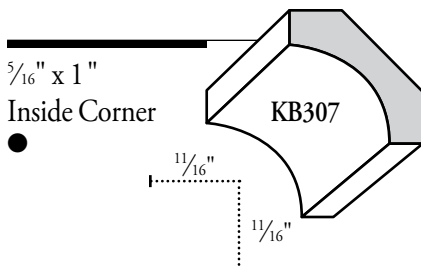

● Clear Pine

○ Primed FJ Pine

◐ Primed FJ Poplar

🍃 Lightweight Primed MDF



Cove Mouldings

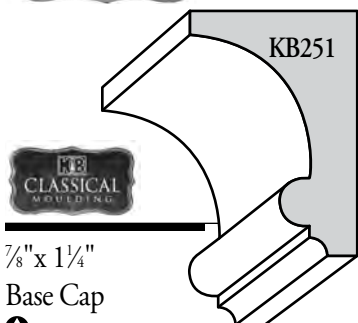

$\frac{7}{8}$ " x $1\frac{1}{4}$ "
Base Cap

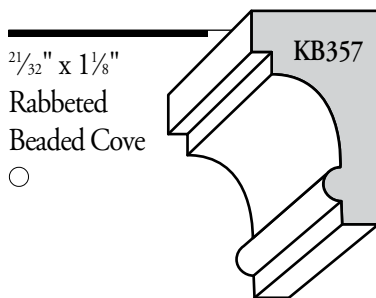

$2\frac{1}{32}$ " x $1\frac{1}{8}$ "
Rabbeted
Beaded Cove

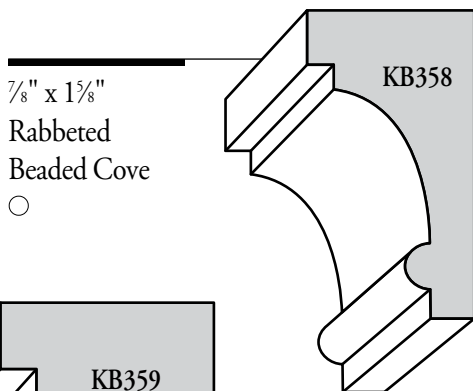

$\frac{7}{8}$ " x $1\frac{3}{8}$ "
Rabbeted
Beaded Cove

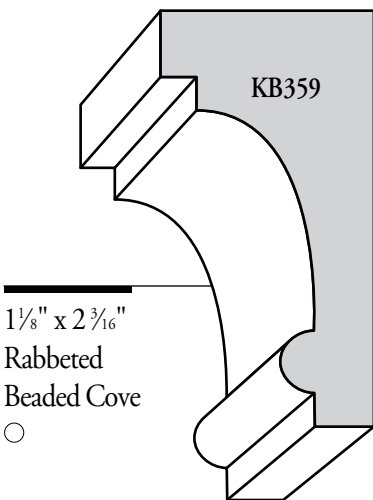

$1\frac{1}{8}$ " x $2\frac{3}{16}$ "
Rabbeted
Beaded Cove

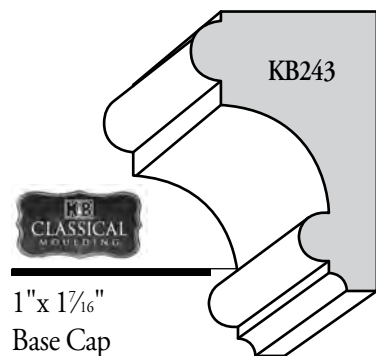

1" x $1\frac{1}{16}$ "
Base Cap



- Clear Pine
- Primed FJ Pine
- Primed FJ Poplar
- Lightweight Primed MDF

Cove Mouldings

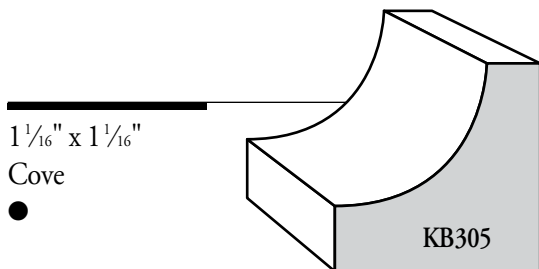
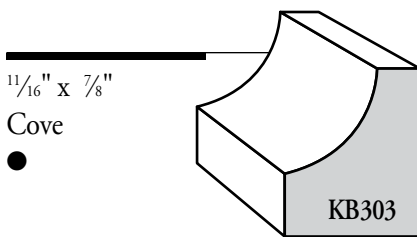
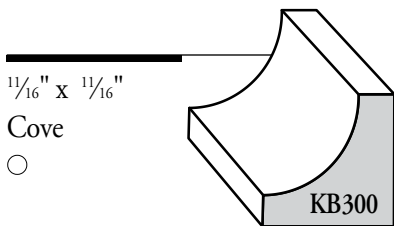

● Clear Pine

○ Primed FJ Pine

▲ Primed FJ Poplar

☙ Lightweight Primed MDF

Pilaster Mouldings

1 1/8" x 5 1/4"
 Fluted Pilaster
 ○ (8' only)

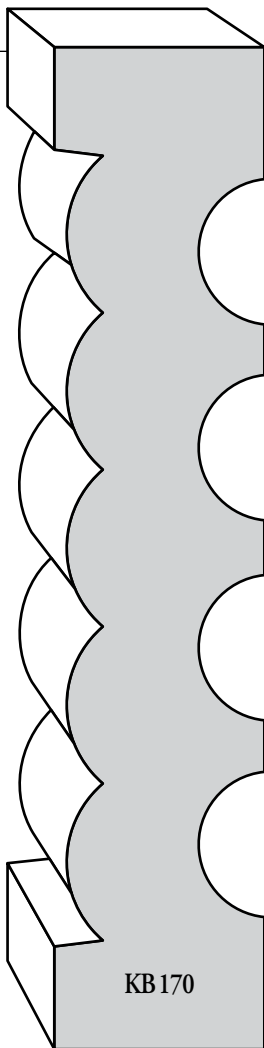

1 1/8" x 7 1/4"
 Fluted Pilaster
 ○ (8' only)

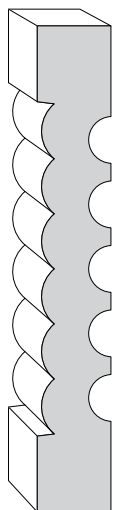
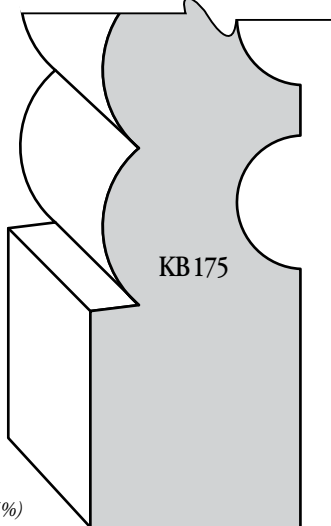
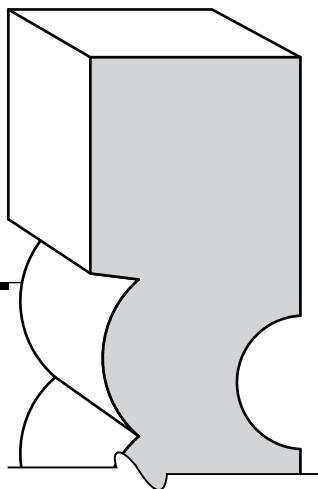

(Full KB175 shown at 35%)

- Clear Pine
- Primed FJ Pine
- ▲ Primed FJ Poplar
- ♣ Lightweight Primed MDF

Pilaster & Reeded Accent



$\frac{1}{2}$ " x $3\frac{1}{4}$ "
Reeded Accent
($\frac{3}{8}$ " Bead)

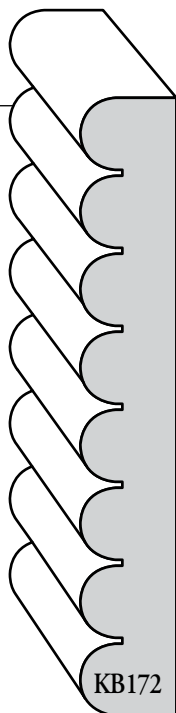

$\frac{1}{16}$ " x $3\frac{1}{4}$ "
Fluted/
Reeded Casing

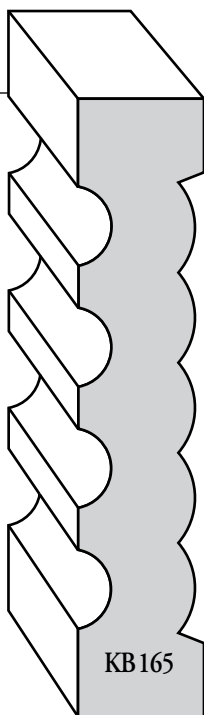

● Clear Pine

○ Primed FJ Pine

◐ Primed FJ Poplar

◑ Lightweight Primed MDF

Chair Rail



1 ¹³/₁₆" x 4 ¹/₈"

Chair Rail

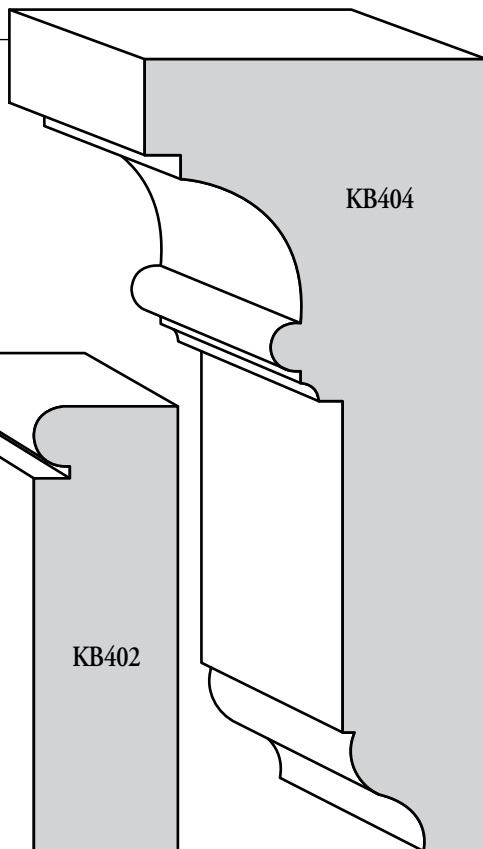

KB404

KB402

3 ¹/₄" x 3 ¹/₂"

Chair Rail

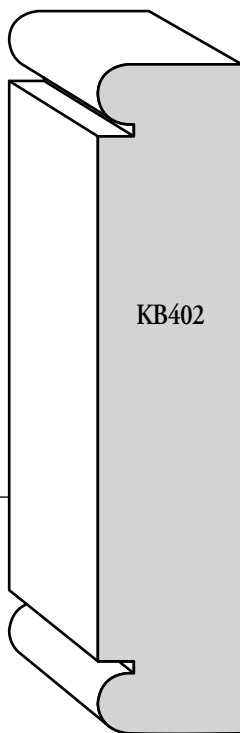

● Clear Pine

○ Primed FJ Pine

▲ Primed FJ Poplar

☛ Lightweight Primed MDF



Chair Rail Mouldings

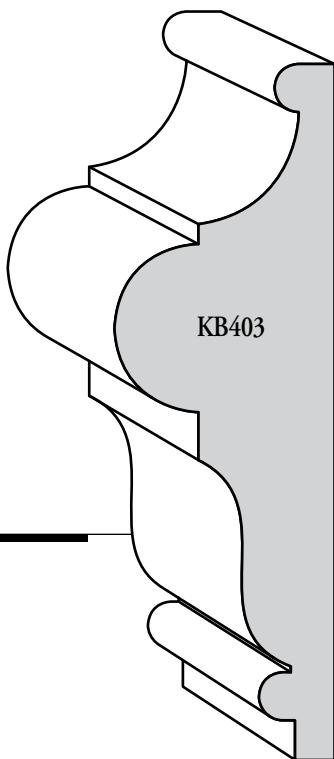
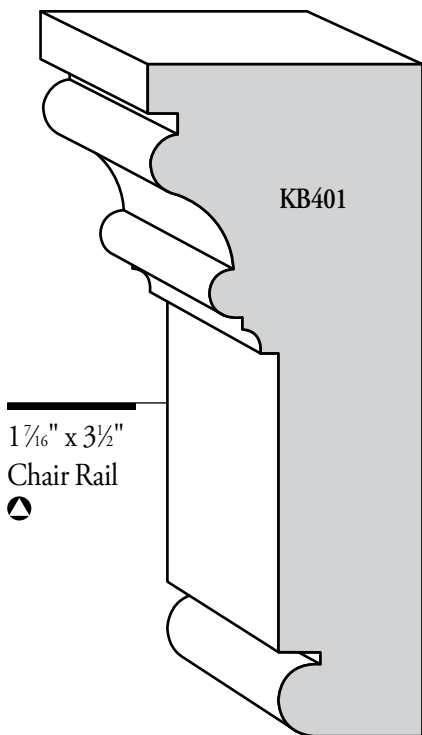

● Clear Pine

○ Primed FJ Pine

▲ Primed FJ Poplar

✎ Lightweight Primed MDF



Chair Rail Mouldings

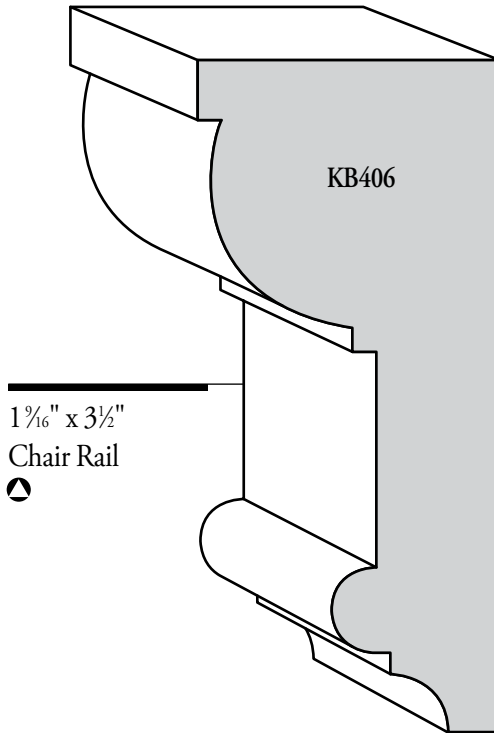



Chair Rail Mouldings

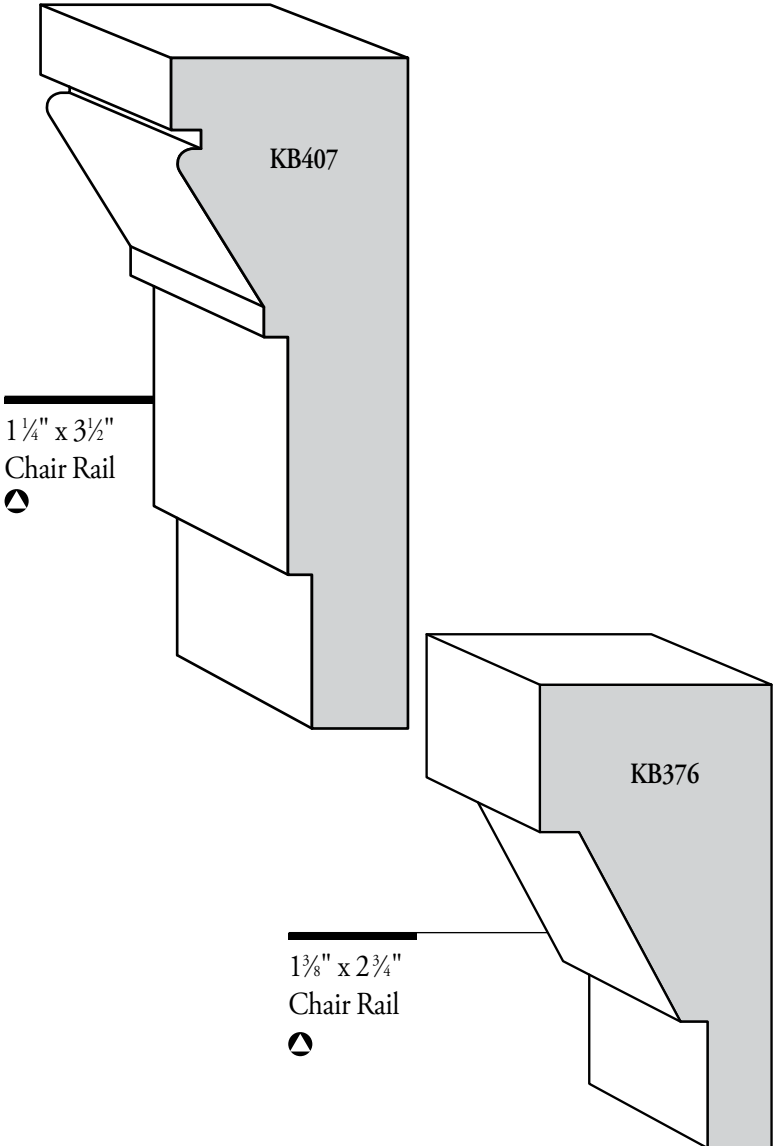

- Clear Pine
- Primed FJ Pine
- Primed FJ Poplar
- 🍃 Lightweight Primed MDF

Chair Rail Mouldings

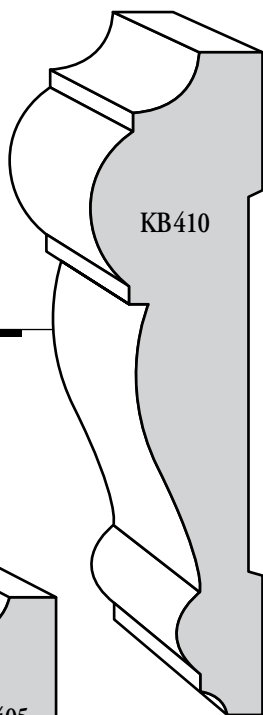

$\frac{7}{8}$ " x $3\frac{1}{2}$ "
Heavy Norman
Chair Rail

○

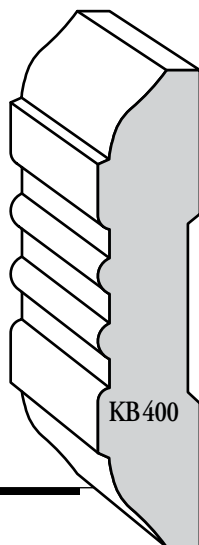

$\frac{1}{16}$ " x $2\frac{1}{2}$ "
Fluted Chair Rail

○

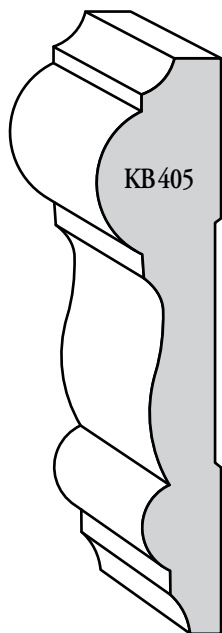

$1\frac{1}{16}$ " x 3"
Norman Chair Rail

○

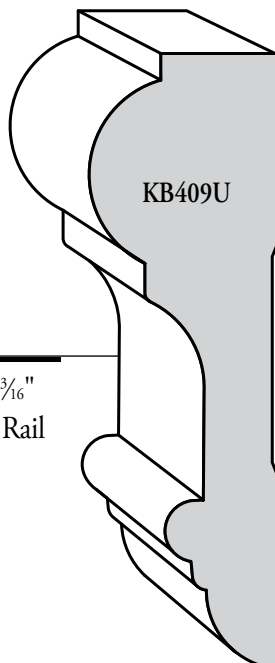

1" x $3\frac{3}{16}$ "
Chair Rail

◐

● Clear Pine

○ Primed FJ Pine

◐ Primed FJ Poplar

◑ Lightweight Primed MDF



Panel Mouldings

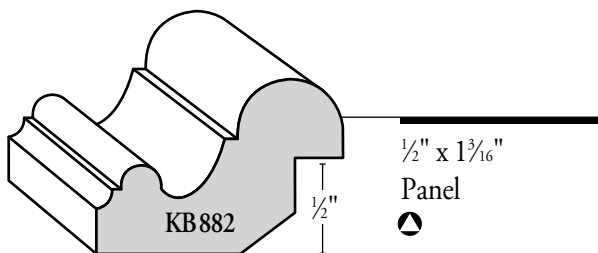
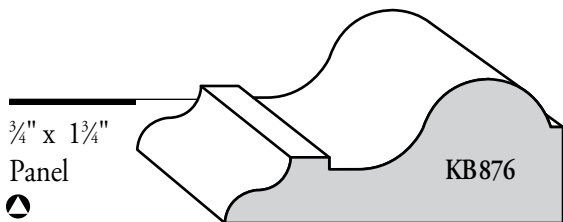
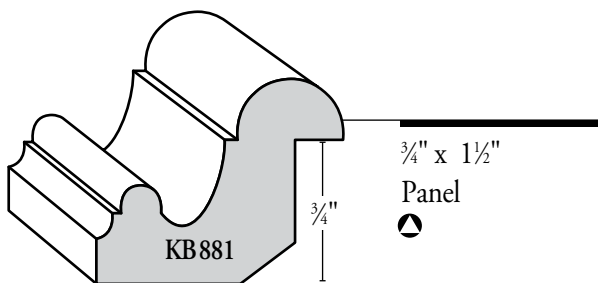
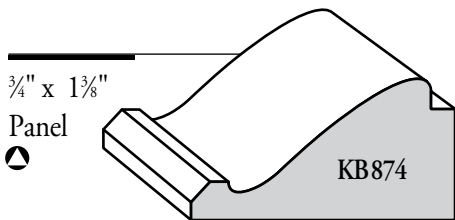

● Clear Pine

○ Primed FJ Pine

▲ Primed FJ Poplar

☛ Lightweight Primed MDF



Panel Mouldings

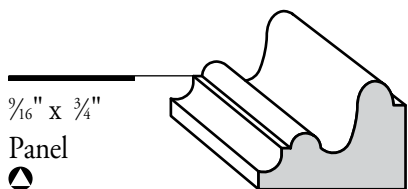

$\frac{9}{16}$ " x $\frac{3}{4}$ "

Panel



KB873

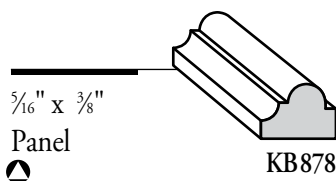

$\frac{5}{16}$ " x $\frac{3}{8}$ "

Panel



KB878

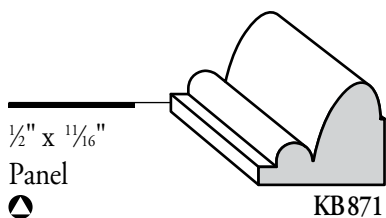

$\frac{1}{2}$ " x $\frac{1}{16}$ "

Panel



KB871

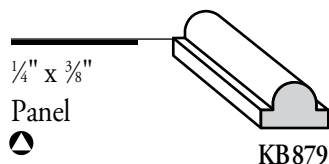

$\frac{1}{4}$ " x $\frac{3}{8}$ "

Panel



KB879

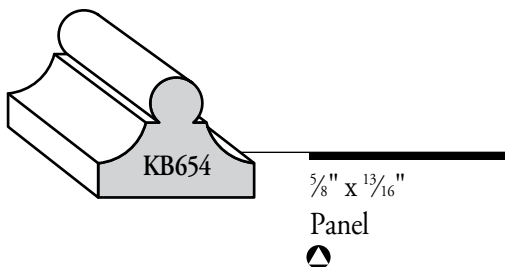

KB654

$\frac{5}{8}$ " x $\frac{13}{16}$ "

Panel



● Clear Pine

○ Primed FJ Pine

▲ Primed FJ Poplar

☛ Lightweight Primed MDF



Panel Mouldings

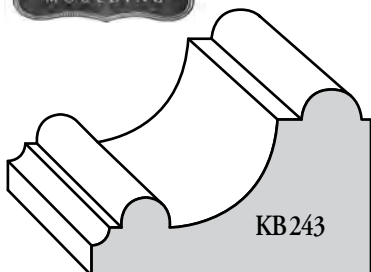

1" x 1¹/₁₆"

Panel

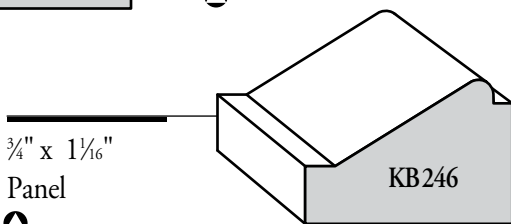

3/4" x 1¹/₁₆"

Panel

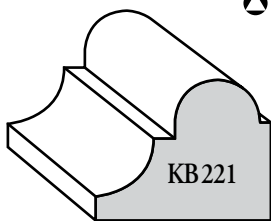

3/4" x 1⁵/₁₆"

Panel

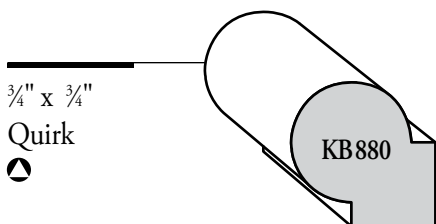

3/4" x 3/4"

Quirk

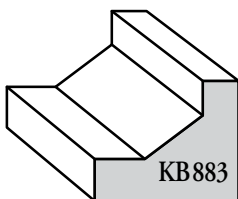

5/8" x 3/4"

Panel



● Clear Pine

○ Primed FJ Pine

▲ Primed FJ Poplar

✎ Lightweight Primed MDF



Panel Mouldings

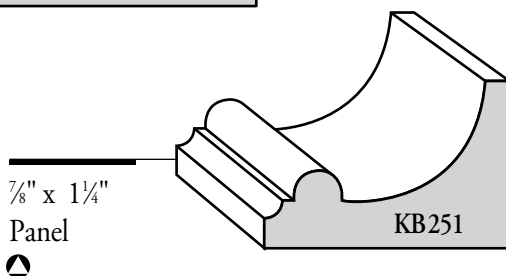
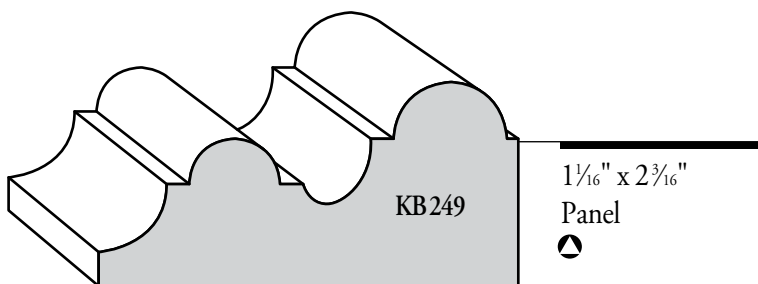
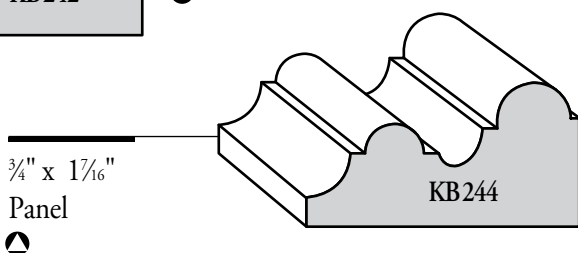
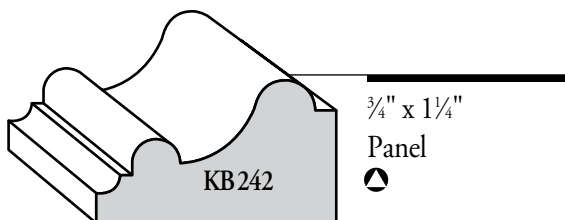

Panel Mouldings

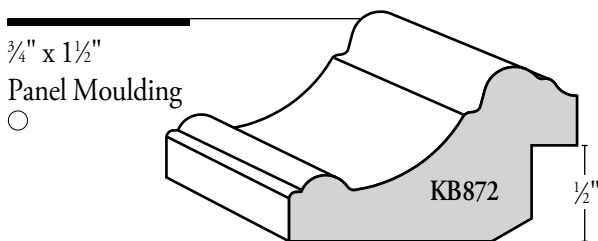
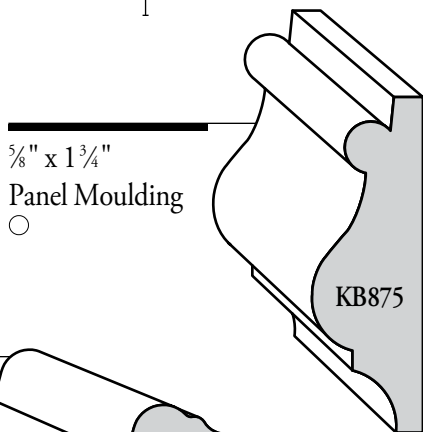
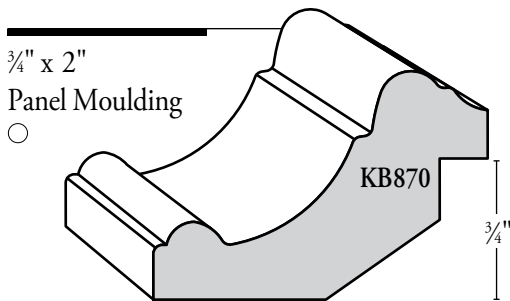
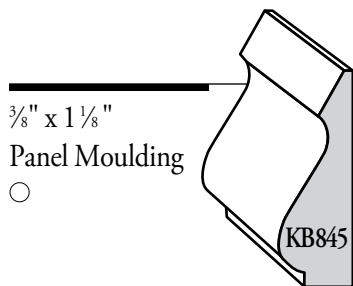



Chair Rail & Panel



Chair Rail KB403, Panel KB242, Base KB227

Quarter Round Mouldings



$\frac{1}{4}$ " Quarter Round



KB255

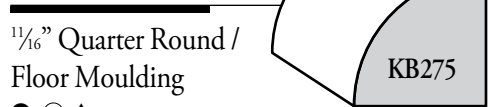

$\frac{1}{16}$ " Quarter Round /
Floor Moulding



KB275

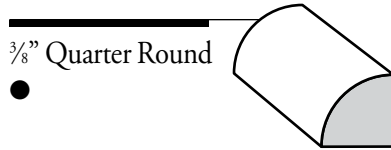

$\frac{3}{8}$ " Quarter Round



KB260

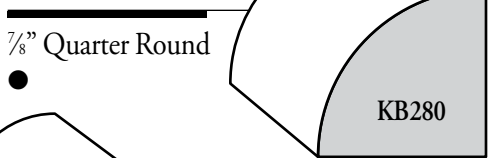

$\frac{7}{8}$ " Quarter Round



KB280

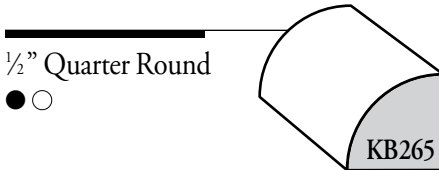

$\frac{1}{2}$ " Quarter Round



KB265

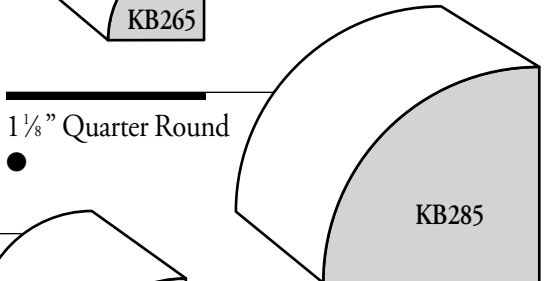

$1\frac{1}{8}$ " Quarter Round



KB285

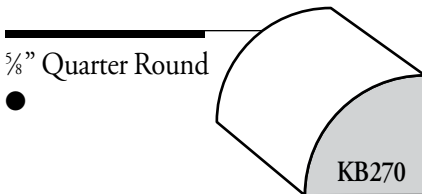

$\frac{5}{8}$ " Quarter Round



KB270

Hand Rails

1⁹/₁₆" x 1¹¹/₁₆"
Hand Rail

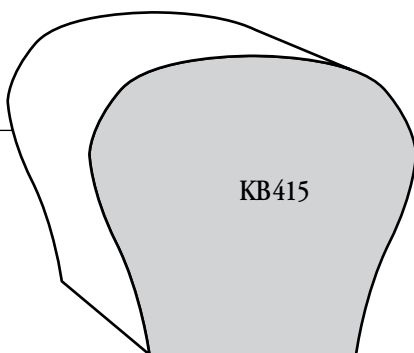

KB430
OAK

2¹/₄" x 2³/₈"
10', 12', 14', 16'
Hand Rail

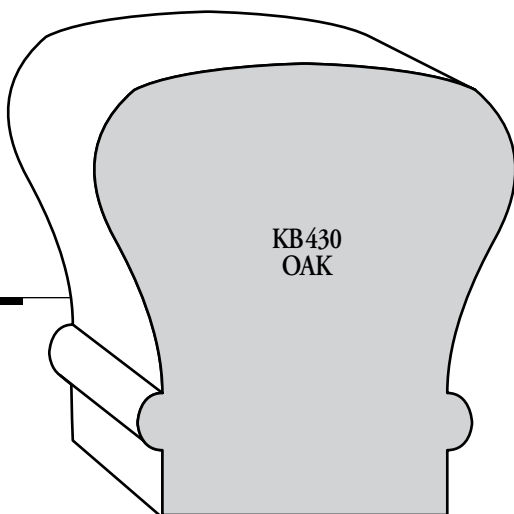

● Clear Pine

○ Primed
FJ Pine

▲ Oak

◐ Primed FJ Poplar

◑ Lightweight Primed MDF

Hand Rails

1½" x 2¼"
Hand Rail

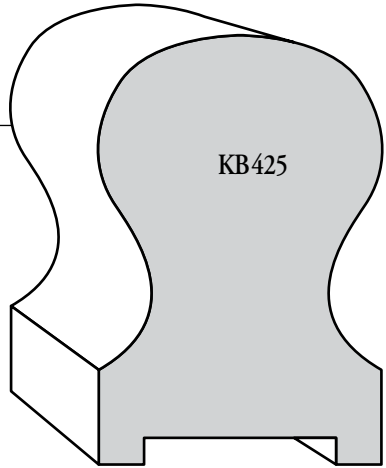

KB425

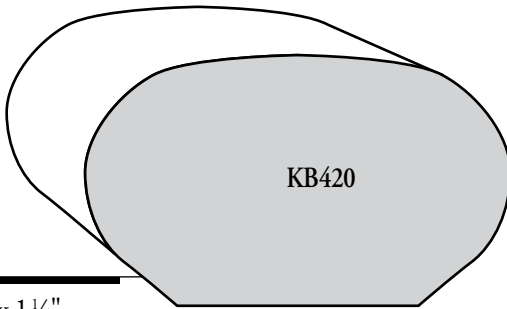

KB420

2¼" x 1¼"
Oval Hand Rail



● Clear Pine

○ Primed
FJ Pine

▲ Oak

◐ Primed FJ Poplar

☛ Lightweight Primed MDF

Stop Mouldings

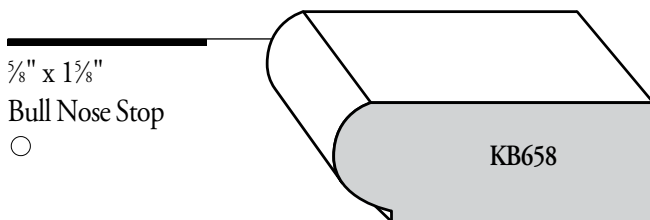
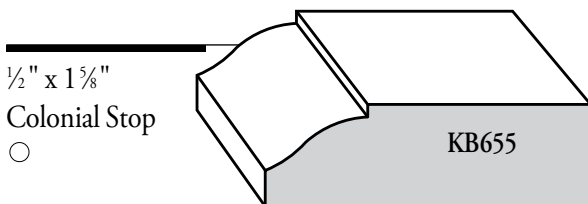
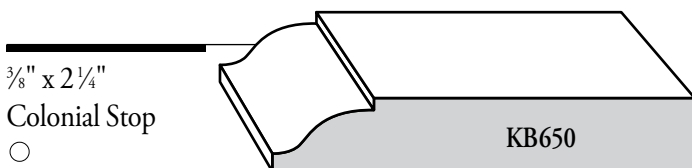
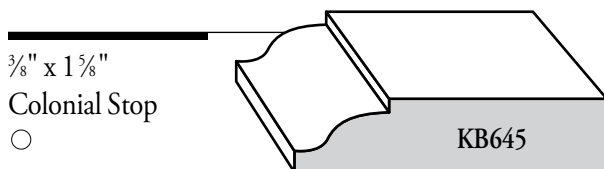

Stop Mouldings

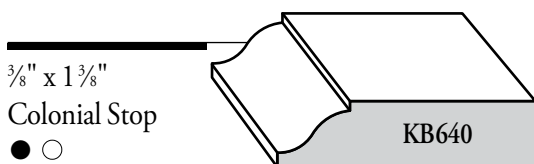
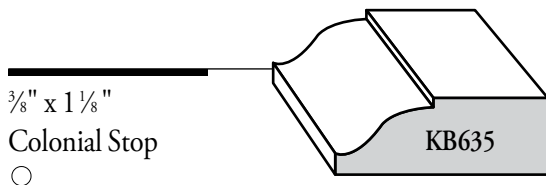
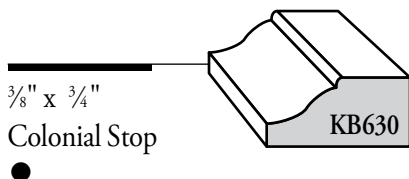

● Clear Pine

○ Primed FJ Pine

▲ Primed FJ Poplar

☙ Lightweight Primed MDF

Shoe & Stop Mouldings

$\frac{1}{2}'' \times \frac{3}{4}''$

Shoe Moulding



Flex In-Stock (8', 10', 12' lengths)

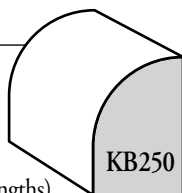

$\frac{3}{8}'' \times \frac{3}{4}''$

Clam Stop

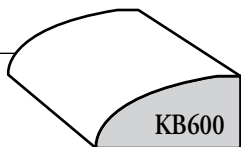

$\frac{3}{8}'' \times 1 \frac{1}{8}''$

Clam Stop

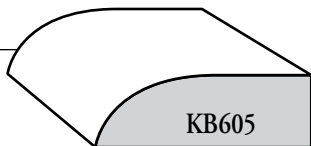

$\frac{3}{8}'' \times 1 \frac{3}{8}''$

Clam Stop

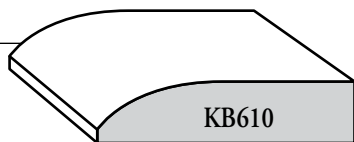

$\frac{3}{8}'' \times 1 \frac{5}{8}''$

Clam Stop

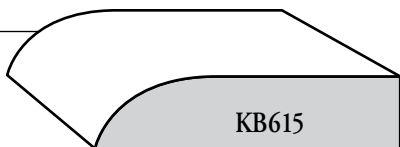

Baluster

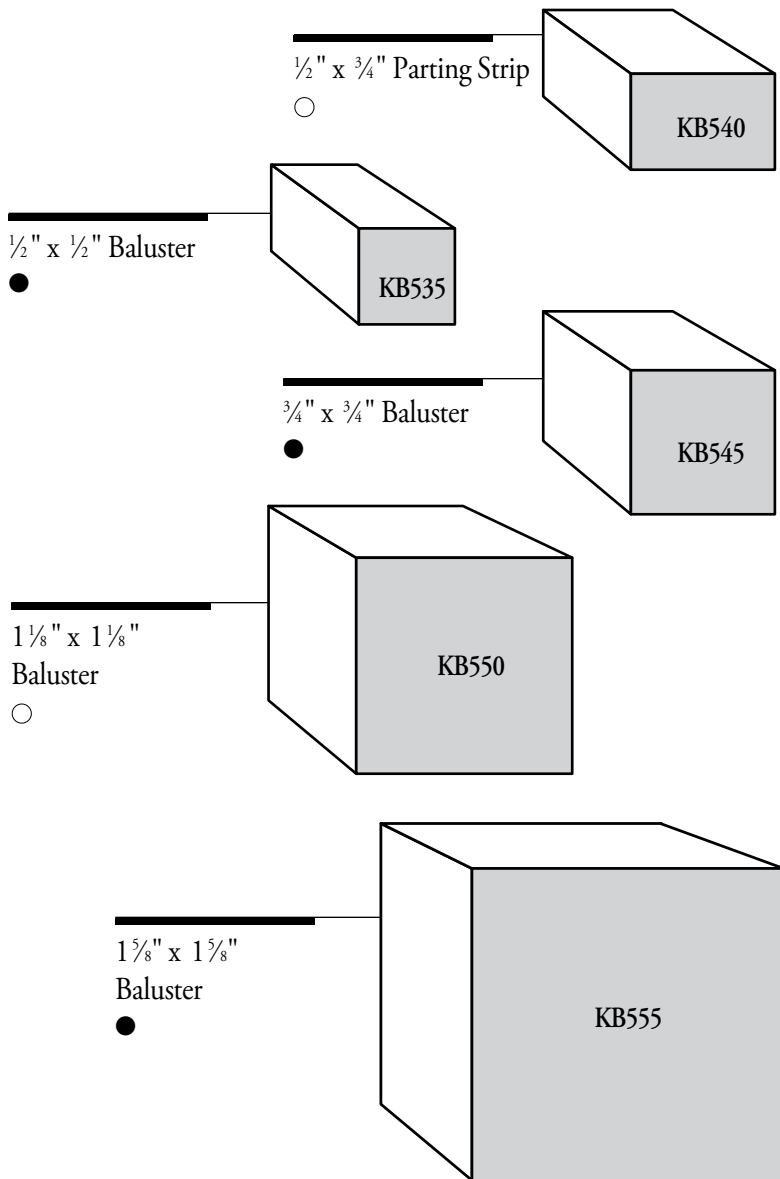

● Clear Pine

○ Primed FJ Pine

▲ Oak

◐ Primed FJ Poplar

◑ Lightweight Primed MDF

Lattice Mouldings

● $\frac{1}{4}$ " x $\frac{3}{4}$ " Lattice

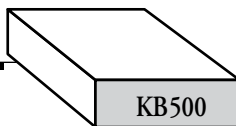

● $\frac{1}{4}$ " x $1\frac{1}{8}$ " Lattice

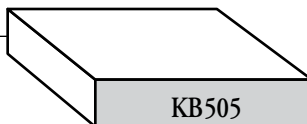

● $\frac{1}{4}$ " x $1\frac{3}{8}$ " Lattice

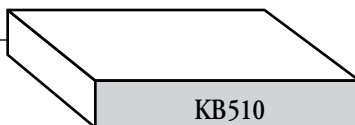

● $\frac{1}{4}$ " x $1\frac{5}{8}$ " Lattice

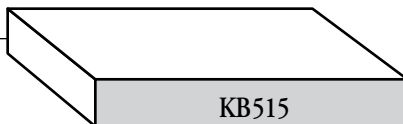

● $\frac{1}{4}$ " x $2\frac{5}{8}$ " Lattice

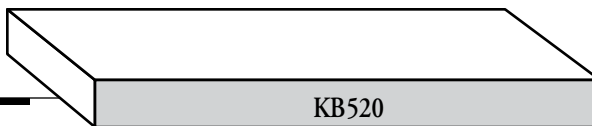

● $\frac{1}{4}$ " x $3\frac{1}{2}$ " Lattice

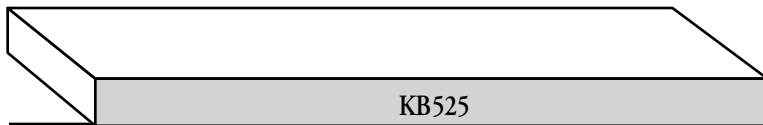

● $\frac{1}{4}$ " x $5\frac{1}{4}$ " Lattice

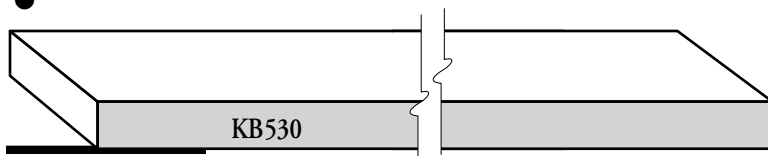

Pole Mouldings

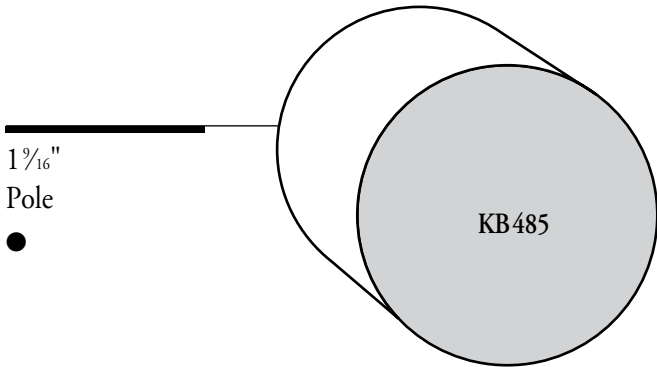
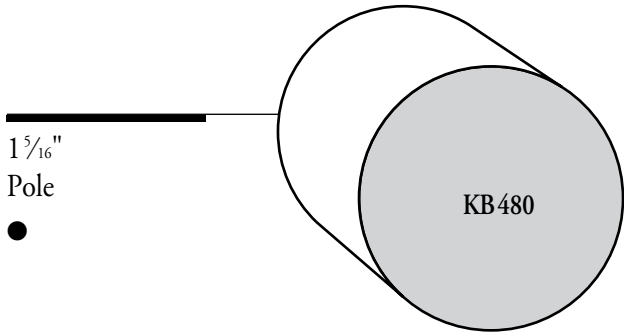

Kuiken Brothers stocks white melamine shelving boards, adjustable steel closet rods, closet rod hardware and cedar closet lining for custom built closets.

● Clear Pine

○ Primed FJ Pine

◐ Primed FJ Poplar

◑ Lightweight Primed MDF

Half Round Mouldings

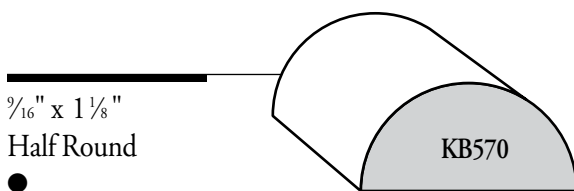
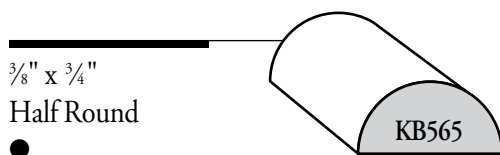
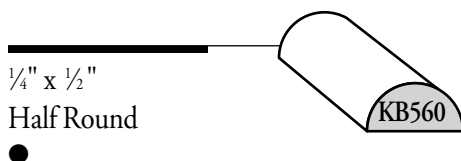

Astragal & Mullion Center

$\frac{3}{8}$ " x $\frac{7}{8}$ "

Astragal

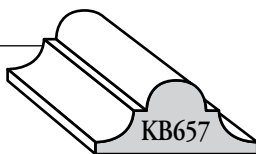

$\frac{7}{16}$ " x $1\frac{1}{8}$ "

Astragal

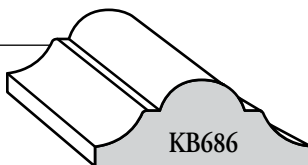

$1\frac{1}{16}$ " x $1\frac{3}{8}$ "

Astragal

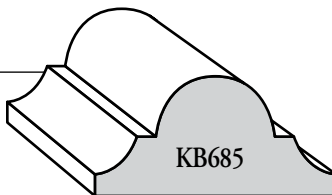

$\frac{5}{8}$ " x $1\frac{13}{16}$ "

Astragal

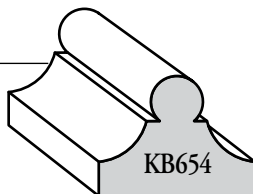

Astragal & Mullion Center

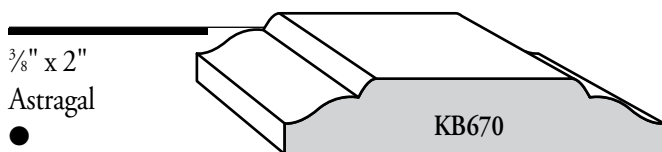
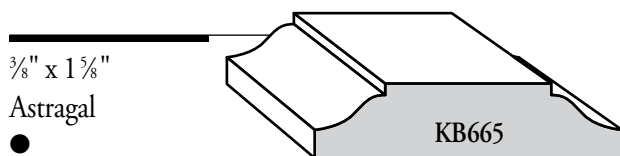
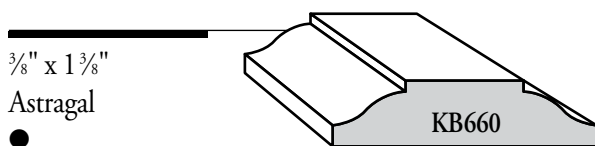

Sanitary Corner Guard

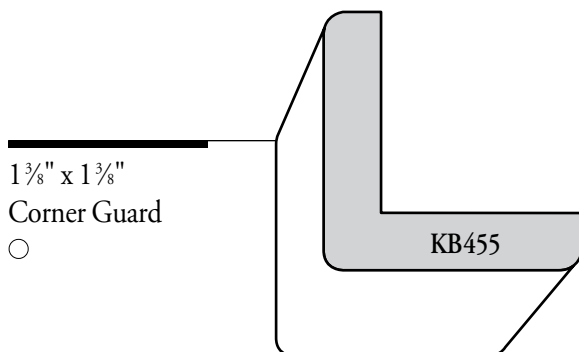
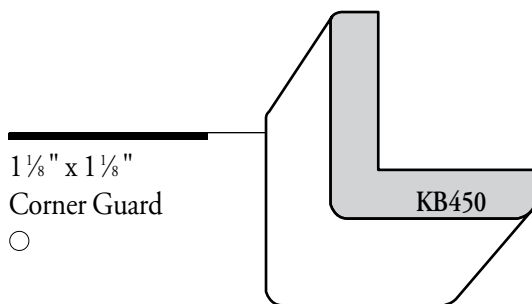
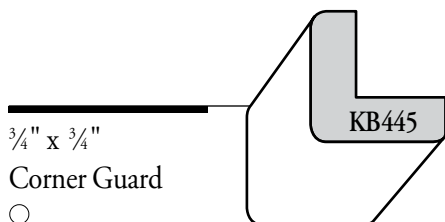

● Clear Pine

○ Primed FJ Pine

▲ Primed FJ Poplar

🍃 Lightweight Primed MDF

Colonial Corner Guard

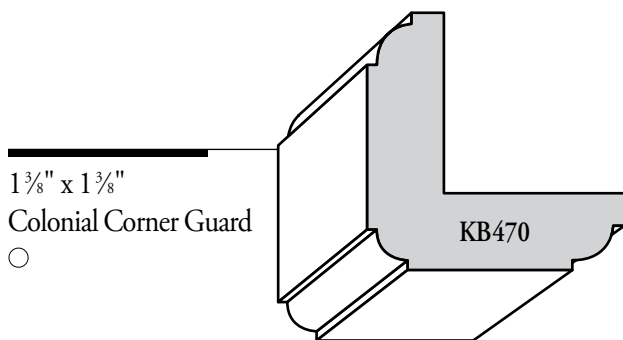
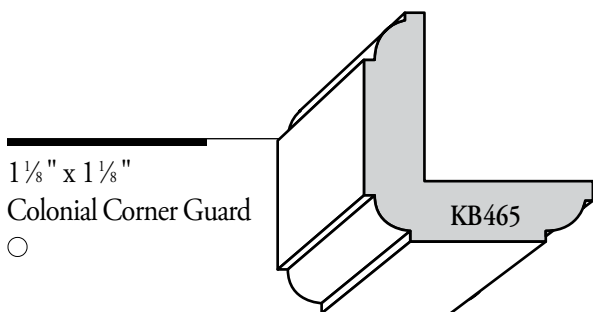

Glass Bead & Picture Rail

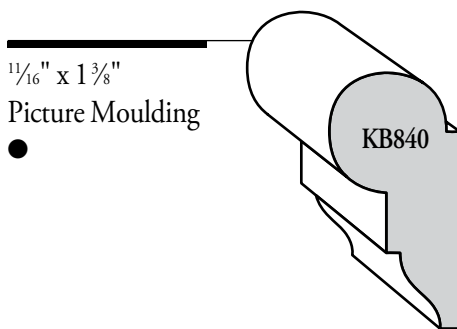
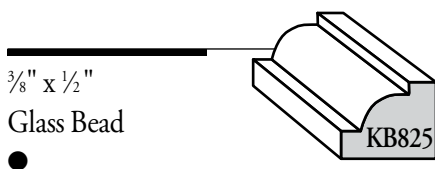

Drip Cap & Brick Moulding

$1\frac{1}{16}$ " x $1\frac{5}{8}$ "

Drip Cap Moulding

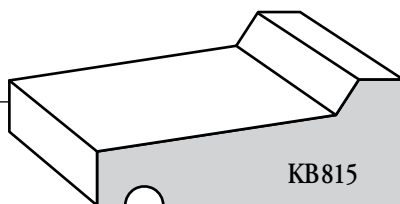

$1\frac{1}{8}$ " x 2"

Flat Casing

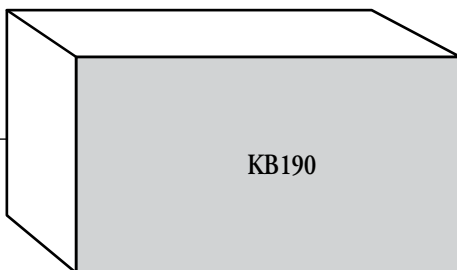

$1\frac{1}{4}$ " x 2"

Brick Moulding

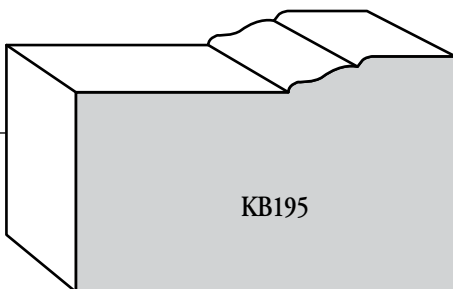

Shelf Edge & Skewback

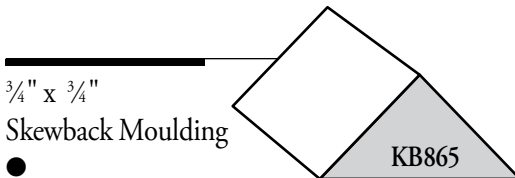
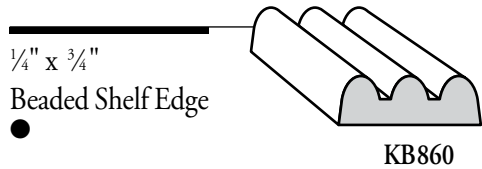
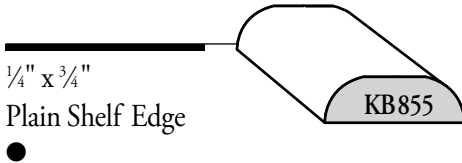

● Clear Pine

○ Primed FJ Pine

▲ Primed FJ Poplar

☙ Lightweight Primed MDF

Extension Jamb

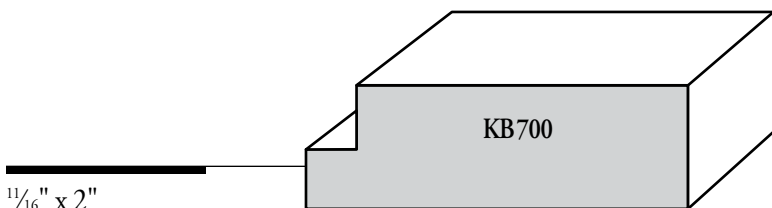

$1\frac{1}{16}$ " x 2"

Andersen Extension Jamb "Casement & Awning"

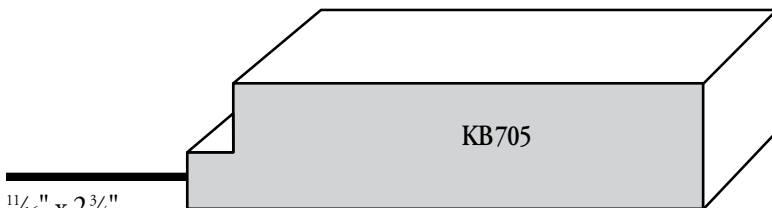

$1\frac{1}{16}$ " x $2\frac{3}{4}$ "

Andersen Extension Jamb "Casement & Awning"

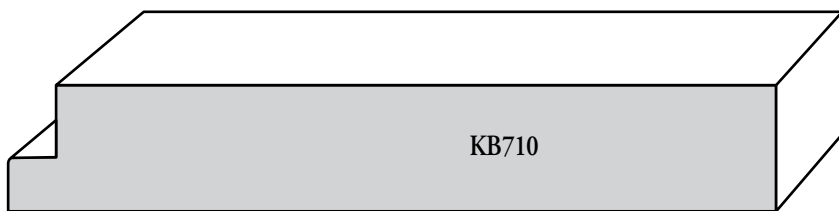

$1\frac{1}{16}$ " x 4"

Andersen Extension Jamb "Casement & Awning"



Extension Jamb

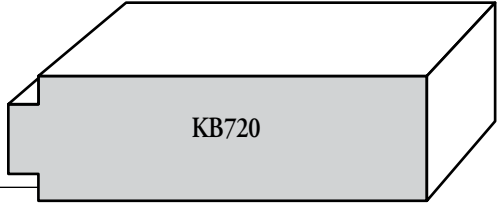

$\frac{1}{16}'' \times 2\frac{3}{16}''$

Andersen Tilt Wash Extension Jamb

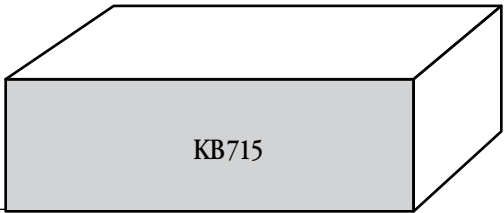

$\frac{1}{16}'' \times 2\frac{1}{8}''$

Andersen Narroline Extension Jamb





Window Stool

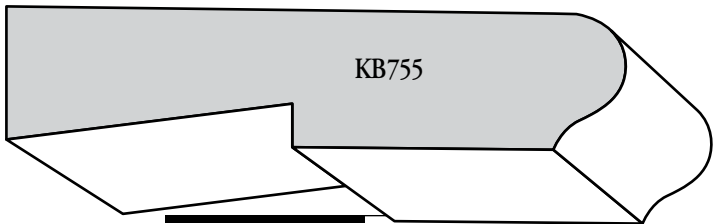

$1\frac{1}{16}$ " x $3\frac{1}{4}$ " Window Stool

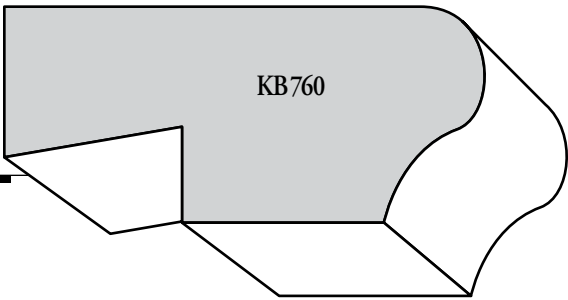

$1\frac{1}{8}$ " x $2\frac{1}{2}$ "
Window Stool

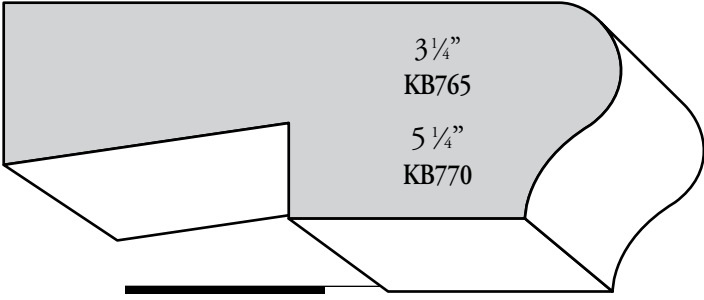

$1\frac{1}{8}$ " x $3\frac{1}{4}$ " Window Stool ○

$1\frac{1}{8}$ " x $5\frac{1}{4}$ " Window Stool ○

Window Stool

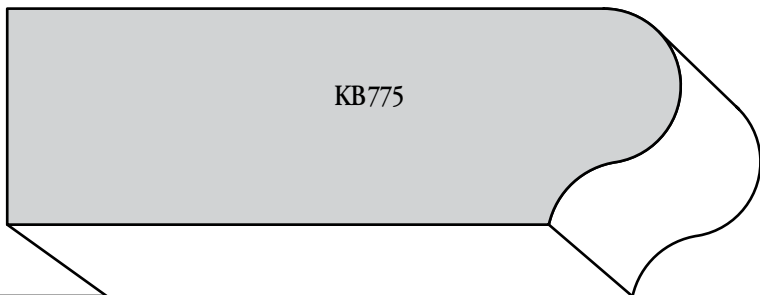

1 1/8" x 3 1/2"

Flat Bottom Stool

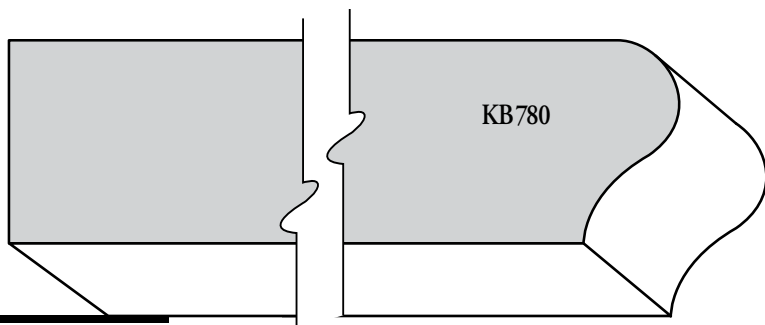

1 1/16" x 5 1/4"

Flat Bottom Stool



● Clear Pine

○ Primed FJ Pine

▲ Primed FJ Poplar

☛ Lightweight Primed MDF

Window Stool

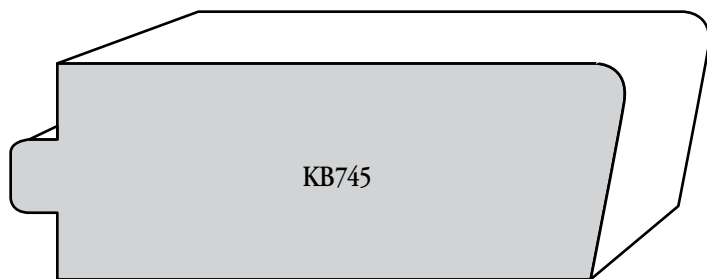

1 1/8" x 3 1/4"

Andersen Window Stool "Casement & Awning"

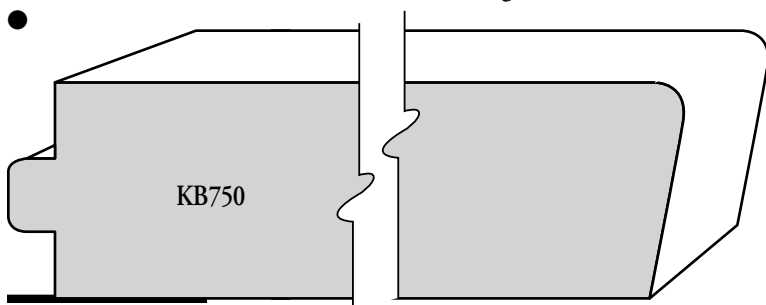

1 1/8" x 5 3/4"

Andersen Window Stool "Casement & Awning"

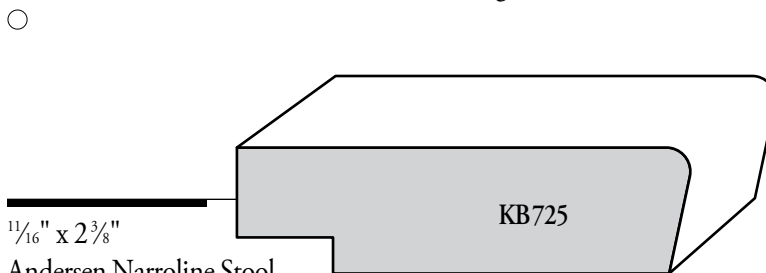

1 1/16" x 2 3/8"

Andersen Narroline Stool



Window Stool

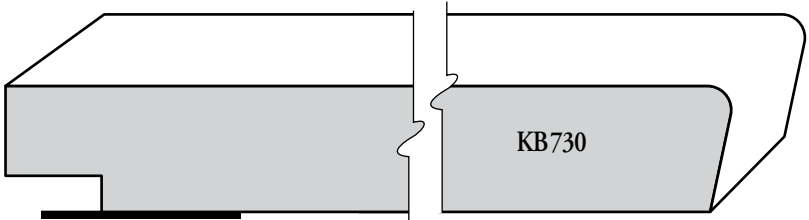

$1\frac{1}{16}$ " x $4\frac{3}{8}$ "

Andersen Narroline Stool

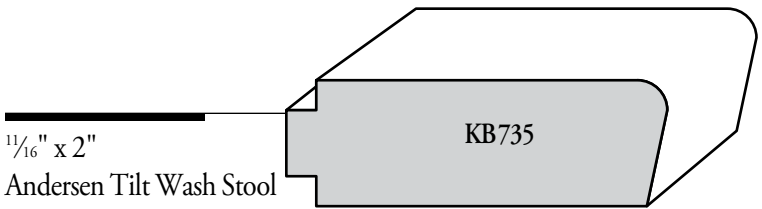

$1\frac{1}{16}$ " x 2"

Andersen Tilt Wash Stool

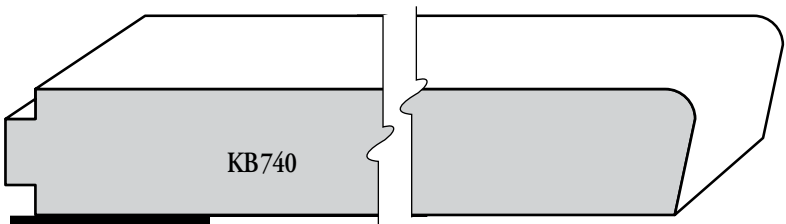

$1\frac{1}{16}$ " x 4"

Andersen Tilt Wash Stool



Clear Pine

Primed FJ Pine

Primed FJ Poplar

Lightweight Primed MDF

Window Sill & Stool

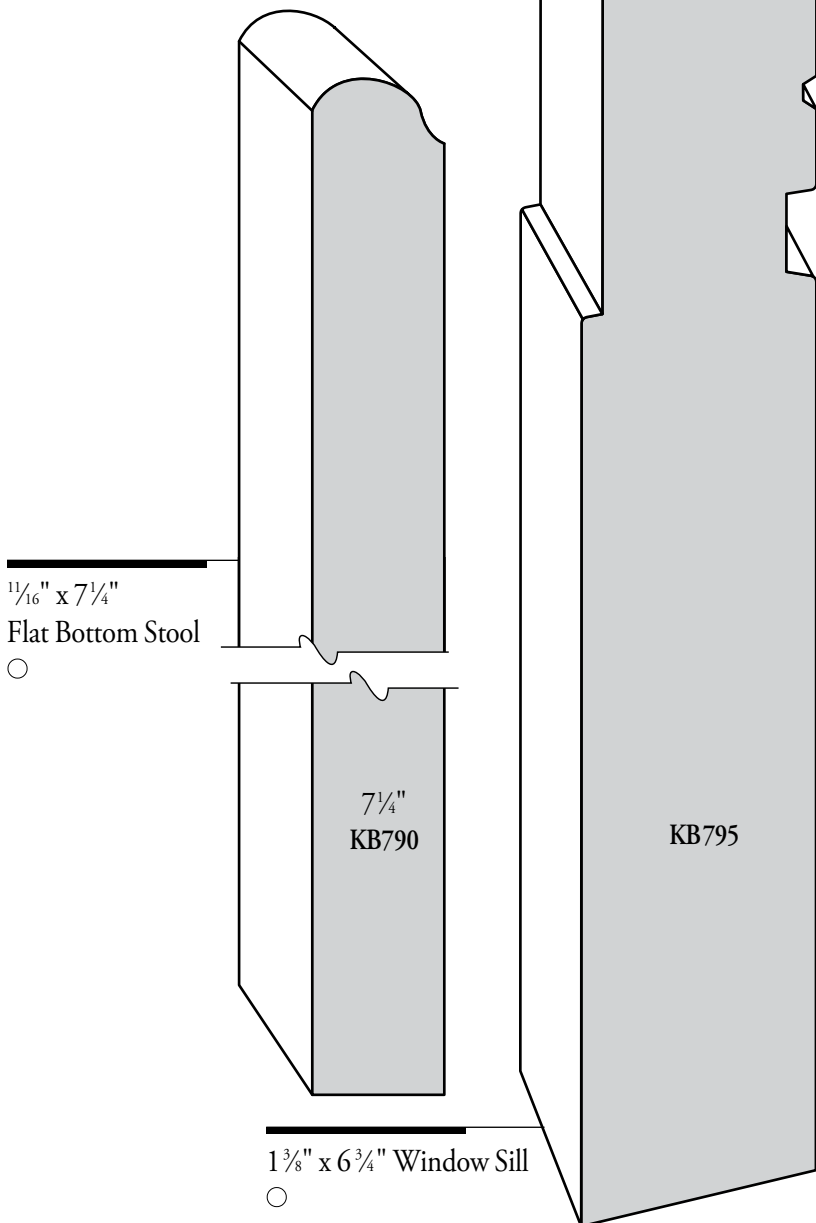

$1\frac{1}{16}'' \times 7\frac{1}{4}''$
Flat Bottom Stool

○

$7\frac{1}{4}''$
KB790

KB795

$1\frac{3}{8}'' \times 6\frac{3}{4}''$ Window Sill

○

- Clear Pine
- Primed FJ Pine
- ▲ Oak
- ◐ Primed FJ Poplar
- ◑ Lightweight Primed MDF

Hearth Border, Landing Tread & Nosing

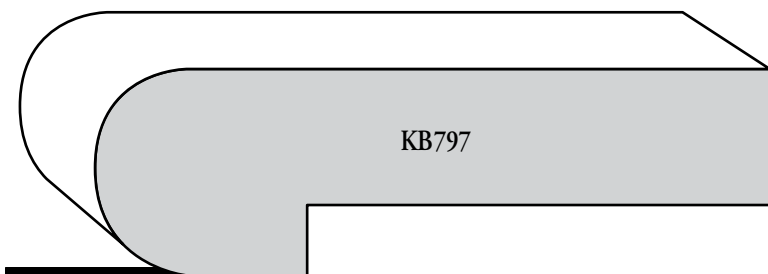
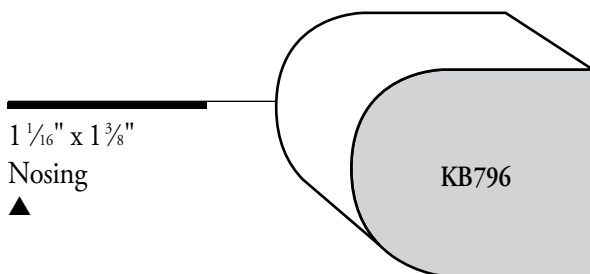
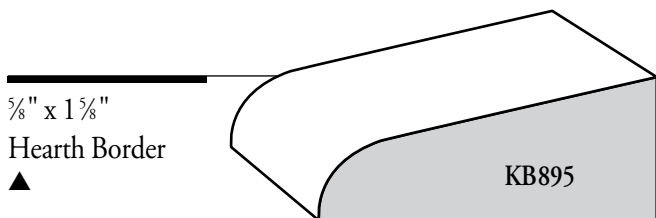

$1\frac{1}{8}$ " x $3\frac{1}{2}$ "
Landing Tread
▲

● Clear Pine ○ Primed FJ Pine ▲ Oak ● Primed FJ Poplar 🍃 Lightweight Primed MDF

Door Sills & Saddles

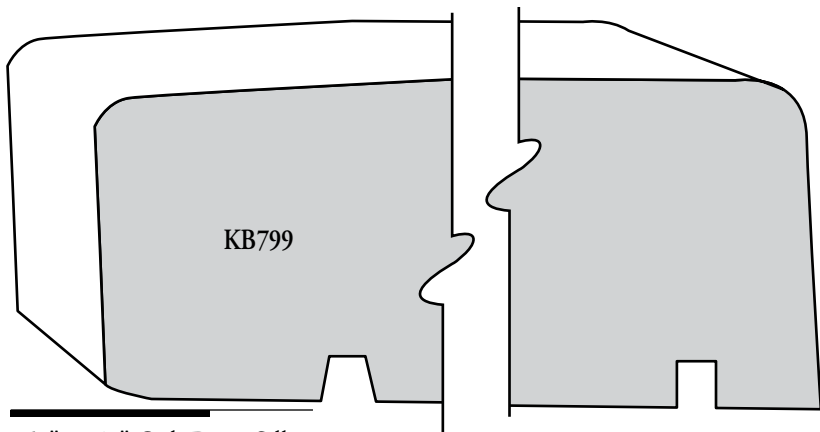

KB799

1 5/8" x 7 1/4" Oak Door Sill

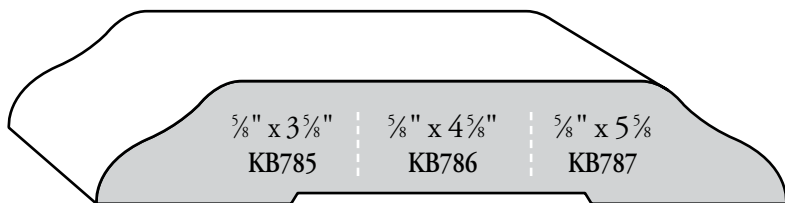

5/8" x 3 5/8"

KB785

5/8" x 4 5/8"

KB786

5/8" x 5 5/8"

KB787

Oak Saddle



● Clear Pine

○ Primed FJ Pine

▲ Oak

◐ Primed FJ Poplar

🍃 Lightweight Primed MDF

Plinth Blocks

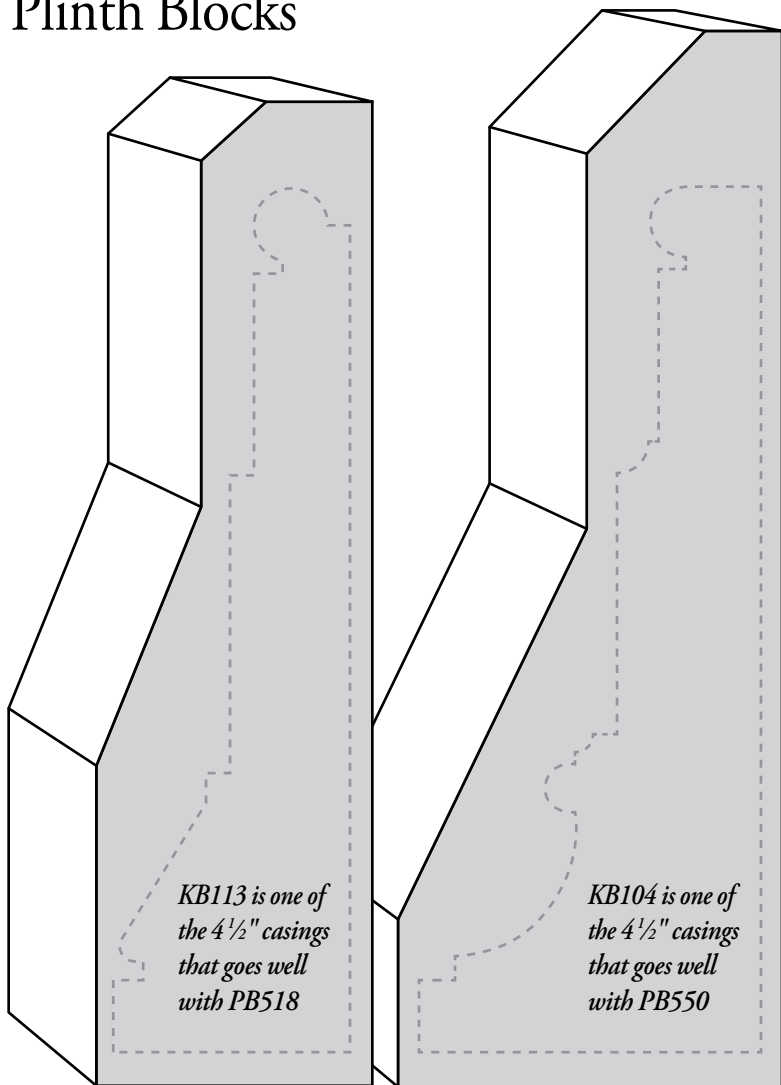

*KB113 is one of
the 4 1/2" casings
that goes well
with PB518*

*KB104 is one of
the 4 1/2" casings
that goes well
with PB550*

PB518*

1 7/16" x 5 1/8"

Plinth Block



PB550*

2" x 5 1/2"

Plinth Block



PB418 (1 1/4" x 4 1/8") is also available for 3 1/2" casings

**Short lead time required.*

ROSETTES

Wellington



- WEL212 (1" x 2-1/2") ●
- WEL234 (1" x 2-3/4") ● ▲
- WEL312 (1" x 3-1/2") ● ▲
- WEL334 (1" x 3-3/4") ● ▲
- WEL412 (1" x 4-1/2") ● ▲
- WEL500 (1-5/16" x 5") △
- WEL834 (1-1/4" x 3-3/4") ●
- WEL414 (1-1/4" x 4-1/4") ●
- WEL512 (1-1/4" x 5-1/2") ● ▲

Cambridge



- CAM312 (1" x 3-1/2") ● ▲
- CAM334 (1" x 3-3/4") ● ▲ △
- CAM834 (1-1/4" x 3-3/4") ●
- CAM434 (1" x 4-3/4") ●
- CAM512 (1-1/4" x 5-1/2") ●
- CAM712 (1-1/4" x 7-1/2") ●

ARCH ROSETTES



- WA234 (1" x 2-3/4" x 4-1/2") ●
- WA334 (1" x 3-3/4" x 6") ●
- WA834 (1-5/16" x 3-3/4" x 7") △

PLINTH BLOCKS

Pilaster



- PPB512 (1-1/8" x 5-1/2" x 8") ●
- PPB712 (1-1/8" x 7-1/2" x 8") ●

Bridgeford



- BRI234 (1" x 2-3/4" x 6") ● ▲
- BRI312 (1" x 3-1/2" x 6") ● ▲
- BRI334 (1" x 3-3/4" x 6") ● ▲
- BRI833 (1-1/8" x 4-1/2" x 8") ▲
- BRI434 (1" x 4-3/4" x 6") ▲

Lexington (daisy)



- LEX312 (7/8" x 3-1/2") ▲ △

KEYSTONES



- KEY312 (1" x 3-1/2") ●
- KEY412 (1" x 4-1/2") ●
- KEY512 (1" x 5-1/2") ●

Wellington



- WPB334 (1" x 3-3/4" x 6") ●

*Rosettes and plinth blocks
can be special ordered in
any size, shape or species
(minimum quantities apply)*

● Clear Pine

△ Poplar

▲ Oak

 KB Ultra

.....
LIGHTWEIGHT PRIMED MDF
.....



KB Ultra

LIGHTWEIGHT PRIMED MDF

$1\frac{3}{16}$ " x $3\frac{1}{2}$ "

Heavy Beaded
Colonial Casing

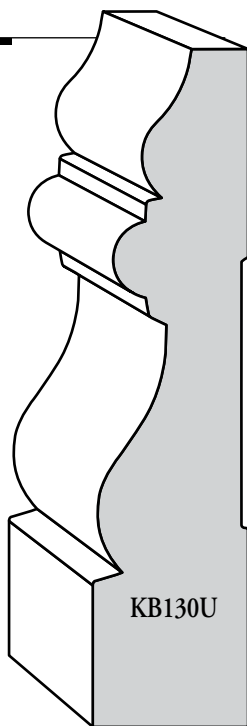

KB130U

1" x $4\frac{1}{4}$ "

Heavy Beaded Colonial Casing

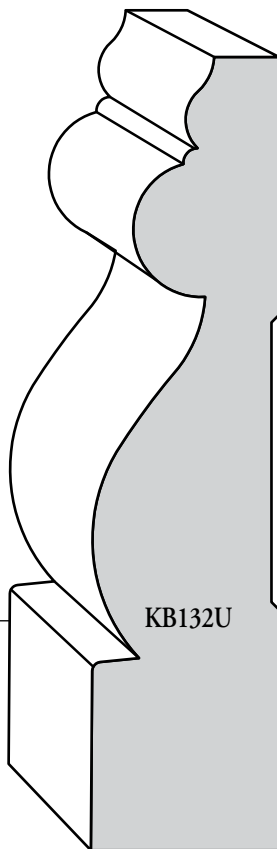

KB132U



LIGHTWEIGHT PRIMED MDF

 **KB Ultra**

LIGHTWEIGHT PRIMED MDF

$\frac{1}{16}$ " x $3\frac{1}{2}$ "

Windsor Casing

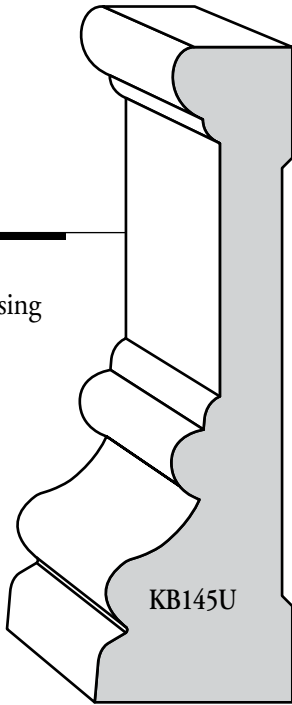

$\frac{1}{16}$ " x $3\frac{1}{2}$ "

Beaded Colonial Casing

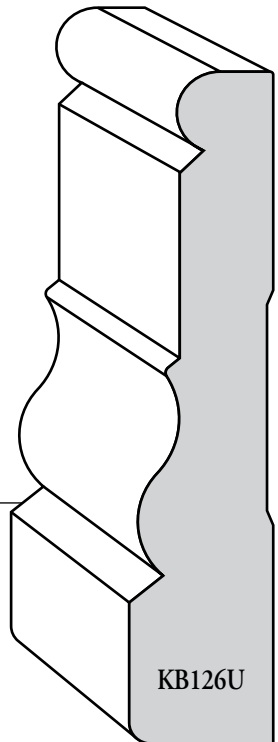

LIGHTWEIGHT PRIMED MDF

KB Ultra
LIGHTWEIGHT PRIMED MDF

$\frac{1}{16}$ " x $6\frac{1}{2}$ "
Special Base

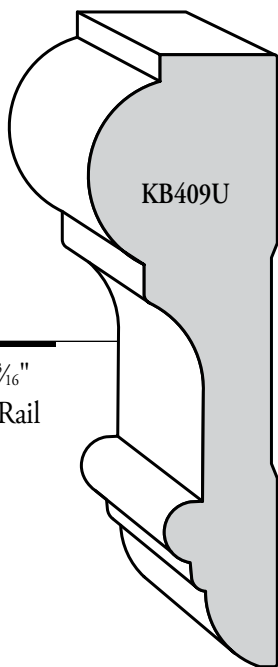

1" x $3\frac{3}{16}$ "
Chair Rail

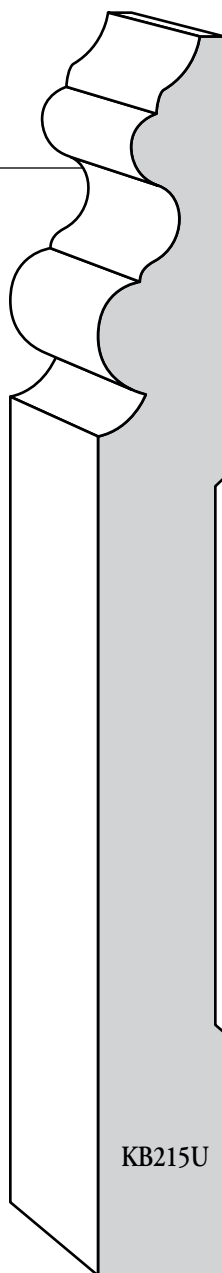

 **KB Ultra**

LIGHTWEIGHT PRIMED MDF

$\frac{7}{8}$ " x $7\frac{1}{2}$ "
Special Base

$1\frac{1}{16}$ " x $4\frac{7}{8}$ "
Special Base

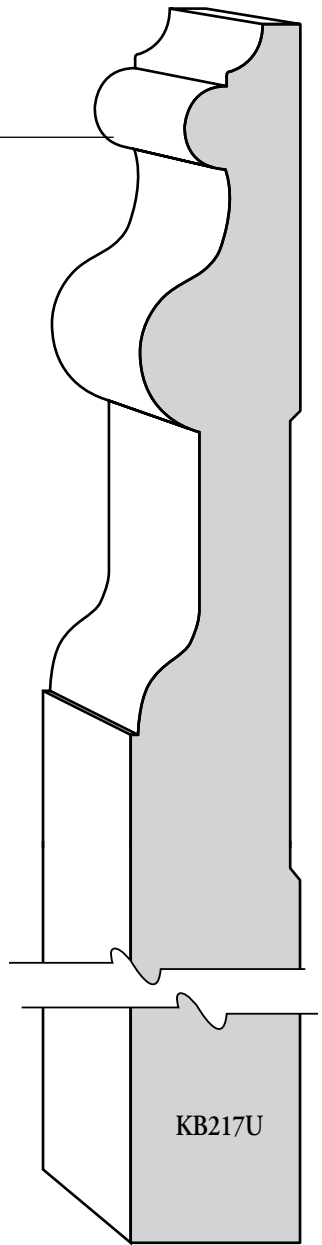
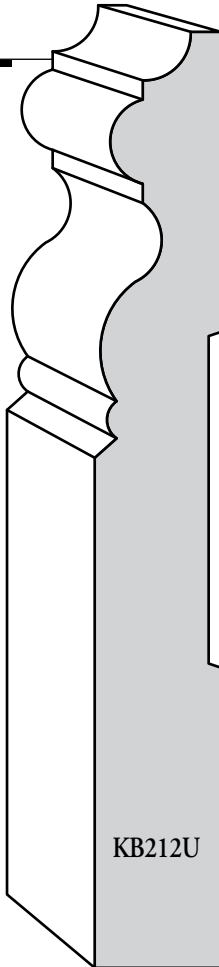

LIGHTWEIGHT PRIMED MDF

KB Ultra
LIGHTWEIGHT PRIMED MDF

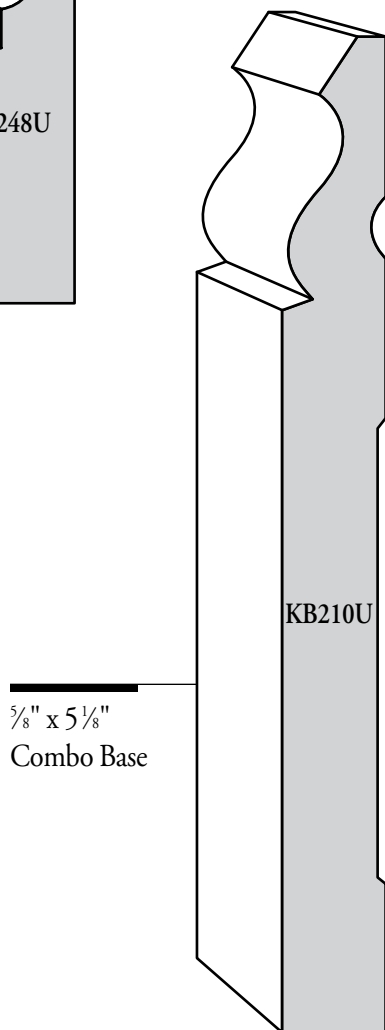
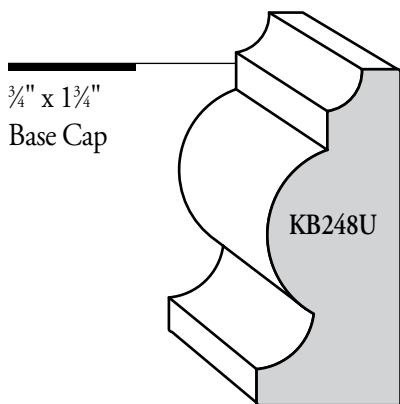

LIGHTWEIGHT PRIMED MDF

 **KB Ultra**
LIGHTWEIGHT PRIMED MDF

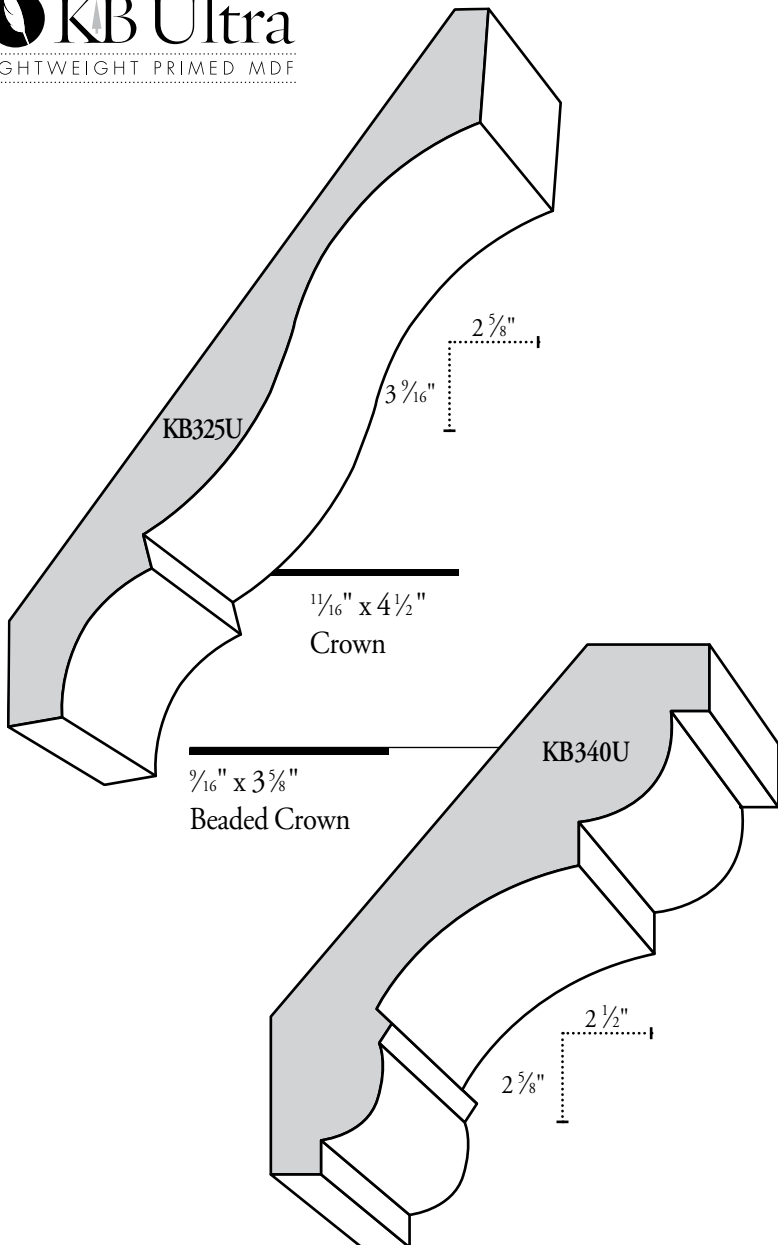

LIGHTWEIGHT PRIMED MDF

KB Ultra
LIGHTWEIGHT PRIMED MDF

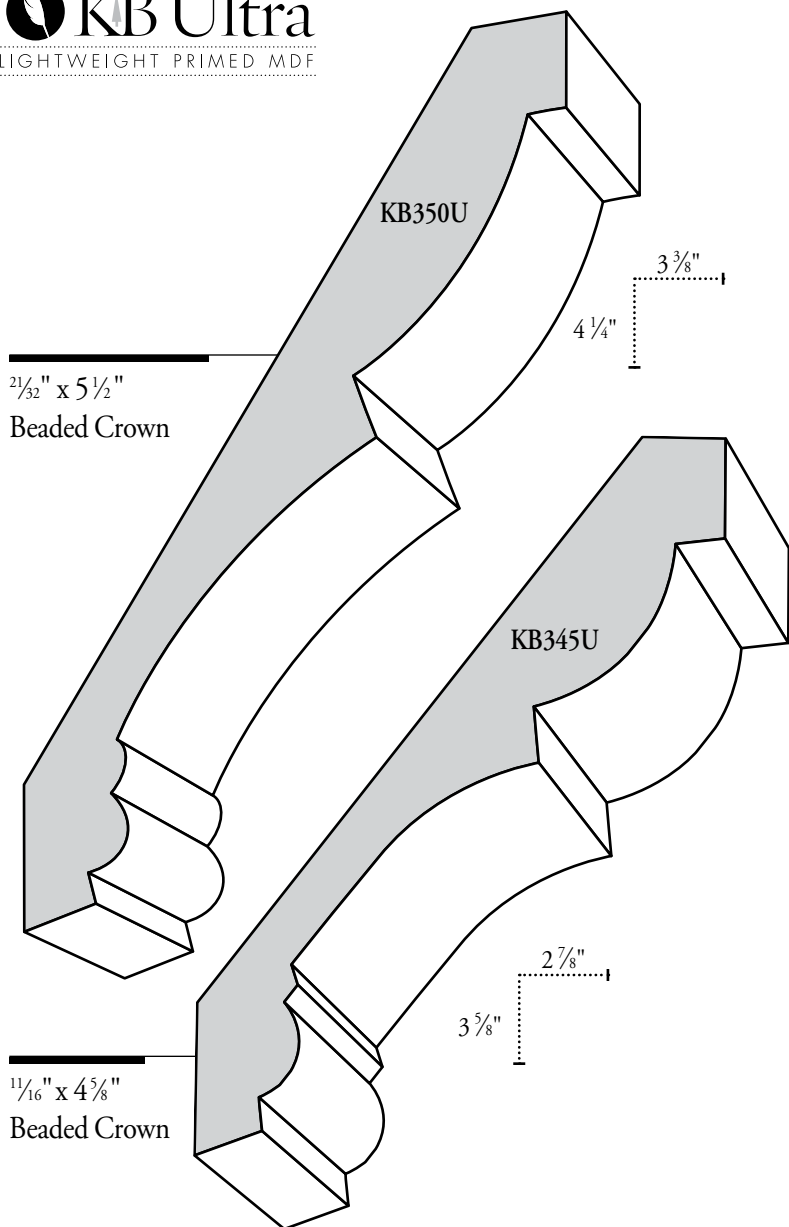

KB Ultra

LIGHTWEIGHT PRIMED MDF

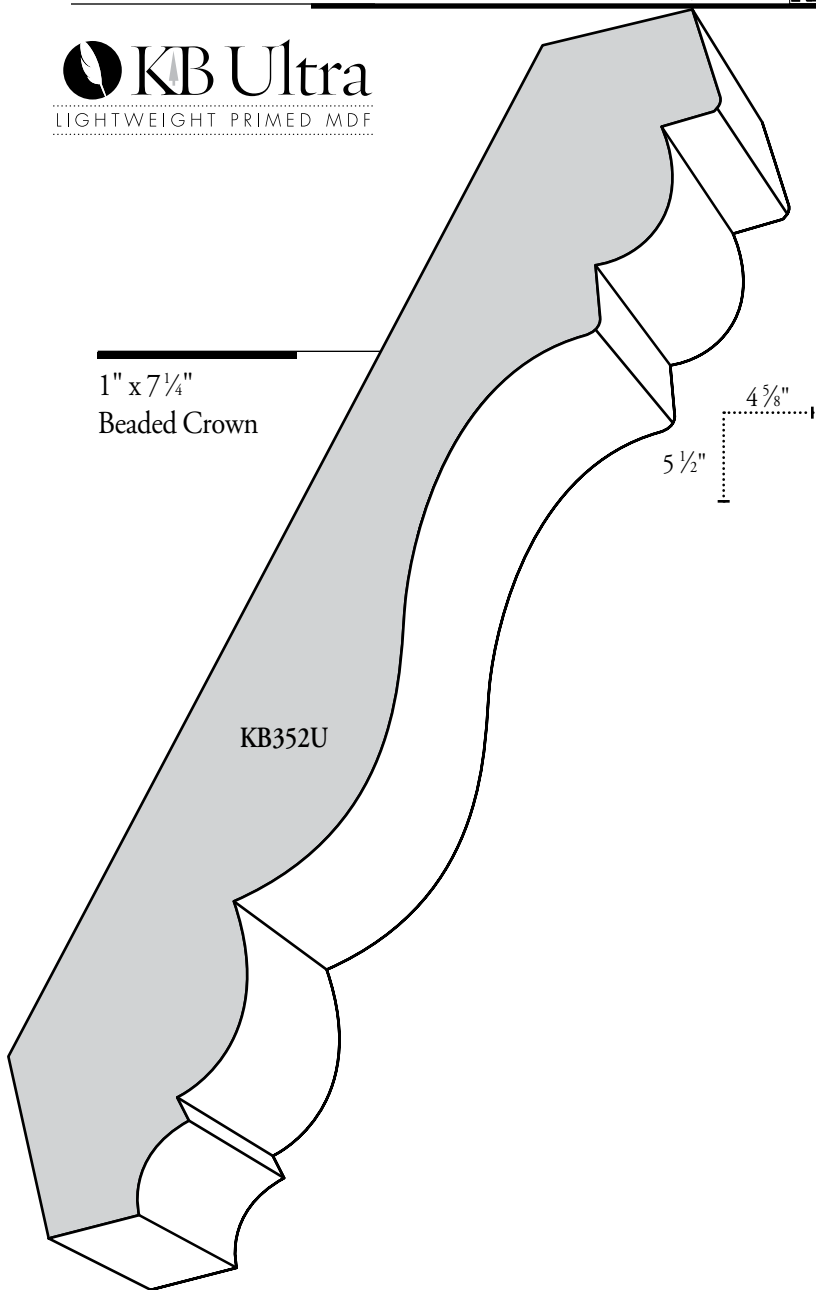

LIGHTWEIGHT PRIMED MDF

KB Ultra
LIGHTWEIGHT PRIMED MDF

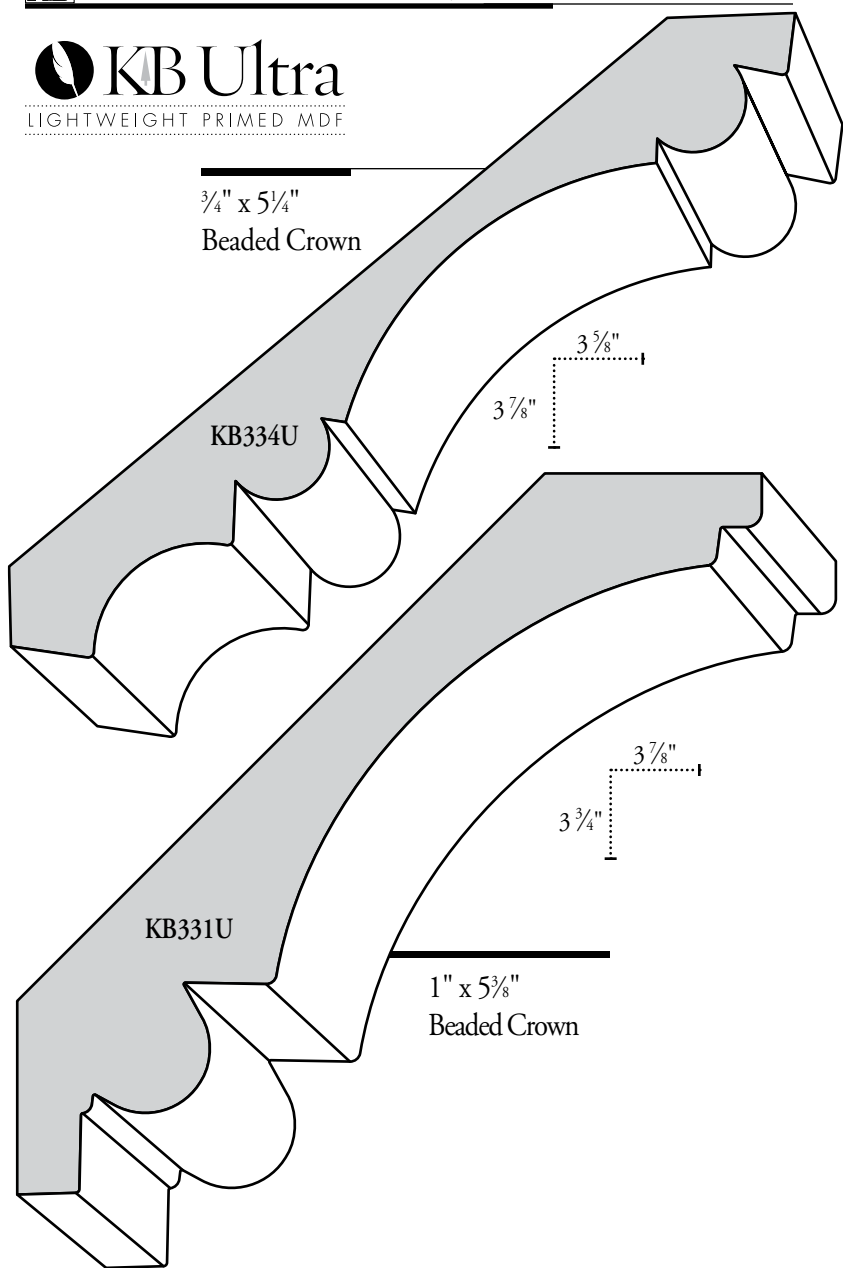

LIGHTWEIGHT PRIMED MDF

the Prestige Line

ULTRA LITE MDF MOULDINGS

The Prestige Line strikes a balance between beauty and cost. These Ultra Lite MDF mouldings are large, (so large we couldn't show all of them at full size) decorative pre-primed white, suitable for finish painting. While we do not stock this line, these profiles are readily available and have a short lead time.



the Prestige Line

ULTRA LITE MDF MOULDINGS

ALL PROFILES SHOWN AT 20%

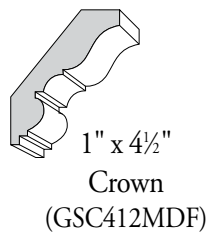
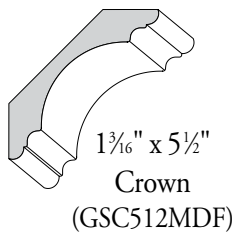
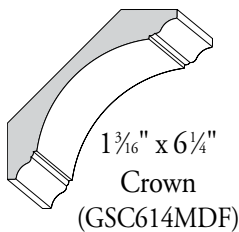
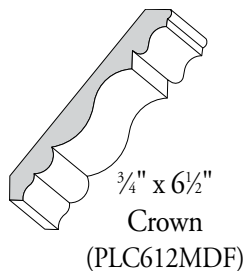
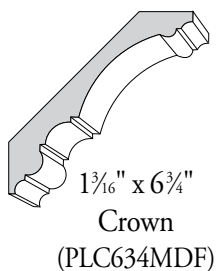
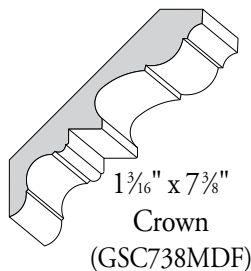
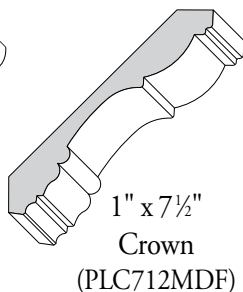
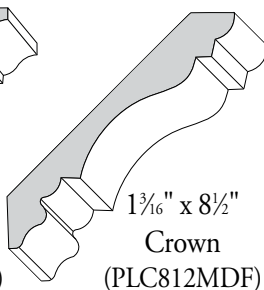
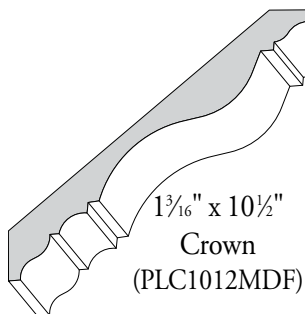

the
Prestige Line

ULTRA LITE MDF MOULDINGS



1" x 3"
Chair Rail
(ES7MDF)



1³/₁₆" x 3³/₄"
Chair Rail
(PLR334MDF)

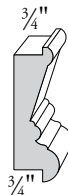

1³/₁₆" x 3¹/₂"
Panel
(PLP312MDF)

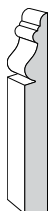

5/8" x 5¹/₄"
Base
(PLB8416MDF)



3/4" x 5³/₄"
Base
(GSB534MDF)



3/4" x 6¹/₂"
Base
(PLB612MDF)



3/4" x 7"
Base
(BB7MDF)



5/8" x 7¹/₄"
Base
(PLB714MDF)

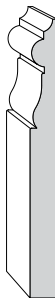

3/4" x 7¹/₄"
Base
(GSB725MDF)

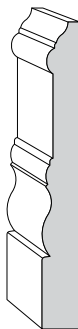

1" x 8"
Base
(PLB8MDF)

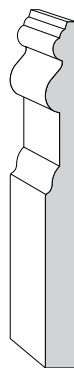

3/4" x 9"
Base
(PLB9MDF)

the
Prestige Line

ULTRA LITE MDF MOULDINGS

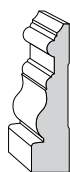

1" x 3 7/8"

Casing

(PL378MDF)

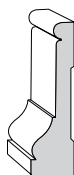

1 1/8" x 4"

Casing

(LK4MDF)



1 1/8" x 4 1/4"

Casing

(GS441MDF)

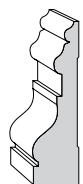

1 3/16" x 4 1/4"

Casing

(GS425MDF)

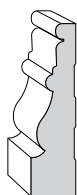

1 1/16" x 4 1/2"

Casing

(GS419MDF)

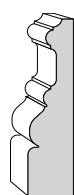

1 3/16" x 4 5/8"

Casing

(PL458MDF)

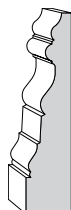

1 3/16" x 5 1/4"

Casing

(PL514MDF)



7/8" x 1 3/4"

Base Cap

(BS134MDF)



GS412 Crown with
CB312 Crown Backer

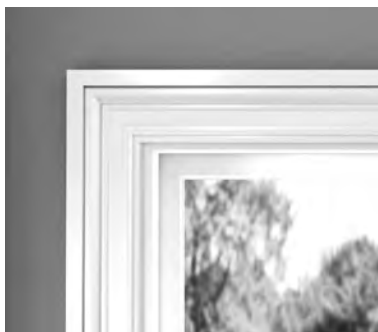

GS434 Casing

EXTERIOR TRIM



PVC Crown

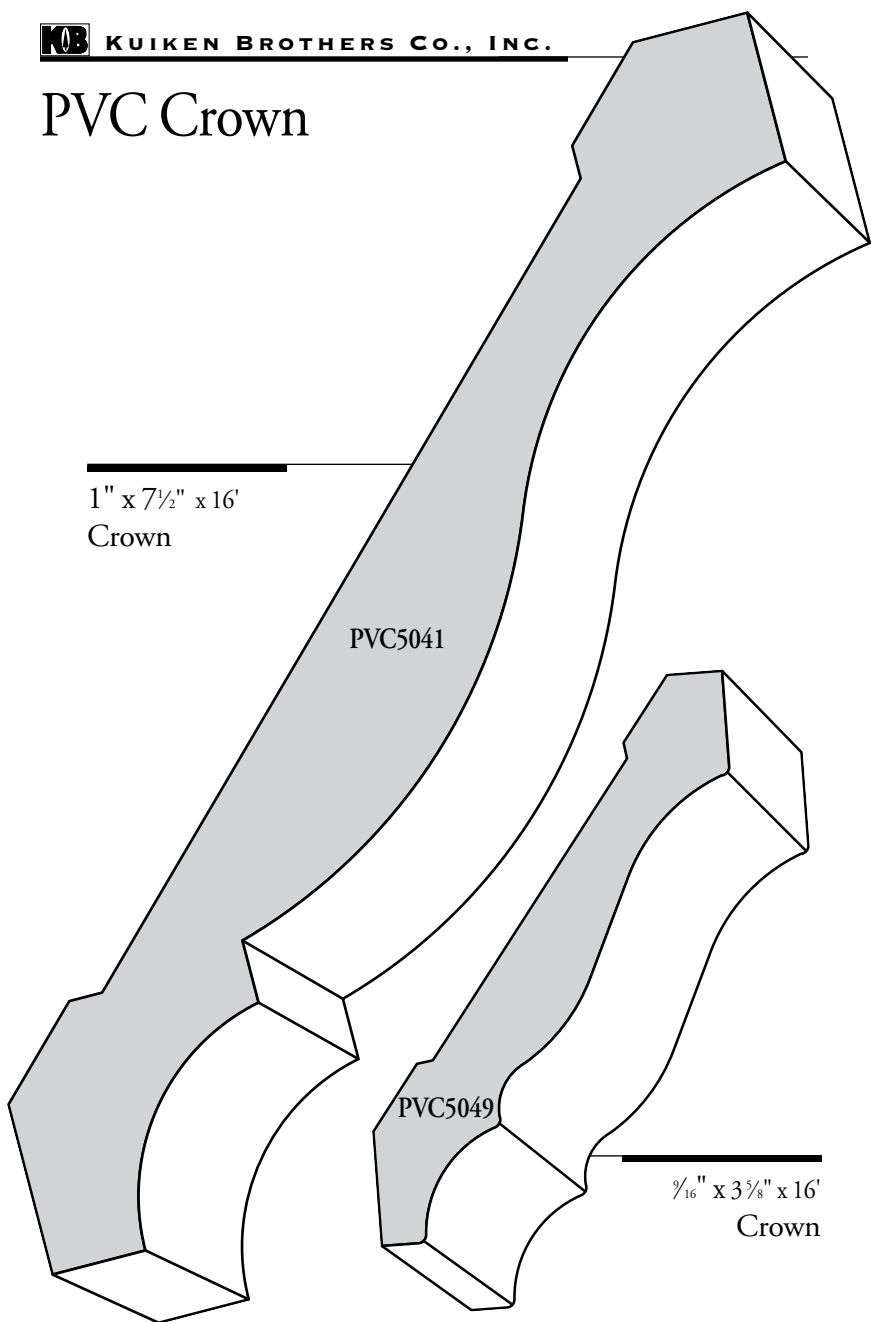

PVC Crown

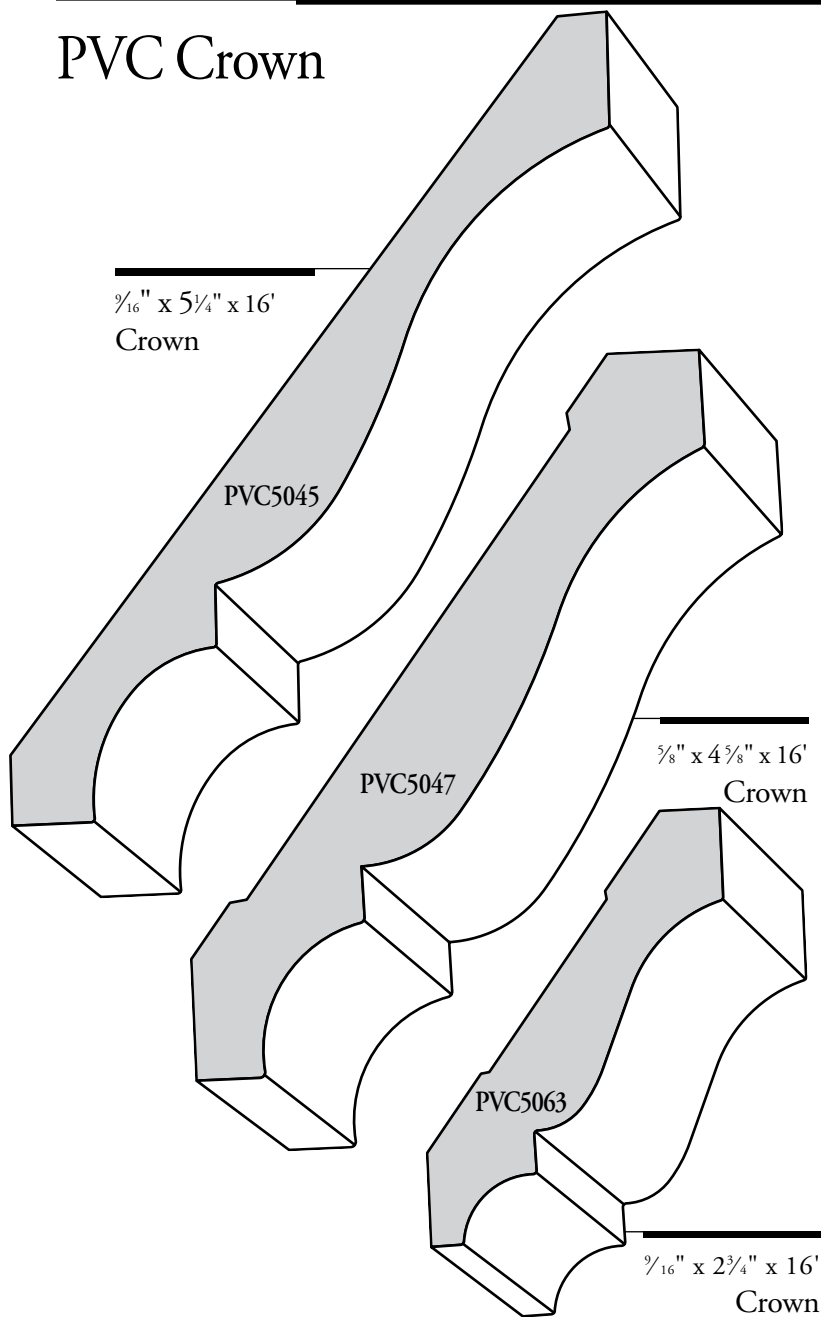

PVC Crown

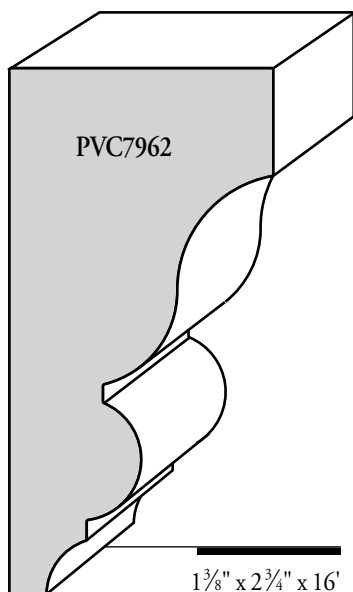

Imperial Rake

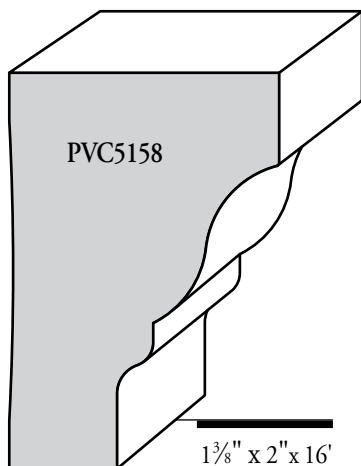

Rams Crown

PVC Shingle Band

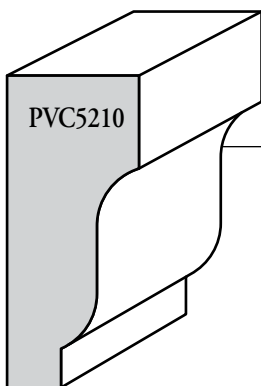

Shingle Band

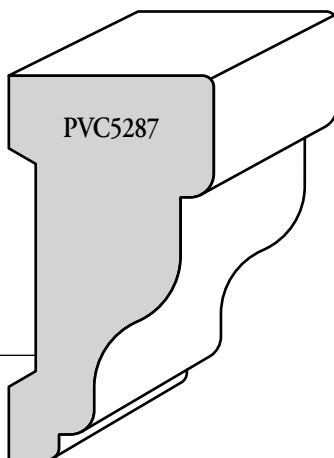

Rake

PVC Bed

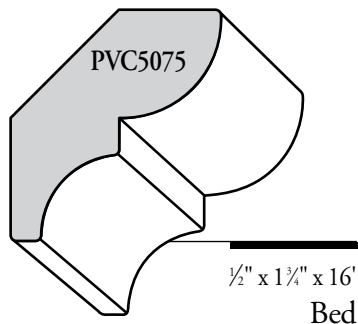

PVC Cove

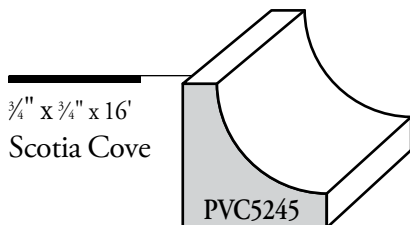

PVC Baluster

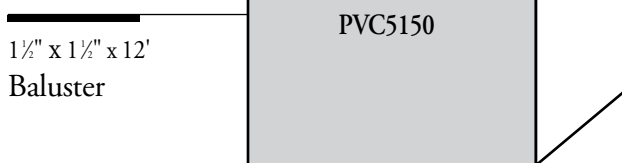

PVC Band Profile

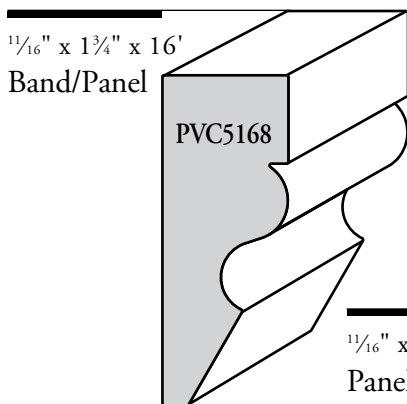

PVC Base Cap

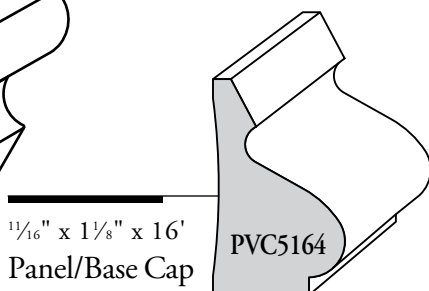

PVC Brick

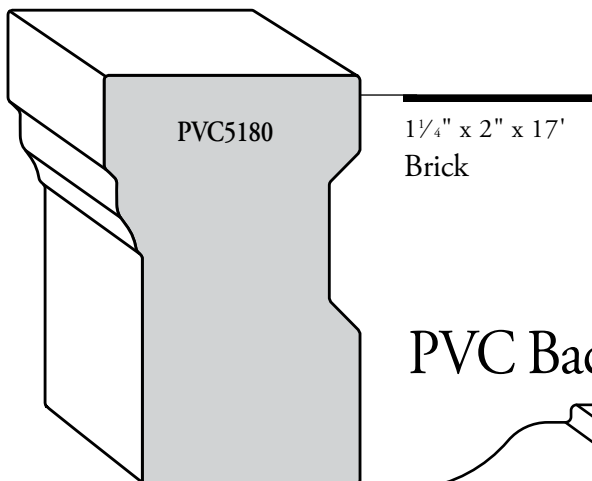

PVC Back Band

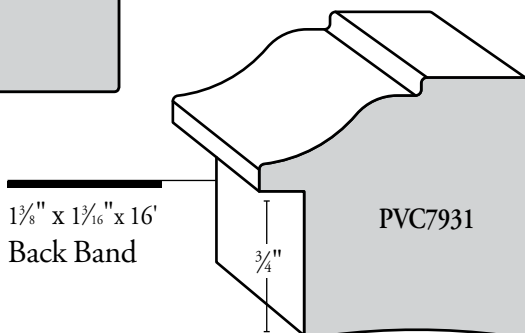

PVC Drip Cap

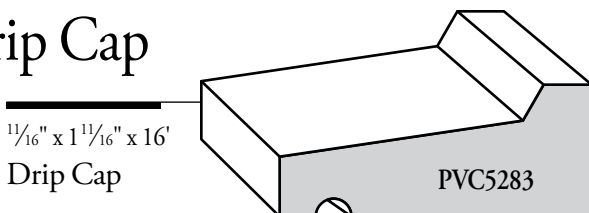

PVC Quarter Round

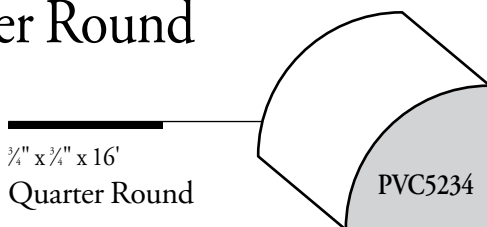

PVC Wainscot Paneling

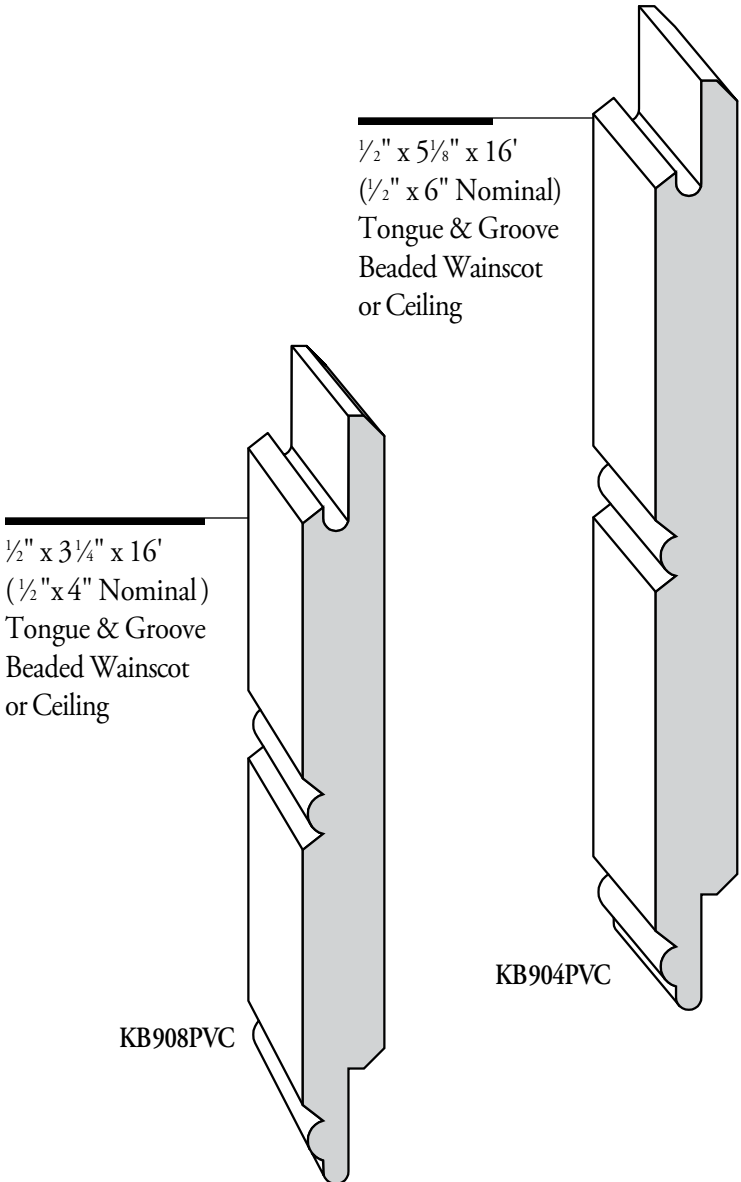

PVC Sill Nosing

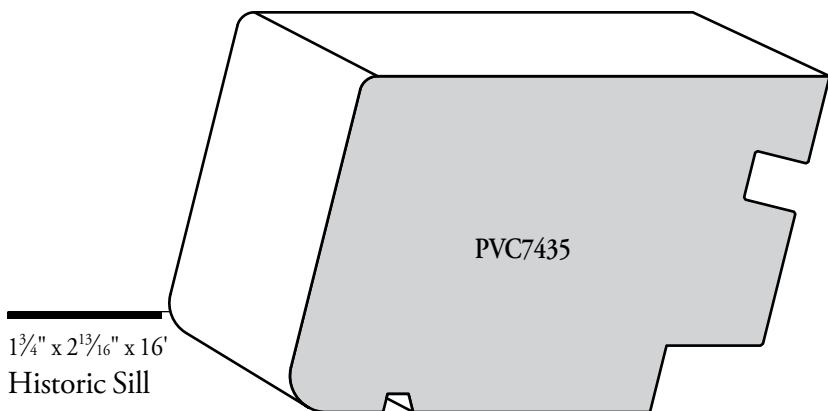

$1\frac{3}{4}'' \times 2\frac{13}{16}'' \times 16'$
Historic Sill

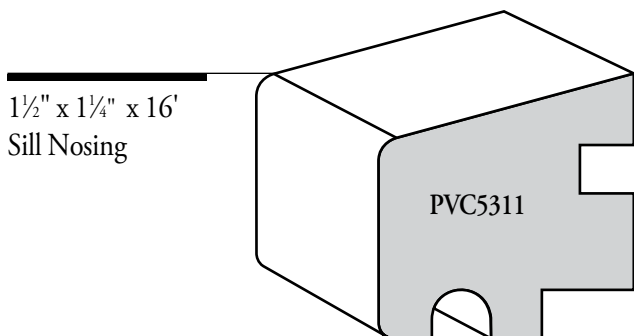

$1\frac{1}{2}'' \times 1\frac{1}{4}'' \times 16'$
Sill Nosing

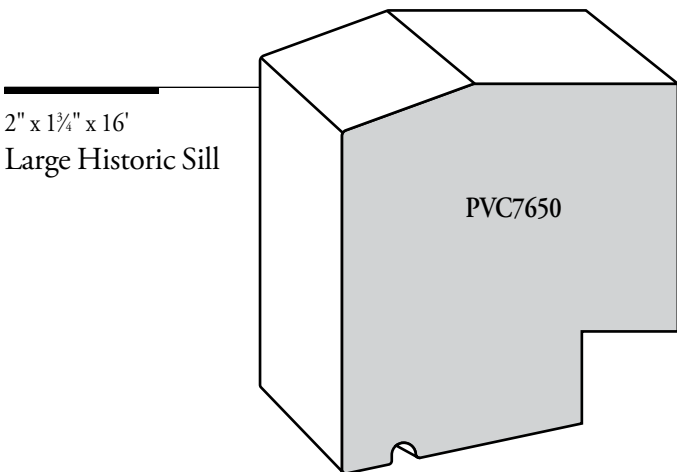

$2'' \times 1\frac{3}{4}'' \times 16'$
Large Historic Sill

PVC Replacement Sill

1 1/4" x 7 1/4" x 10'
Replacement Sill

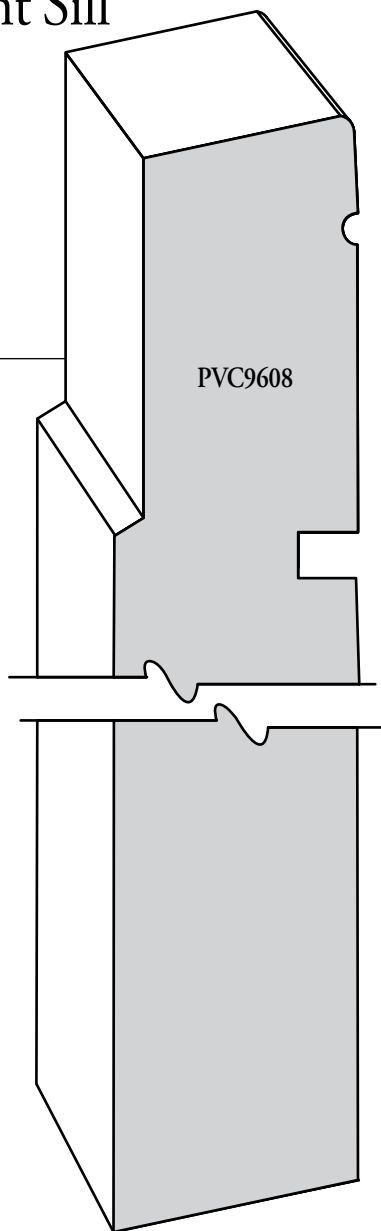

KLEER™ PVC KLEER TRUEDGE

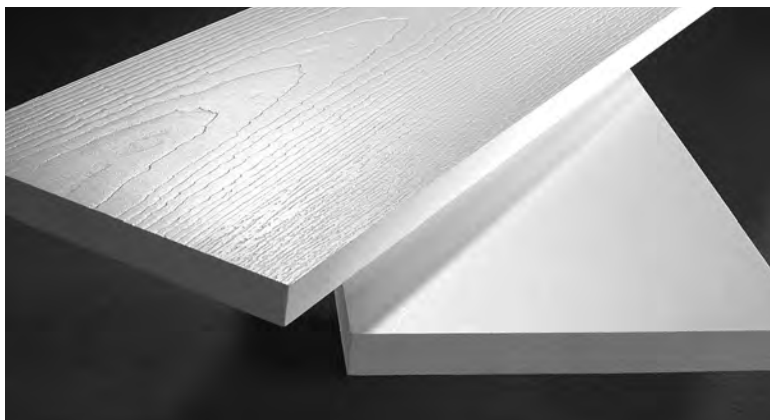

Kuiken Brothers entire inventory of Klear PVC Trimboards feature their innovative TruEDGE technology, a sealed edge which provides sharper cleaner edges that resist dust and dirt.

COLLATED CORTEX HIDDEN FASTENING FOR KLEER PVC TRIM



The Cortex Hidden Fastening System is the fastest, easiest way to hide fasteners in Klear PVC Trim Boards. No more caulking, sanding or painting PVC trim! Available in a collated strip, minimizing handling, saving time on install.

KLEERWrap™

CELLULAR PVC POST WRAP

The easiest, fastest, most cost effective way to improve the appearance and durability of exterior posts. Backed by a lifetime warranty against splintering, rotting, delaminating or excessive swelling.

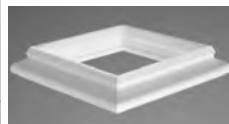
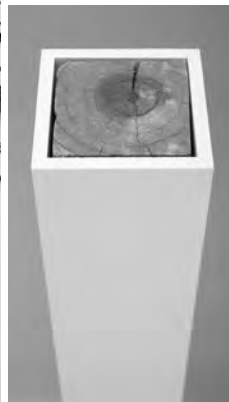
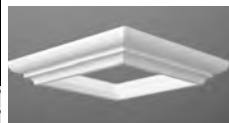

Manufactured from Klear cellular PVC, KLEERWrap Post Wraps create the finished look of natural wood while being virtually impervious to moisture and insects. They are also backed by an industry-leading lifetime warranty against splintering, rotting, delaminating or swelling excessively due to moisture.

Each KlearWrap Post Wrap comes complete with a bed moulding set included. Additional moulding styles sold separately. **Learn more at www.KlearLumber.com**

KLEERWrap Post Wrap

4" x 4" x 8'

4" x 4" x 10'

6" x 6" x 8'

6" x 6" x 10'

IN STOCK

Pre-fabricated PVC Exterior Surrounds

Kuiken Brothers can provide you with custom pre-fabricated PVC exterior surrounds using any of the interior or exterior moulding profiles found in this catalog. Please contact your Kuiken Brothers sales representative for more information.

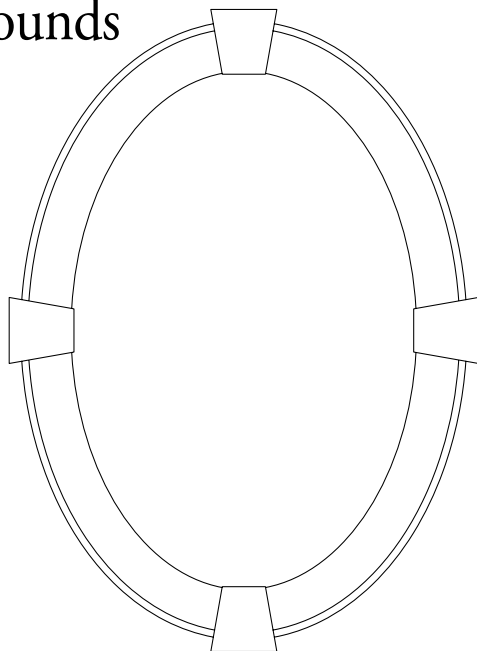

In-Stock PVC Boards & Panels

KLEER Trim	KLEER Panels	KLEER Tongue & Groove Wainscot
<i>(Reversible)</i> 18' lengths Nominal Sizes Listed	<i>(Reversible)</i> 4' x 8' x 1/4" 4' x 8' x 3/8" 4' x 8' x 1/2" 4' x 10' x 1/2" 4' x 8' x 3/4" 4' x 10' x 3/4" 4' x 10' x 1"	<i>(Smooth Only)</i> 1/2" x 4" x 16' 1/2" x 6" x 16'
1" x 4" 5/4" x 4"		KLEER Preformed Corners
1" x 6" 5/4" x 6"		
1" x 8" 5/4" x 8"		<i>(Smooth or Woodgrain)</i>
1" x 10" 5/4" x 10"		5/4" x 4" - 20'
1" x 12" 5/4" x 12"		5/4" x 6" - 20'
	KLEER Beaded Panel 4' x 8' x 1/2"	

PATTERN & STOCK
BOARDS



Shiplap & Wainscot

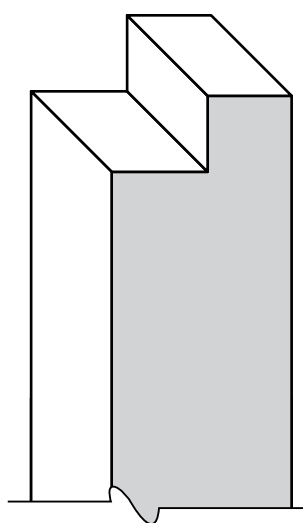

$\frac{7}{8}$ " x $11\frac{1}{4}$ "
(1" x 12"
Nominal)
KB930

■
(Also comes
square edge)

Shiplap
Barn Board

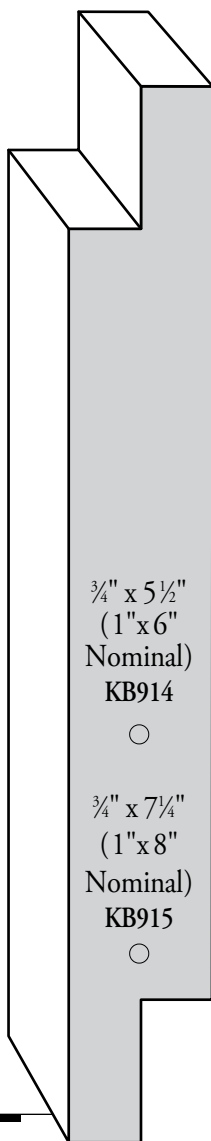

$\frac{3}{4}$ " x $5\frac{1}{2}$ "
(1" x 6"
Nominal)
KB914

$\frac{3}{4}$ " x $7\frac{1}{4}$ "
(1" x 8"
Nominal)
KB915

Shiplap

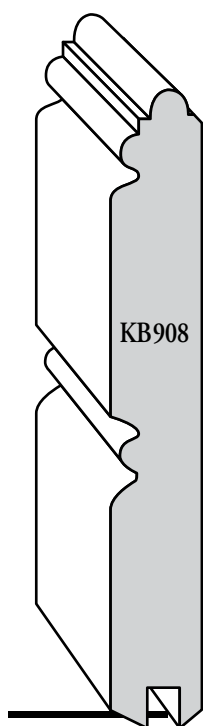

KB908

$\frac{7}{16}$ " x $3\frac{1}{4}$ "
($\frac{1}{2}$ " x 4" Nominal)
Tongue & Groove
Beaded Wainscot
or Ceiling

□ ○

For Kleer PVC Options,
see page 151

Wainscot & Paneling

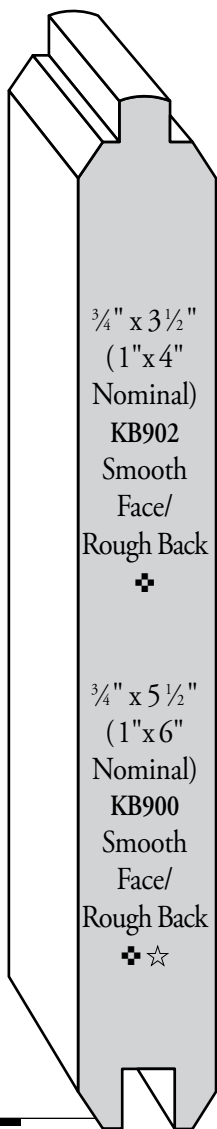

$\frac{3}{4}$ " x $3\frac{1}{2}$ "
(1"x4"
Nominal)
KB902
Smooth
Face/
Rough Back



$\frac{3}{4}$ " x $5\frac{1}{2}$ "
(1"x6"
Nominal)
KB900
Smooth
Face/
Rough Back



Reversible "V" Joint

Tongue & Groove Paneling

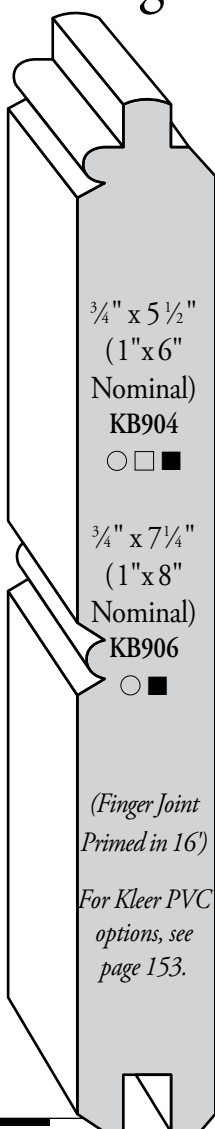

$\frac{3}{4}$ " x $5\frac{1}{2}$ "
(1"x6"
Nominal)
KB904



$\frac{3}{4}$ " x $7\frac{1}{4}$ "
(1"x8"
Nominal)
KB906



*(Finger Joint
Primed in 16')*

*For Kleer PVC
options, see
page 153.*

Reversible Tongue & Groove

Paneling/Beaded Ceiling

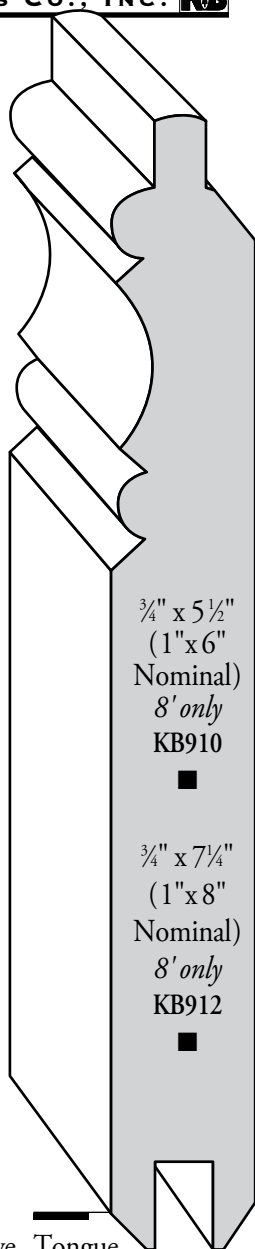

$\frac{3}{4}$ " x $5\frac{1}{2}$ "
(1"x6"
Nominal)
8' only
KB910



$\frac{3}{4}$ " x $7\frac{1}{4}$ "
(1"x8"
Nominal)
8' only
KB912



Tongue

& Groove Paneling

○ Primed FJ Pine

■ Knotty Pine

□ Clear Yellow Pine

⊕ A&BTR Cedar

☆ Knotty Cedar



Plywood Beadboard

Available in 48" x 96"

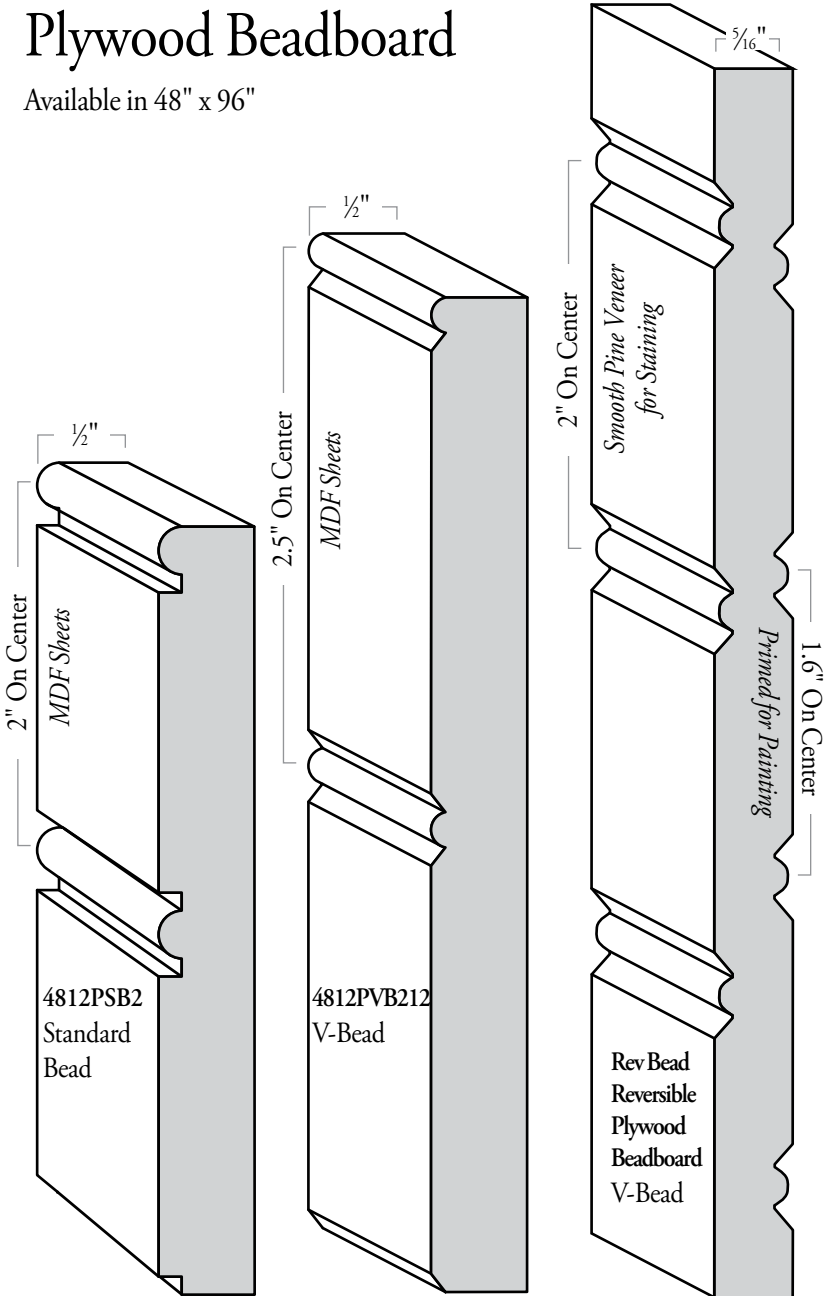

Beadboard, Wainscot Cap

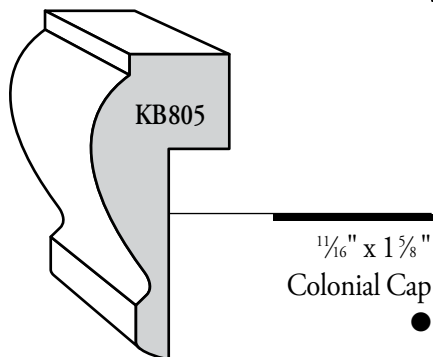
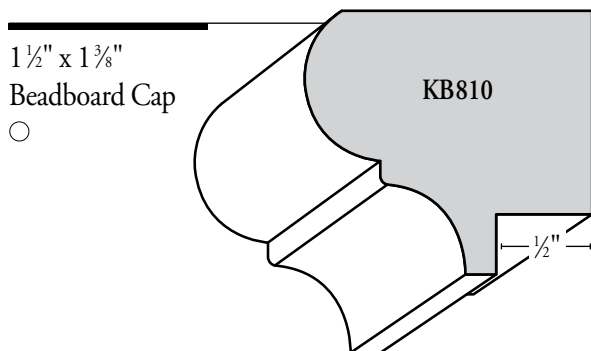
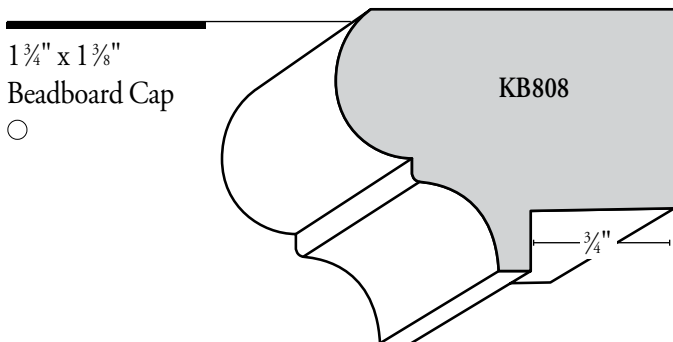

● Clear Pine

○ Primed FJ Pine

▲ Primed FJ Poplar

🍃 Lightweight Primed MDF

Siding

Many sidings are available with factory priming or pre-finished (special order only)

Novelty Siding

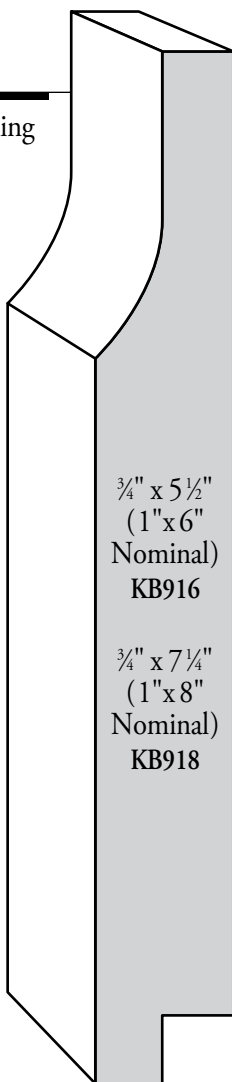

$\frac{3}{4}$ " x $5\frac{1}{2}$ "
(1" x 6" Nominal)
KB916

$\frac{3}{4}$ " x $7\frac{1}{4}$ "
(1" x 8" Nominal)
KB918

$\frac{1}{2}$ " x $5\frac{1}{2}$ "
($\frac{1}{2}$ " x 6" Nominal)
Bevel Cedar
Siding

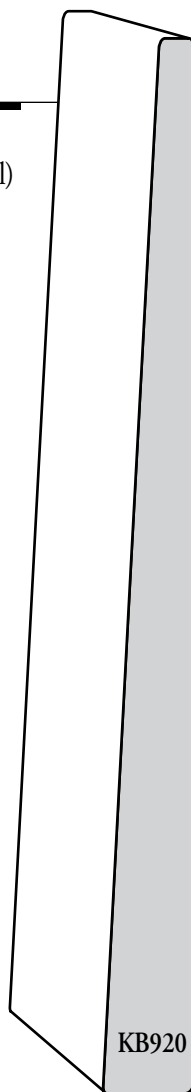

KB920



Siding

$\frac{1}{2}$ " x $7\frac{1}{4}$ "
 ($\frac{1}{2}$ " x 8"
 Nominal)
 Bevel Cedar
 Siding
 ★ +

$\frac{3}{4}$ " x $9\frac{1}{4}$ "
 ($\frac{3}{4}$ " x 10"
 Nominal)
 Bevel
 Cedar
 Siding
 ★ +

Skirl
 Wavy Edge Siding
 $\frac{7}{8}$ " x $9\frac{1}{2}$ " - $11\frac{1}{2}$ "
 ($\frac{7}{8}$ " x 10" - 12"
 Nominal)
 ☆

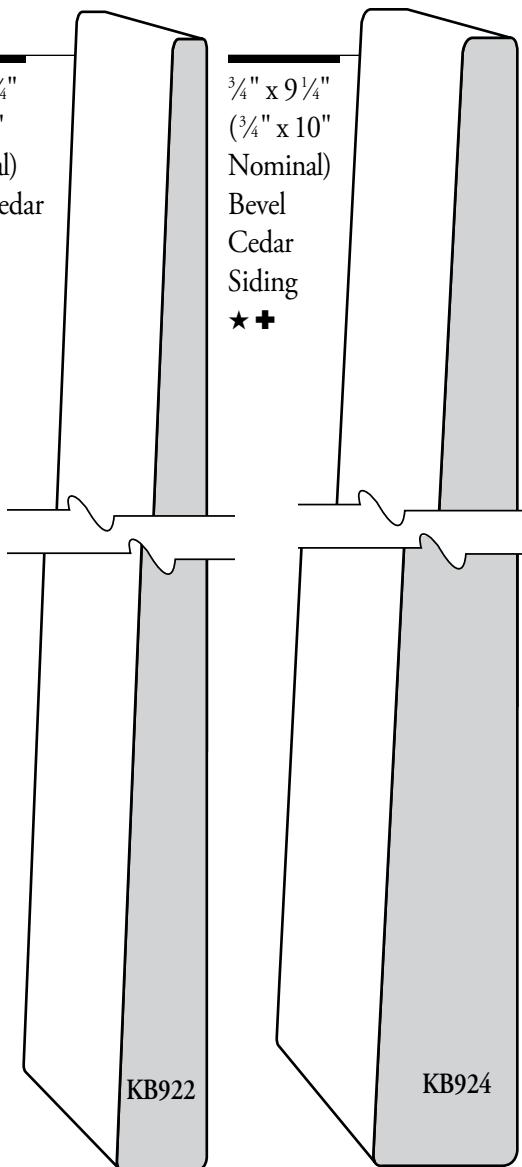

KB922

KB924

<p>■ Knotty Pine</p>	<p>□ Southern Yellow Pine</p>	<p>★ Clear Cedar</p>	<p>☆ Knotty Cedar</p>	<p>+ Finger Joint & Primed</p>
----------------------	-------------------------------	----------------------	-----------------------	------------------------------------

Siding

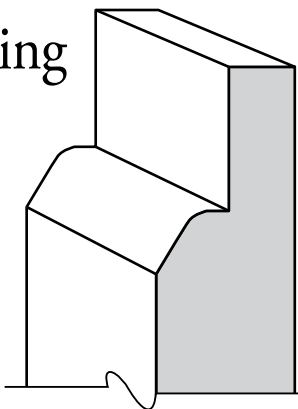

1½" x 7⅞"
(2" x 8"
Nominal)
Log Cabin
Siding



Channel
Groove
Rustic
Siding

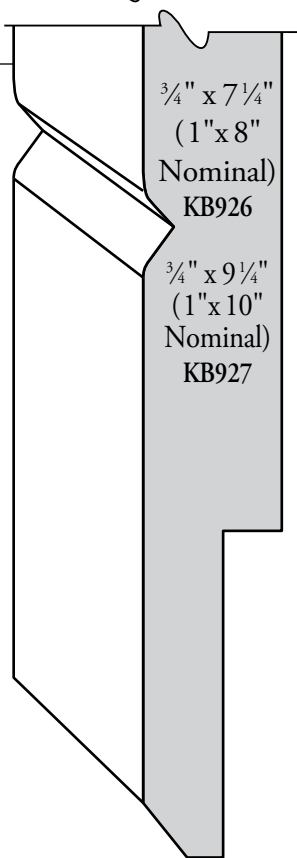

¾" x 7¼"
(1" x 8"
Nominal)
KB926

¾" x 9¼"
(1" x 10"
Nominal)
KB927

KB928

■ Knotty Pine

□ Southern Yellow Pine

★ Clear Cedar

☆ Knotty Cedar

Siding & Roof Deck

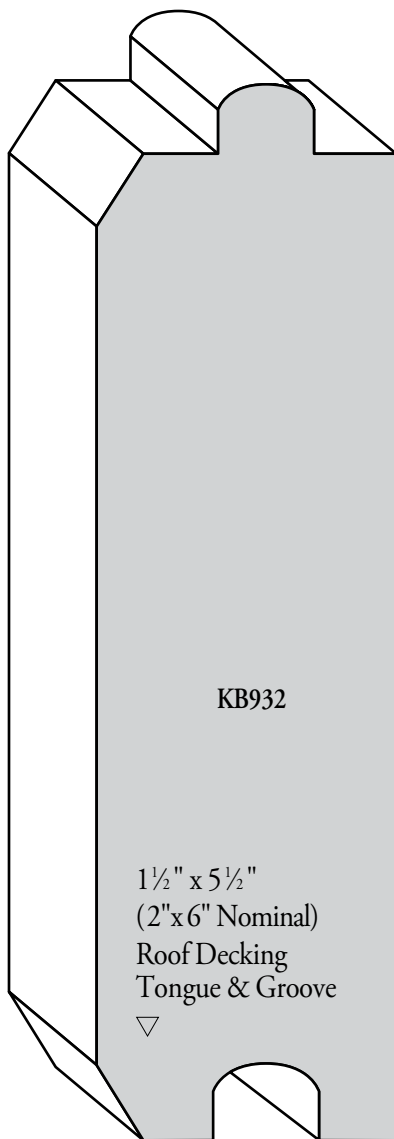

■ Knotty Pine	□ Southern Yellow Pine	★ Clear Cedar	▽ Std & Btr. Spruce	+ Finger Joint & Primed
---------------	------------------------	---------------	---------------------	-------------------------

Flooring

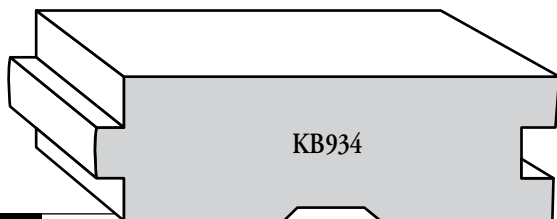

$\frac{3}{4}$ " x $2\frac{1}{4}$ " (1" x 3" Nominal)
Tongue & Groove Yellow Pine
Flooring

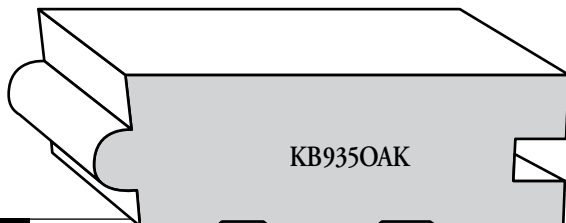

$\frac{3}{4}$ " x $2\frac{1}{4}$ " (1" x 3" Nominal)
Tongue & Groove Oak Flooring



- Select Red
- #1 Common Red

(other species and grades are available on request)

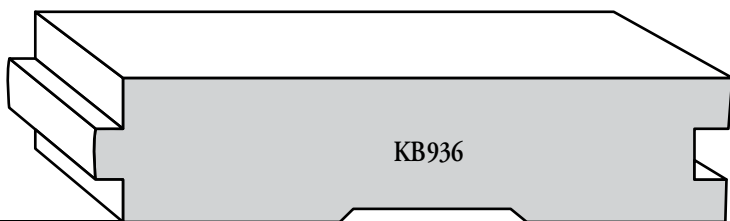

$\frac{3}{4}$ " x $3\frac{1}{2}$ " (1" x 4" Nominal) Tongue & Groove Flooring



Flooring & Stepping

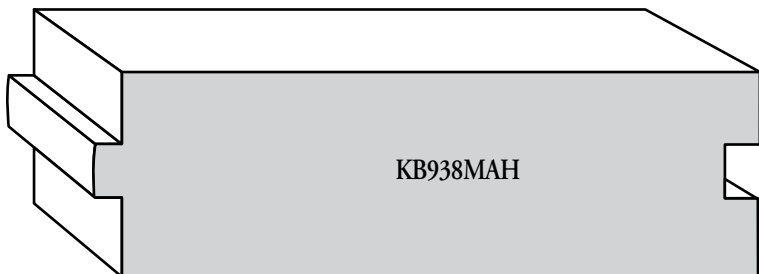

KB938MAH

1 1/16" x 3 1/2" (5/4" x 4" Nominal)

Tongue & Groove Flooring

◆ (Meranti)

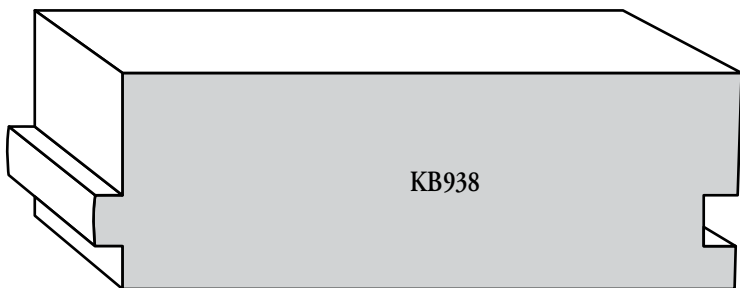

KB938

1 1/16" x 3 1/2" (5/4" x 4" Nominal)

Tongue & Groove Flooring

❖ ❖

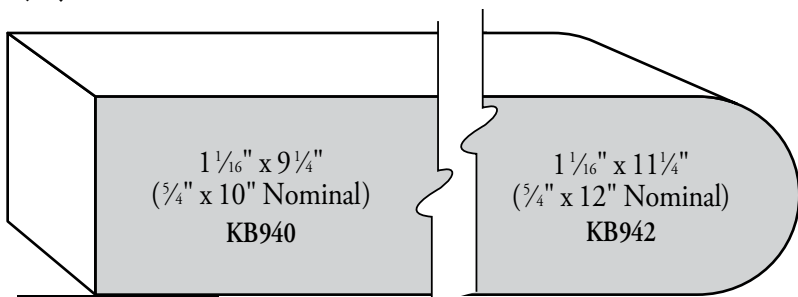

1 1/16" x 9 1/4"
(5/4" x 10" Nominal)
KB940

1 1/16" x 11 1/4"
(5/4" x 12" Nominal)
KB942

Stepping

□ ❖ ● ▲ (● 5/4" x 10" – 12' Only) (▲ 5/4" x 12" – 4' or 6' Only)

● CCA Treated	□ Clear Yellow Pine	❖ Clear Fir	❖ Finger Joint Fir	◆ Mahogany	▲ Oak
---------------	---------------------	-------------	--------------------	------------	-------



Standard Board

Nominal Size Stock Chart

Most standard boards are available in clear pine, knotty pine, primed pine, poplar, finger joint poplar, oak, cherry, mahogany, clear cedar and maple. Boards are generally ordered by their nominal size. The following chart depicts the nominal size and actual size.

Nominal Sizes	Actual Sizes	Windsor ONE+ Protected	Kleer PVC	Boral TruExterior	White Pine D & BTR	White Pine C & BTR	White Pine #2 COM	White Pine F/J E/G Decorative	Cherry	Oak, Mahogany, Maple, Poplar
1/2" x 2"	1/2" x 1-1/2"				■					
1/2" x 3"	1/2" x 2-1/2"				■					
1/2" x 4"	1/2" x 3-1/2"				■		■			
1/2" x 6"	1/2" x 5-1/2"				■		■			
1/2" x 8"	1/2" x 7-1/4"				■		■			
1/2" x 10"	1/2" x 9-1/4"				■		■			
1/2" x 12"	1/2" x 11-1/4"				■		■			
1" x 2"	3/4" x 1-1/2"	■				■	■			
1" x 3"	3/4" x 2-1/2"	■				■	■			
1" x 4"	3/4" x 3-1/2"	■	■	■		■	■		■	■
1" x 6"	3/4" x 5-1/2"	■	■	■		■	■		■	■
1" x 8"	3/4" x 7-1/4"	■	■	■		■	■		■	■
1" x 10"	3/4" x 9-1/4"	■	■	■		■	■			■
1" x 12"	3/4" x 11-1/4"	■	■	■		■	■			■
1" x 14"	3/4" x 13-1/4"							■		
1" x 18"	3/4" x 17-1/4"							■		
1" x 24"	3/4" x 23-1/4"							■		
5/4" x 3"	1-1/8" x 2-1/2***	■					■			
5/4" x 4"	1-1/8" x 3-1/2***	■	■	■		■	■			■
5/4" x 6"	1-1/8" x 5-1/2***	■	■	■		■	■			■
5/4" x 8"	1-1/8" x 7-1/4***	■	■	■		■	■			■
5/4" x 10"	1-1/8" x 9-1/4***	■	■	■		■	■			■
5/4" x 12"	1-1/8" x 11-1/4***	■	■	■		■	■			■
8/4" x 12"	1-13/16" x 11-1/4***						■			

*Hardwoods (Cherry, Mahogany, Maple) are FAS Grade **Slight variation between manufacturers may occur

Stock Plywood & Panel Chart

Kuiken Brothers stocks a wide range of plywood and sheet good products for interior & exterior applications, including hardwoods, sanded plywoods, Fiberboard/MDF, shelving, wiggle board and more. The following chart shows our in-stock options. Location may vary, please call in advance.

Size	Type	1/8"	1/4"	3/8"	5/16"	1/2"	5/8"	3/4"	1"	1-1/4"
HARDWOOD PLYWOOD										
4' x 8'	Cherry Plywood							■		
4' x 8'	Oak (Red) Plywood		■			■		■		
4' x 8'	Sapele Mahogany Plywood		■			■		■		
4' x 8'	Maple Plywood		■			■		■		
4' x 8'	Natural Birch Plywood		■			■		■		
4' x 8'	Maple Plywood UV Finished 2 sides					■		■		
4' x 8'	Chinese Birch Plywood					■		■		
4' x 8'	Lauan Plywood	■ (2.7 MM)	■ (5.2 MM)	■		■ (12 MM)		■ (18 MM)		
4' x 8'	RevolutionPly Panel		■ (5.2 MM)							
SANDED PLYWOOD										
4' x 8'	AC Grade Fir Plywood		■	■		■	■	■	■	
4' x 8'	AB Marine Grade Fir Plywood					■		■		
4' x 8'	MDO Plywood					■		■		
FIBERBOARD/ MDF										
4' x 8'	Light Density Fiberboard		■			■		■	■	■
4' x 10'	Light Density Fiberboard							■		
BEADBOARD										
4' x 8'	Primed MDF Standard Beadboard 2" O.C.					■				
4' x 8'	Primed MDF V Beadboard 2-1/2" O.C.					■				
4' x 8'	Pine Plybead Panel 2" O.C.			■						
4' x 8'	ReversibleBead Panel 1.6" O.C. Primed Side			■ (5/16)						
4' x 8'	ReversibleBead Panel 2" O.C. Clear Side			■ (5/16)						
SHELVING										
4' x 8'	White Melamine Good 2 Sides							■		
12" X 96"	White RediShelf							■		
16" x 96"	White RediShelf							■		
4' x 8'	Tempered Hardboard Panel	■	■							
4' x 8'	Tempered Pegboard Panel		■							
PVC (KLEER)										
4' x 8'	Kleer PVC Panel		■	■		■		■		
4' x 10'	Kleer PVC Panel					■		■	■	
4' x 8'	Beaded 2" O.C. Kleer PVC Panel					■				
MISCELLANEOUS										
4' x 8'	Wiggle Board 8' Tube (Column)			■						
8' x 4'	Wiggle Board 4' Tube (Barrel)			■						
4' x 8'	Aromatic Cedar Closet Lining		■							

MOULDING DESIGN GUIDE TO GO!



WWW.KUIKENBROTHERS.COM

DOWNLOAD MANTEL & ROOM MOULDING COMBINATIONS

For even more full room combinations, Visit www.kuikenbrothers.com/mouldingdesignguide to download all of the combinations shown in this catalog. Packages include historic designs from the Classical Moulding Collection as well as Craftsman and Colonial style packages designed with our traditional profiles. Available in PDF, DXF and DWG file types. Plus, these designs can easily be downloaded to your laptop or mobile device for jobsite client consultations.

MOULDING DESIGN GUIDE

The following pages feature full room moulding, mantel, coffered ceiling and door header combinations built with profiles from our in-stock moulding to help simplify the selection process. Choosing a crown moulding can be simple, but finding matching base and casings can be difficult and sometimes overwhelming.

To download complete CAD file blocks of these room and mantel combination details and to easily incorporate into your architectural details visit kuikenbrothers.com/mouldingdesignguide





MOULDING DESIGN GUIDE
EARLY AMERICAN OFFICE

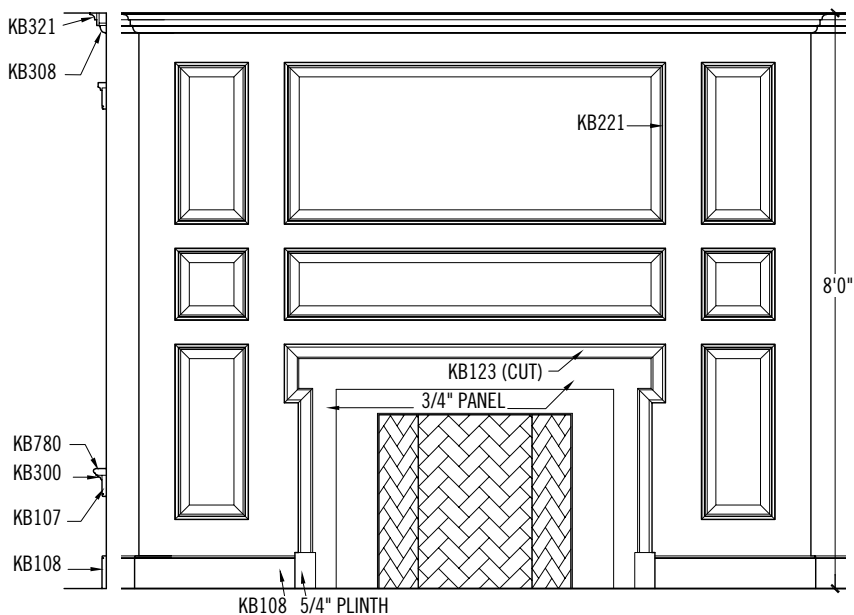

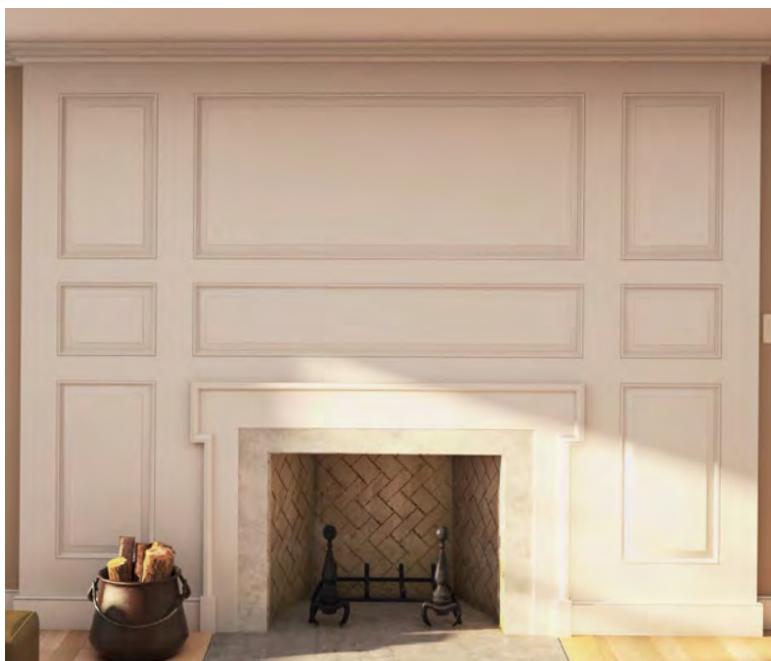



MOULDING DESIGN GUIDE
GEORGIAN TOWNHOUSE

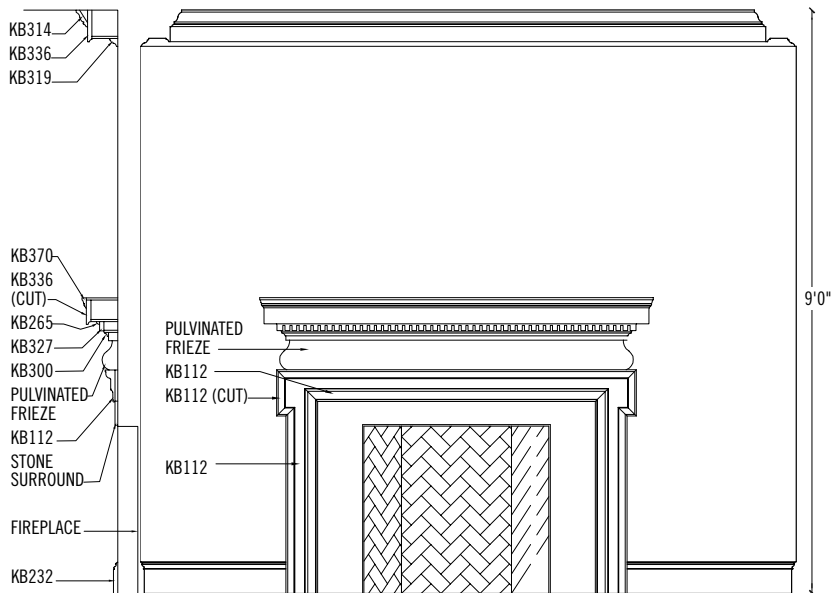





MOULDING DESIGN GUIDE
**MODERN CRAFTSMAN ARTS
 & CRAFTS LIVING ROOM**

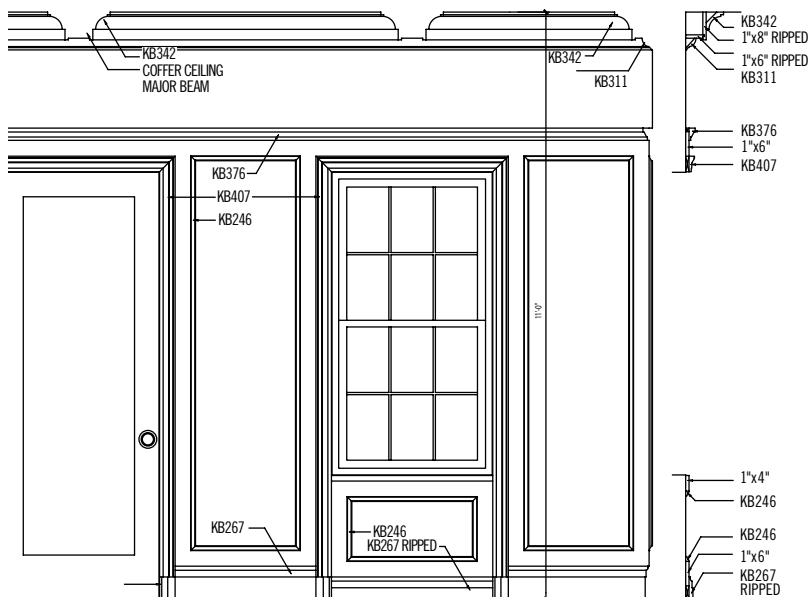





MOULDING DESIGN GUIDE
GREEK REVIVAL FARM HOUSE

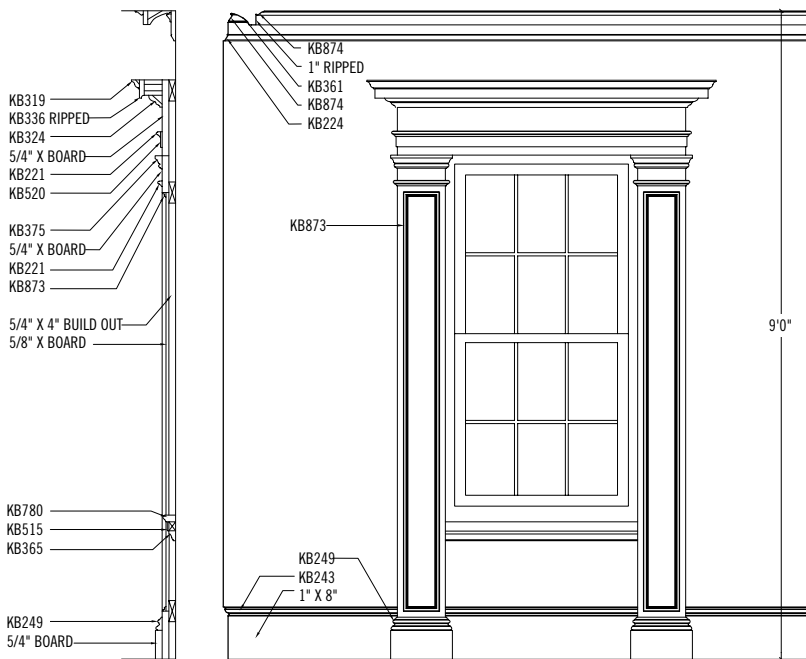





MOULDING DESIGN GUIDE
MODERN CRAFTSMAN JUDGES PANEL

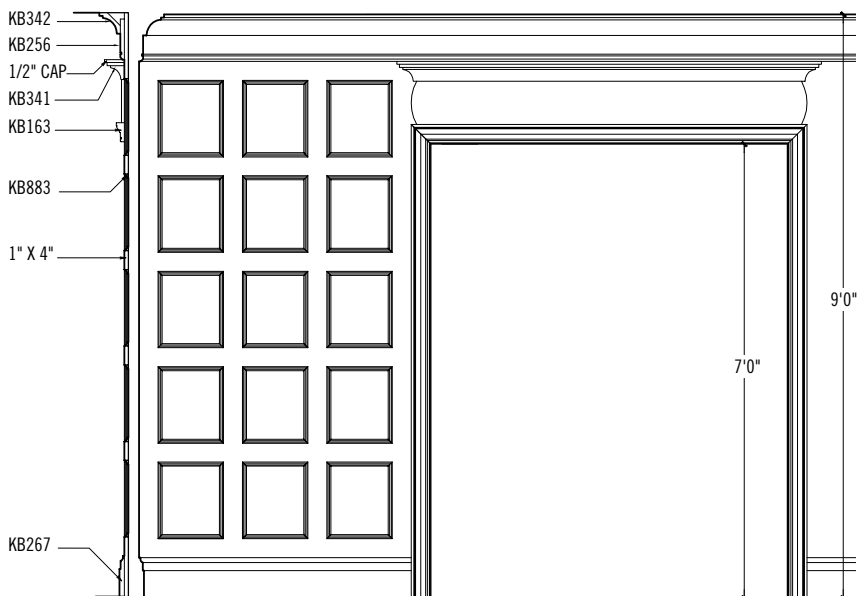





MOULDING DESIGN GUIDE
ARTS & CRAFTS
COFFERED CEILING

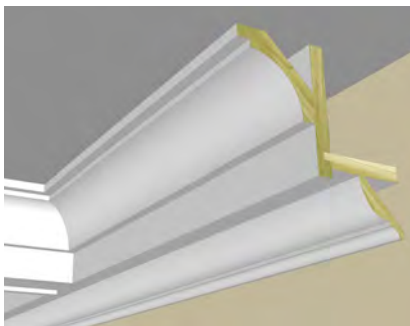
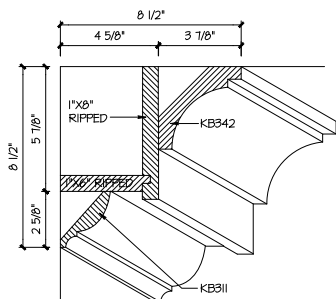
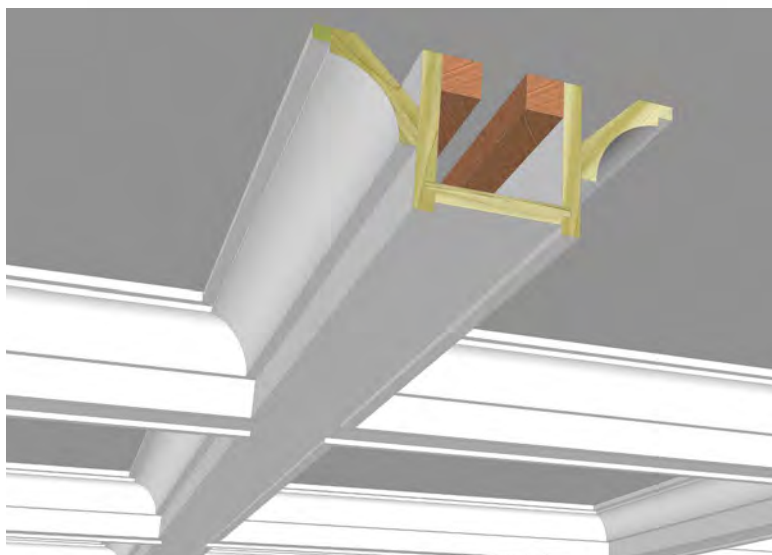
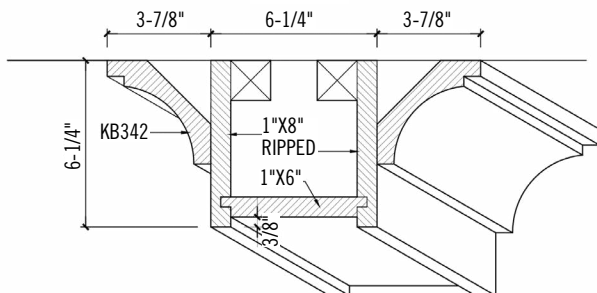



MOULDING DESIGN GUIDE
COFFERED CEILING #10

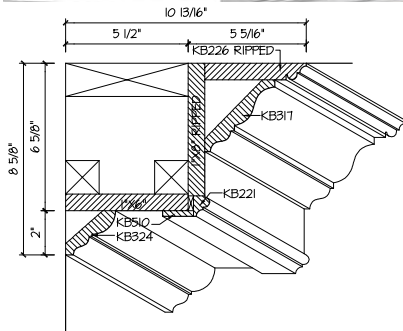
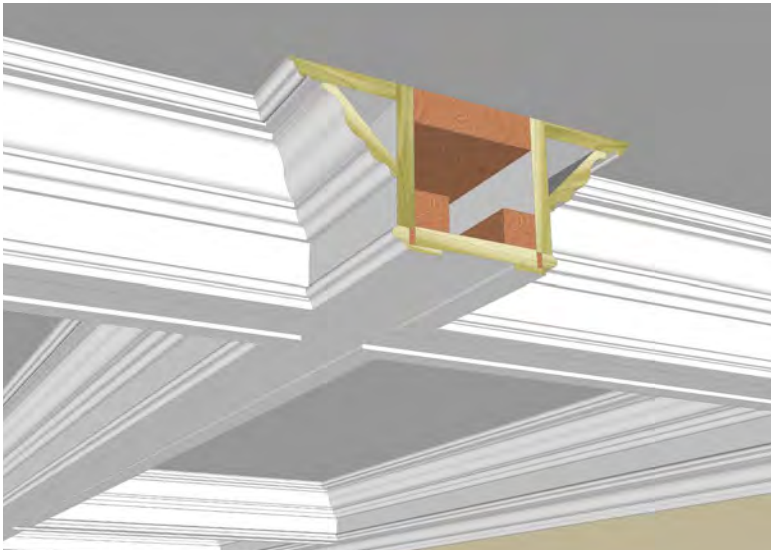
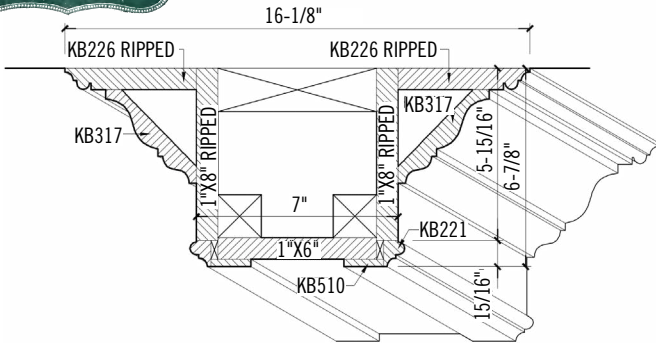



MOULDING DESIGN GUIDE SIMPLE SHAKER STYLE COFFERED CEILING

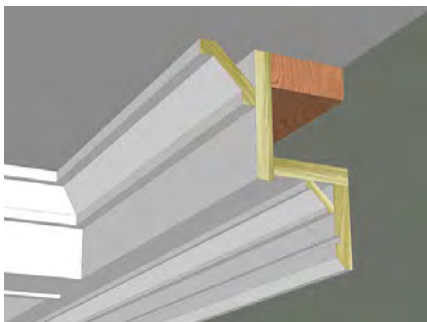
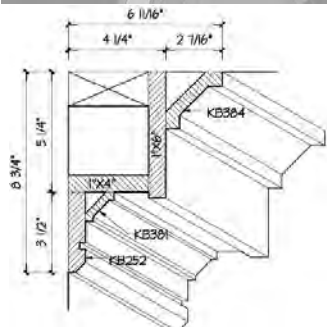
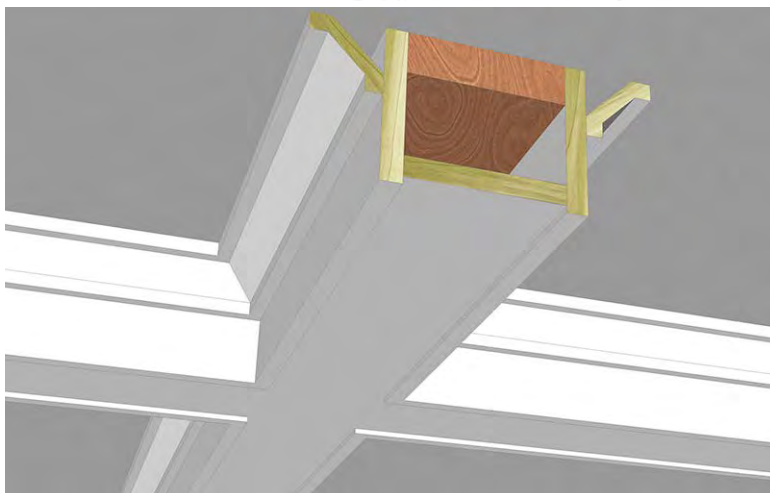
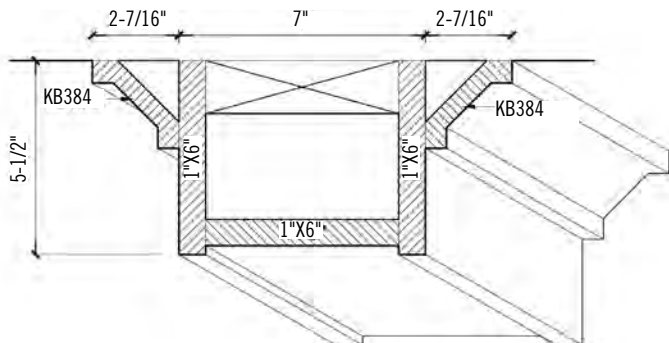



MOULDING DESIGN GUIDE
SHAKER CAP & BEAD ROOM

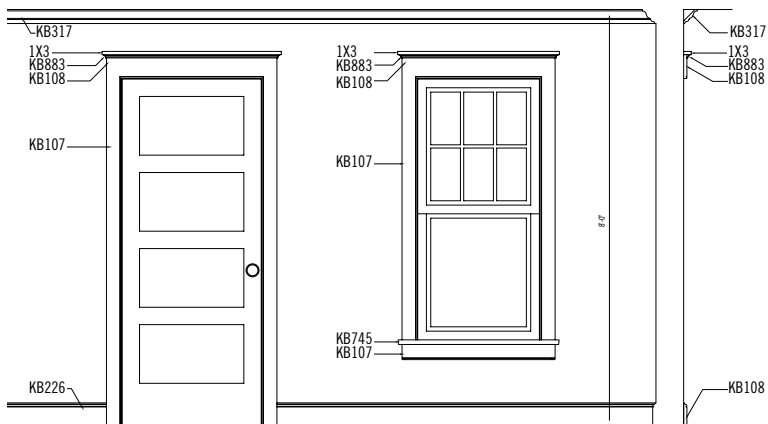



MOULDING DESIGN GUIDE
PANEL BULL ROOM

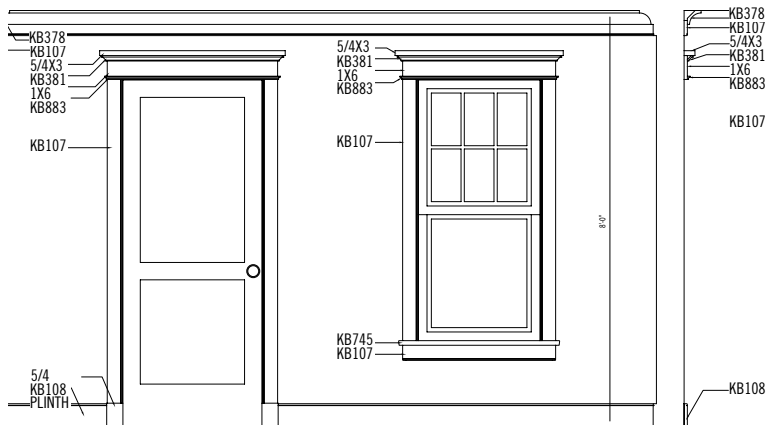



MOULDING DESIGN GUIDE
SIMPLE SOLID CROWN ROOM

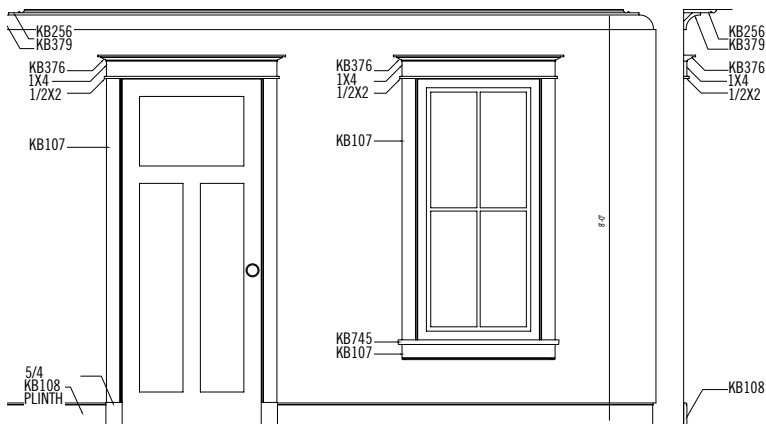



MOULDING DESIGN GUIDE
FEDERAL MANTEL

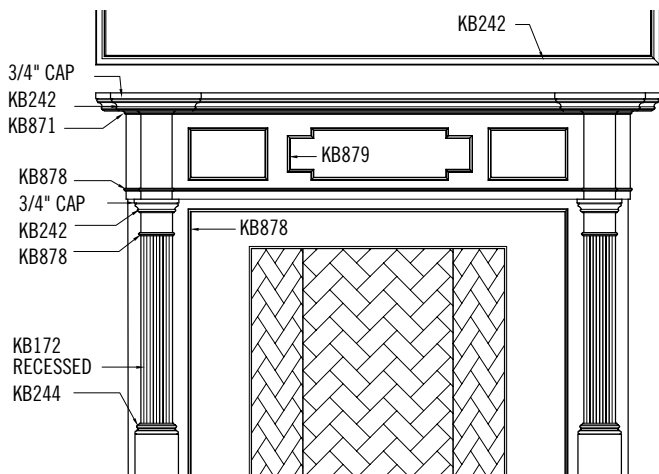



MOULDING DESIGN GUIDE
GEORGIAN MANTEL

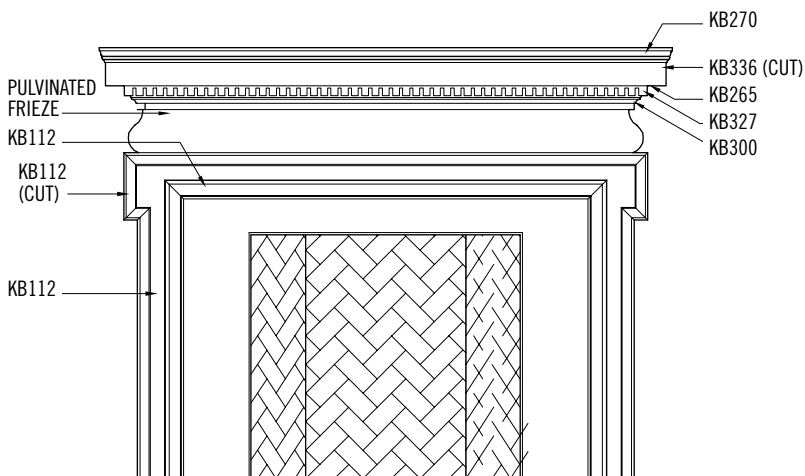



MOULDING DESIGN GUIDE
GREEK REVIVAL MANTEL

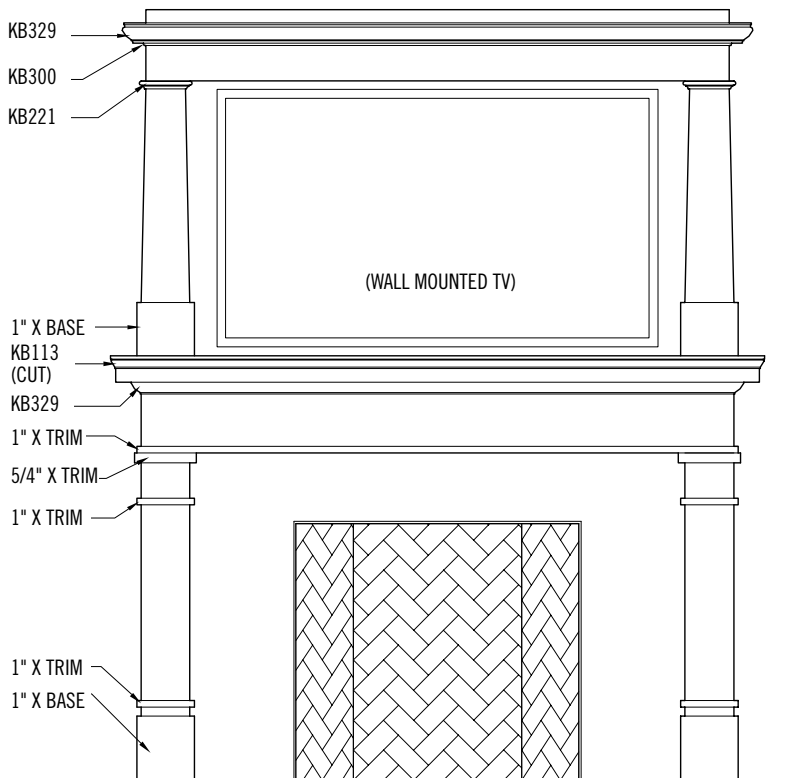





MOULDING DESIGN GUIDE
COLONIAL REVIVAL MANTEL

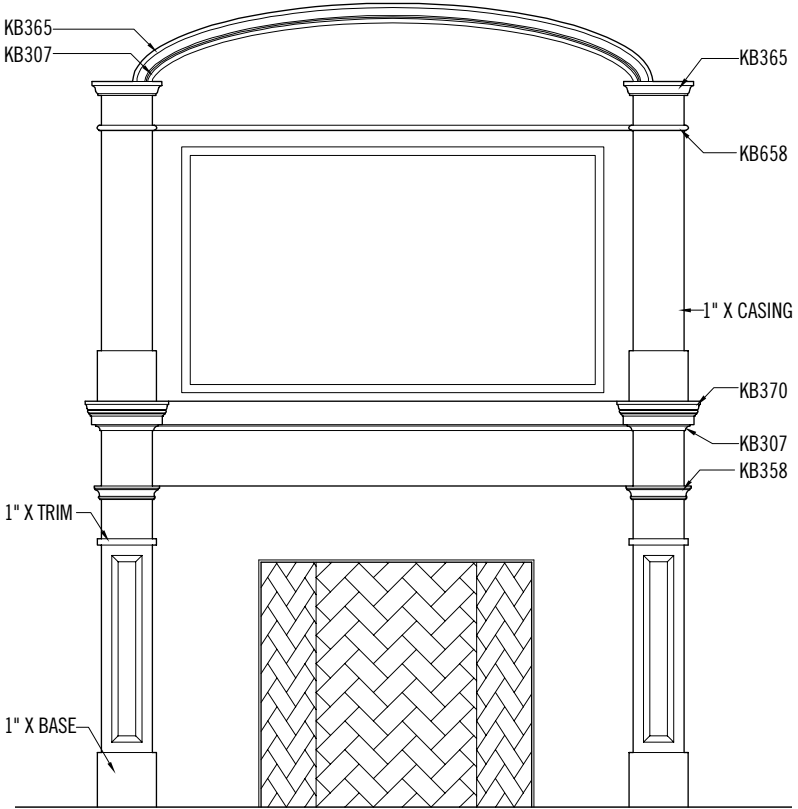





MOULDING DESIGN GUIDE
PALLADIAN WINDOW

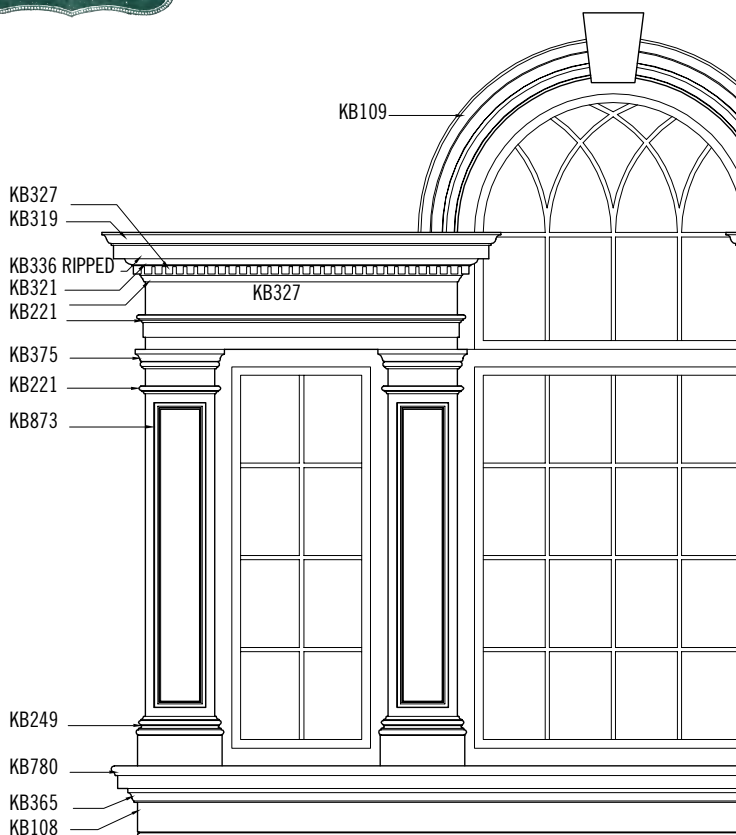

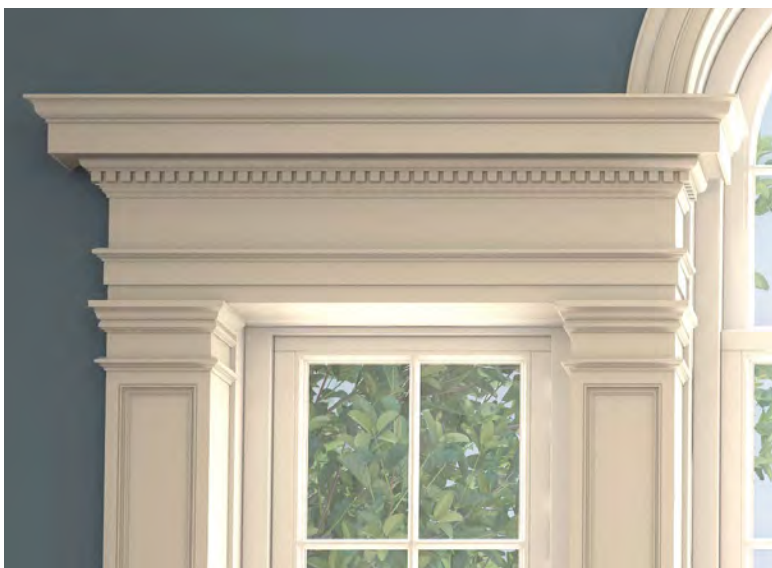



MOULDING DESIGN GUIDE
**MODERN CRAFTSMAN
LAKE HOUSE KITCHEN**

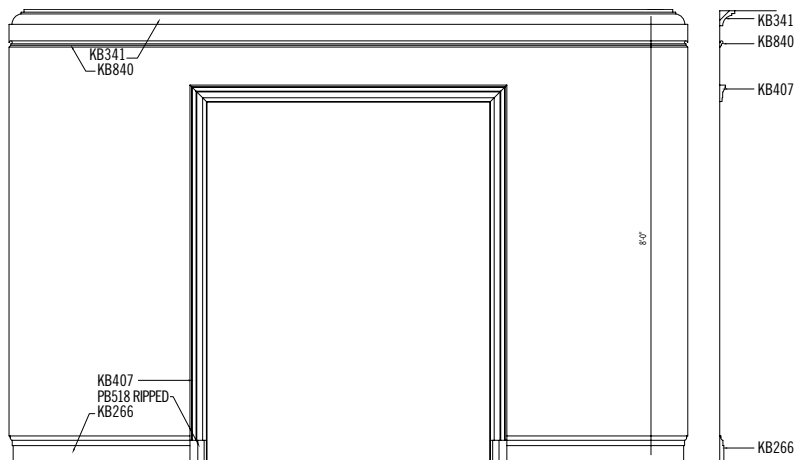

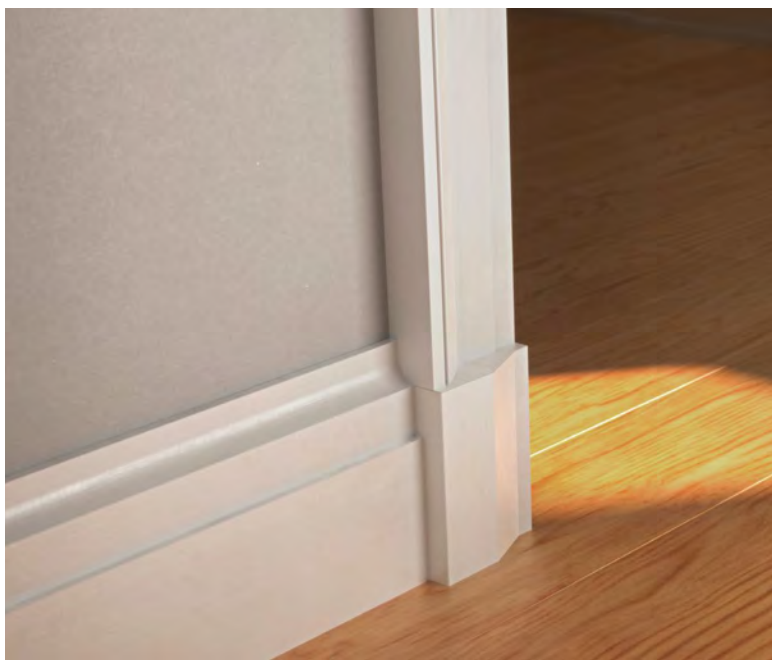



MOULDING DESIGN GUIDE
MODERN CRAFTSMAN KITCHEN

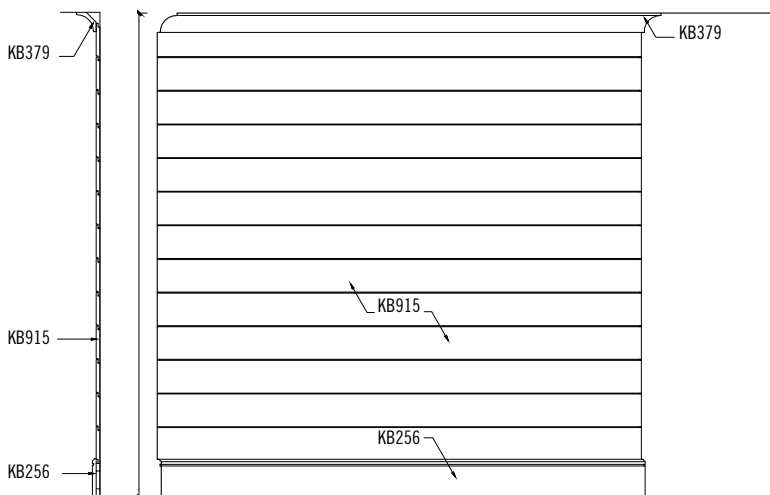

WINDOWS, DOORS, CABINETS & MILLWORK

The products featured on the following pages may be viewed in person at Kuiken Brothers Showrooms, which should be viewed as extensions of our builder, remodeler and architect customer's business. We have hundreds of windows, doors, cabinetry, moulding, architectural hardware, deck and railing on display in full room settings so that you and your customers can make quick and easy product selections. Our friendly and courteous staff will join you as you walk through the showroom, offering advice to ensure the selection process goes smoothly.



MILLWORK & CABINETRY SHOWROOMS AT KUIKEN BROTHERS



Our friendly and courteous staff will join you and your clients as you walk through the showroom, offering advice to ensure the selection process goes smoothly.

**WINDOWS ■ DOORS ■ CABINETRY
ARCHITECTURAL HARDWARE
MOULDING ■ DECKING**



TAKE A TOUR AT [KUIKENBROTHERS.COM/SHOWROOMS](https://www.kuikenbrothers.com/showrooms)



A-SERIES
WINDOWS & DOORS



Architectural Style Made Easy.

Andersen A-Series windows and patio doors combine innovative engineering with traditional craftsmanship to make any architectural style easily achieved.



Kuiken Brothers Co. Inc. features quality Andersen products

DURABLE

- Virtually maintenance-free
- Exterior finish never needs painting and won't flake, rot, blister, peel or corrode
- Exteriors are protected by a Fibrex® material and fiberglass for long-lasting* performance

ENERGY-EFFICIENT

- Weather-resistant construction for greater comfort and energy efficiency
- Variety of High-Performance Low-E4® glass options available to help control heating and cooling costs in any climate
- Many A-Series windows and patio doors have options that make them ENERGY STAR® v. 6.0 certified throughout the U.S.

BEAUTIFUL

- Eleven exterior color options and a variety of interior options
- Extensive hardware selection, grilles, between-the-glass art glass and patterned glass options



E-SERIES
WINDOWS & DOORS



Every E-Series window and door is made to your exact specifications, giving you unmatched freedom to create the home of your dreams.

- 50 standard exterior colors, 7 anodized finishes and custom colors also available
- Rich wood interiors in 10 species, 12 finish options and exotic woods also available
- Elegant shapes and monumental sizes to create dramatic window combinations
- Between-the-glass blinds, shades and grilles
- VeriLock® integrated security sensors, a feature no other windows or doors can provide



Kuiken Brothers Co. Inc. features quality Andersen products





BIG DOORS

MOVING GLASS WALL SYSTEMS



On Display Kuiken Brothers Midland Park, NJ Showroom

MULTIGLIDE™ DOOR – BIG SLIDING GLASS DOORS

HUGE OPENINGS, SEAMLESS TRANSITIONS, AND OUTSTANDING PERFORMANCE.

More than just oversized sliding glass doors, Andersen's moving glass wall systems create spectacular spaces for relaxing, entertaining, or just being. Start by framing your view, then simply open the glass that separates you from it.

- Unlimited choice of exterior colors and interior wood species
- High-performance flush bottom tracks for a seamless indoor/outdoor lifestyle
- Performance-tested sliding, folding, pivot and swinging doors
- Glass options include impact-resistant, triple pane and high-performance



LIFTSLIDE DOOR – SEAMLESS FLOOR TRANSITION



**PIVOT DOOR – UNIQUE
OPENING ARCHITECTURES**



**FOLDING OUTSWING DOOR –
CREATE A STATELY WALL OF LIGHT**



BEEFY BIFOLD DOOR – MAXIMIZE LARGE OPENINGS

BLACK EXTERIORS NOW AVAILABLE.



All Andersen® 400 Series windows and 200 Series gliding patio doors are now available with black exteriors. It's one more way Andersen provides greater flexibility than ever. **Why choose anything else?**

EXTERIOR OPTIONS



Red Rock trim with Sandtone window

Exterior Trim

For more curb appeal, add optional Andersen® exterior trim. It's available in 11 colors, so you can match or complement your window or door colors to create a variety of looks. Made of patented Fibrex® material, our trim never needs painting, and it won't fade, flake, blister, or peel no matter what the climate.*

Watch videos and use our visualizer tool to create your own look at:
andersenwindows.com/exteriortrim

Visit andersenwindows.com/warranty for details.

STYLES



2" Brick Mould
Dove Gray trim
Terratone window



3 1/2" Flat
Dark Bronze trim
White window



4 1/2" Flat
Canvas trim
Forest Green window

HEAD TRIM OPTIONS



Decorative Drip Cap



2" Cornice



3 5/8" Cornice

Kuiken Brothers Co., Inc. features quality Andersen products

INTRODUCING THE EASY CONNECT JOINING SYSTEM

The ultimate in jobsite convenience. Join large window combinations in the opening with improved performance, fewer headaches and less jobsite labor.

Makes installing window combinations a *snap!*

























50%
FEWER*
INSTALLERS NEEDED

Currently available on A Series and 100 Series.





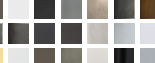
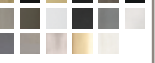









*69% of 156 builders/general contractors in a 2018 survey said they could reduce the number of installers by half using the Andersen Easy Connect joining system when comparing the installation of a 12' wide x 8' high pre-assembled window combination unit with four (4) individual 3' wide x 8' high window combination units.





	ENTRY DOORS	BIG DOORS	E-SERIES	A-SERIES
PRODUCT STATEMENT	Handcrafted Premium Wood Entry Doors	Removing Boundaries	Unlimited Possibilities to Create Your Original	Architectural Authenticity, Unparalleled Performance
PRODUCT TYPES		MultiGlide™ Doors MultiGlide Pass-Through Windows (Min RO Size: 60" x 48") Folding Outswing Doors (Max Door Size: 48" x 10") Folding Pass-Through Windows (Min RO Size: 39" x 37") Liftslide Doors (Max Doors Size: 60" x 16") Liftslide Pass-Through Windows (Min RO Size: 59 1/8" x 36") Beefy Bifold Doors Pivot Doors (Max Door Size: 60 sq. ft. glass)	Casement & Awning French Casements Push Out Casement & Awning Double-Hung (Full-Frame, Insert & Sash Kit) Monumental Single-Hung Gliding Windows Specialty Windows Bays & Bows Hinged Patio Doors (Inswing & Outswing) Gliding Patio Doors Sidelights & Transoms	Casement & Awning Complementary Casement Double-Hung Specialty Windows Hinged Patio Doors (Inswing & Outswing) Gliding Patio Doors Sidelights & Transoms Complementary Curved Top Patio Doors
MATERIALS	Wood Exterior & Interior Aluminum-Clad Wood (Aluminum Exterior/ Wood Interior)	Aluminum Wood-Clad Aluminum-Clad Wood Wood Exterior & Interior (Beefy Bifold, Liftslide and Pivot only)	Aluminum-Clad Wood (Aluminum Exterior/Wood Interior)	Wood Interior Composite Exterior
EXTERIOR COLORS	 50 Exterior Colors 7 Anodized Finishes & Custom Colors Available	 50 Exterior Colors 7 Anodized Finishes & Custom Colors Available	 50 Exterior Colors 7 Anodized Finishes & Custom Colors Available	 11 Colors
INTERIOR WOOD SPECIES		 & Custom	 & Custom	
INTERIOR WOOD FINISHES	NA	 ¹		 [†]
INTERIOR COLORS		 ²		 ^{††}
GRILLE TYPES		 ³		
HARDWARE FINISHES		 ³	 ^A	 [‡]
NOTES	[*] Wood species are available on both interiors and exteriors of the door.	¹ Interior wood finishes available for MultiGlide door only. ² Available on MultiGlide and Folding Outswing doors only. ³ Not all grille types and hardware finishes are available for every product, visit andersewindows.com for details.	^A Not all hardware styles are offered in every finish, see individual products for details.	[†] Finishes available on pine, oak and maple species only. ^{††} Additional colors are available. See your Andersen supplier for details. [‡] Not all hardware styles are offered in every finish, see individual products for details.



	400 SERIES	200 SERIES	100 SERIES
PRODUCT STATEMENT	The Windows Contractors Trust Most **	Warmth of Wood at an Uncommon Value	The Smart Alternative to Vinyl
PRODUCT TYPES	Casement & Awning Complementary Casement Double-Hung Tilt-Wash (Full-Frame & Insert) Gliding Windows Specialty Windows Complementary Specialty Bays & Bows Hinged Inswing Patio Doors Gliding Patio Doors Sidelights & Transoms Complimentary Curved Top Patio Doors	Double-Hung Tilt-Wash Gliding Windows Specialty Windows Hinged Inswing Patio Doors Gliding Patio Doors	Casement & Awning Single-Hung Gliding Windows Specialty Windows Gliding Patio Doors Sidelights & Transoms
MATERIALS	Vinyl-Clad Wood ¹ (Vinyl Exterior/Wood Interior)	Vinyl-Clad Wood ¹ (Vinyl Exterior/Wood Interior)	Fibrex® Composite Interior & Exterior
EXTERIOR COLORS	 7 Colors	 2 Window Colors 6 Patio Door Colors	 5 Colors
INTERIOR WOOD SPECIES	 ³	 ³	NA
INTERIOR WOOD FINISHES	NA	NA	NA
INTERIOR COLORS	 ³		 ⁴
GRILLE TYPES			
HARDWARE FINISHES	 ⁶	 ⁶	 ⁶
NOTES	<ol style="list-style-type: none"> Some products in this Series have alternate construction methods and materials used, see individual products for details. Not all products are offered in every color, see individual products for details. Not all products are offered in these wood species, see individual products for details. Products with black, dark bronze and Sandtone interiors have matching exteriors. Windows only. Dark bronze and black interiors are only available with dark bronze and black exteriors respectively. See your Andersen supplier for availability. Not all hardware styles are offered in every finish, see individual products for details. 		

MARVIN 
SIGNATURE[®]
COLLECTION



The Marvin Signature[®] collection offers the broadest range of product types, sizes, configurations and design options. Experience the difference in the highest level of architectural precision and beautiful aesthetics. Featuring the Ultimate and Modern product lines, the Signature collection is a hallmark of Marvin's design leadership and customer-focused innovation. Formerly Marvin Windows & Doors

A large window with a warm wood interior frame, looking out onto a lush green garden with trees and a wooden fence. A dining table with chairs and a vase of white flowers is visible in the foreground.

MARVIN 
ELEVATE[®]
COLLECTION

The **Marvin Elevate**[®] collection is a blend of remarkable design and superior strength, bringing balance to style and performance needs. Patented fiberglass exteriors stand up to all elements, outperforming and outlasting vinyl, roll-form aluminum and other fiberglass composites. Warm wood interiors add timeless beauty. **Formerly Integrity Wood/Ultrex**

A window with a white frame, looking out onto a green landscape. A black wood-burning stove is positioned in front of the window, and a small potted plant sits on a surface to the right.

MARVIN 
ESSENTIAL[®]
COLLECTION

The **Marvin Essential**[®] collection brings together design, quality, and performance in one streamlined offering. Strong, durable fiberglass exteriors and interiors are both striking and virtually maintenance-free. Simplified options provide clean lines and versatile styles making it easy to meet project demands. **Formerly Integrity All Ultrex**

Find out more at WWW.MARVIN.COM



THE MARVIN PORTFOLIO



ULTIMATE

Most extensive selection of features, options, and product types

ELEVATE

Wide range of options and product types

ESSENTIAL

Curated options and product types

MODERN

Design flexibility in a purely modern aesthetic available exclusively at Marvin Modern dealers

INTERIORS

A selection of high-quality interior materials and finishes to complement every design aesthetic

WOOD

6 species options + custom



Painted or primed



6 stains + clear coat



WOOD

Bare pine, painted Designer Black, painted White, or clear coat



FIBERGLASS

4 color options



EXTRUDED ALUMINUM

5 color options



EXTERIORS

Long-lasting, low-maintenance exteriors with best-in-class finishes for superior durability in the harshest of environments

EXTRUDED ALUMINUM

19 colors + custom



WOOD

3 species + custom



FIBERGLASS

6 color options



FIBERGLASS

6 color options



FIBERGLASS

6 color options



SIZING

Windows and doors built to your exact specifications

Standard + custom sizing for replacement, remodeling, or new construction

Custom sizing for remodeling or new construction

HARDWARE

For enhanced durability in harsh climates, some exterior hardware options are available with extra long-lasting PVD finishes

Extensive selection including Marvin Gallery Hardware

Available in 6 finish options with 2 door handle styles

Available in 6 finish options with 1 door handle style

Minimalist hardware for modern design aesthetic

COASTAL + WATERFRONT

All Marvin products are well suited for coastal and waterfront areas with special products and hardware designed for hurricane zones

Hurricane Impact Zones 3 and 4, + PG 50 Products



Hurricane Impact Zone 3, + PG 50 Products





MATERIALS	ULTIMATE	ELEVATE	ESSENTIAL	MODERN
INTERIORS				
WOOD	✓	✓		
EXTRUDED ALUMINUM				✓
FIBERGLASS			✓	
EXTERIORS				
WOOD	✓			
EXTRUDED ALUMINUM	✓			
FIBERGLASS		✓	✓	✓
PRODUCTS	ULTIMATE	ELEVATE	ESSENTIAL	MODERN
WINDOWS				
	Double Hung Single Hung Casement Awning Glider Picture Round Top Specialty Shapes Hopper Push-Out Corner	Double Hung Single Hung Casement Awning Glider Picture Round Top Specialty Shapes Hopper Push-Out Corner	Double Hung Single Hung Casement Awning Glider Picture Round Top Specialty Shapes Hopper Push-Out Corner	Double Hung Single Hung Casement Awning Glider Picture Round Top Specialty Shapes Hopper Push-Out Corner
FEATURES + OPTIONS	Casement Wash Mode Double Hung Tilt Wash Smart Home Lock Sensors Triple Pane	Casement Wash Mode Double Hung Tilt Wash Smart Home Lock Sensors Triple Pane	Casement Wash Mode Double Hung Tilt Wash Smart Home Lock Sensors Triple Pane	Casement Wash Mode Double Hung Tilt Wash Smart Home Lock Sensors Triple Pane
DOORS				
	Sliding Patio Sliding French Inswing/Outswing Pivot Scenic Multi-Slide Scenic Bi-Fold Scenic Lift and Slide Scenic Corner	Sliding Patio Sliding French Inswing/Outswing Scenic Bi-Fold Pivot Scenic Multi-Slide Scenic Bi-Fold Scenic Lift and Slide Scenic Corner	Sliding Patio Sliding French Inswing/Outswing Pivot Scenic Multi-Slide Scenic Bi-Fold Scenic Lift and Slide Scenic Corner	Sliding Patio Sliding French Inswing/Outswing Pivot Scenic Multi-Slide Scenic Bi-Fold Scenic Lift and Slide Scenic Corner
FEATURES + OPTIONS	Automated Controls Smart Home Lock Sensors Retractable Screens	Automated Controls Smart Home Lock Sensors Retractable Screens	Automated Controls Smart Home Lock Sensors Retractable Screens	Automated Controls Smart Home Lock Sensors Retractable Screens
OPTIONS				
	Divided Lites Bars with Spacer Bars without Spacer Grilles-between-the-Glass Authentic Divided Lites Glass Energy Efficient Options Decorative Sound Abatement Laminated Fire Glass (California) Turtle Glass	Divided Lites Bars with Spacer Bars without Spacer Grilles-between-the-Glass Authentic Divided Lites Glass Energy Efficient Options Decorative Sound Abatement Laminated Fire Glass (California) Turtle Glass	Divided Lites Bars with Spacer Bars without Spacer Grilles-between-the-Glass Authentic Divided Lites Glass Energy Efficient Options Decorative Sound Abatement Laminated Fire Glass (California) Turtle Glass	Divided Lites Bars with Spacer Bars without Spacer Grilles-between-the-Glass Authentic Divided Lites Glass Energy Efficient Options Decorative Sound Abatement Laminated Fire Glass (California) Turtle Glass

MODERN

THE MARVIN SIGNATURE® COLLECTION

MARVIN 

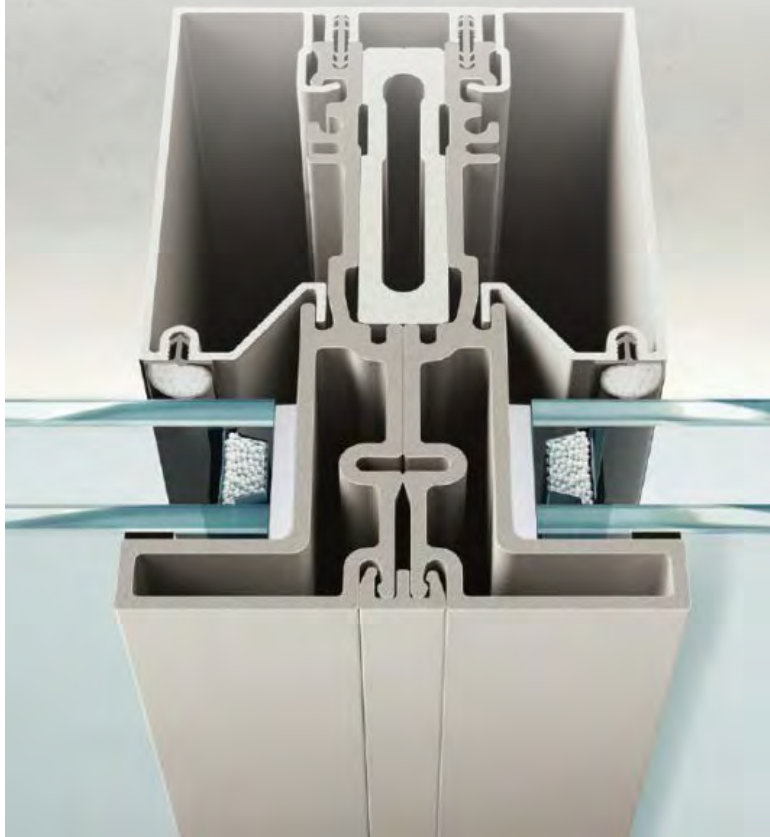

As part of the The Marvin Signature® collection, Modern brings exceptional design, performance, and customer experience together—creating a product line that meets the exacting principles and standards of true modern architecture. An innovative high-density fiberglass material, leading thermal performance, consistent narrow sightlines, and a modular system all add up to the Modern product line—a seamless approach to modern design. Available in five curated interior and exterior color designed to match your modern design.

Find out more at WWW.MARVIN.COM/MODERN

INTRODUCING THE NO LEAK
SOLAR POWERED "FRESH AIR" SKYLIGHT.



Eligible for 26%
Federal Tax Credit

Superior LoE3 Glass

Opens for
Fresh Air

Solar Powered
No wiring needed for operation

Rain Sensor
Closes automatically

VELUX[®]
Skylights



Commercial builders and developers choose Kuiken Brothers millwork specialists because we are responsive, collaborative, and communicative throughout the project. Our long term relationships with the nations most trusted millwork manufacturers ensures competitive pricing without compromising on quality or service. Contact the commercial building material experts at Kuiken Brothers today.



**LEARN
MORE**

DOORS &
ARCHITECTURAL
HARDWARE



THERMA-TRU[®] DOORS

The Most Preferred Brand in the Business™

THERMA-TRU paintable or stainable fiberglass entry doors or steel entry doors have all the benefits and none of the disadvantages of wood. Therma-Tru uses energy-efficient materials which out-perform wood, materials that don't warp or split under the most severe weather conditions. Available with many options, including the new vented sidelites. Consult a Kuiken Brothers representative on how you can find out more about Therma-Tru doors.



Looking to add a splash of color to your entryway? ThermaTru's **Smooth-Star** is the answer if the best look for your home is a smooth, paintable surface. The more attractive and durable alternative to steel, Smooth-Star fiberglass doors are ready-to-paint (no need to prime!) with crisp, clean contours. Budget friendly, with a variety of glass options available, this is your collection if you're seeking color options for your doorway.

HAND BRUSHED, FACTORY FINISHED DOORS



Reeb Finish is a division of Reeb that provides fiberglass doors and composite or solid wood frames with a factory finish. Reeb Finish Stain featuring PrismaGuard produces a unique, durable finish. It merges **the natural look and variance of real wood with the durability of fiberglass**. Once the stain is applied, **Reeb Finish Artisans skillfully hand-brush each component** of the door to enhance its deep embossments and authentic grain patterns. A dual top coat is applied to highlight the fine details and **ensures superior endurance and protection** from the elements.



Primed Stile & Rail Doors

Primed stile and rail doors are an ideal choice for homeowners seeking to add a clean look to their modern, traditional or craftsman style homes. They feature architecturally correct layouts, crisp shadow lines and highly defined panels providing a superior level of detail.

- Available 1-3/8" and 1-3/4" thickness
- Choose 3/8" or 5/8" MDF Flat Panel with Shaker or Ovolo sticking
- Select styles available in 6/8, 7/0 and 8/0 for immediate shipment



(Door Above) PR8782



PR8720



PR8782



PR8760



PR8740



PR8755



PR730F



PRF2310



PRF2302

To view the complete offering of primed stile and rail doors available from Reeb® for immediate shipment, please visit us at kuikenbrothers.com/catalogs

"EVERYONE TALKS ABOUT THE WEATHER, BUT NOBODY DOES ANYTHING ABOUT IT."

- MARK TWAIN

©2016 Simpson Door Company. All trademarks are property of Simpson unless otherwise noted. All rights reserved.



NANTUCKET® COLLECTION

DOOR 77662

10-YEAR WARRANTY WITH
NO OVERHANG REQUIRED

WATERBARRIER® TECHNOLOGY

DOOR 7506

WITH WATERBARRIER TECHNOLOGY
5-YEAR WARRANTY WITH NO
OVERHANG REQUIRED

UNTIL NOW. Give your customers the right door for any exposure.

Simpson has doors that can weather anything Mother Nature sends their way. Our WaterBarrier technology on the outside can be matched with any wood species on the inside to stop water in its tracks. And our Nantucket Collection is an all-wood door made with a modified mortise-and-tenon construction technique, creating a door that is as durable as it is beautiful.

INSPIRATION
AT YOUR DOOR®

LEARN MORE ABOUT THESE AND OTHER OPTIONS
AT SIMPSONDOOR.COM

Simpson®
Door Company



Completely Customize Your TruStile Doors

THIS EXCLUSIVE WEB-BASED SOFTWARE provides architects, designers and homeowners the ability to create and design their own custom door. New enhancements were added to allow even more flexibility when custom building a door to reflect your own personal design style.

TRUSTILE®

[Register](#) [Log in](#)

DRIVEN BY DESIGN™
Door Design Tool | My Projects
Feedback or Questions | Where to Buy

EXPORT PDF
EXPORT DXF
RESTORE DEFAULTS
CREATE AN ACCOUNT TO SAVE PROJECT

Opening Type: Swing

Leaf Count: 1 Pair

Jamb: None

Door Handing: Center Meet Pair Reverse

Artery: None

Door Beveling - Left: Bevel Meeting Side

Door Beveling - Right: None Meeting Side

Door Style: IS2160

Layout Configuration: Common Arched Pair

Door Top: Square

Panel Substitution: None

Material & Fire Rating

Material: MDF

Fire Rating: Non-rated

Dimensions

Gross Width (in): 30

Pre-Fit Width: None 1/8" 3/16" 1/4"

Net Width (in): 29 13/16

Height (in): 80

TRUSTILE® DOORS

www.trustile.com



Custom interior and exterior doors

Signature Doors design team will take your sketch or idea and turn it into reality. Their CAD department will generate a drawing of your custom unit within 24 hours in most cases. Put your "Signature" on your home with a beautiful custom decorative entryway!

www.signaturedoor.com

Start your custom door journey today at a Kuiken Brothers Showroom.

SPECIAL ORDERS
 Only call this number for
 a quote and I understand
 that it is non-refundable.
 X

lock stile width: $4\ 5/8"$
 (edge of moulding to edge of door)

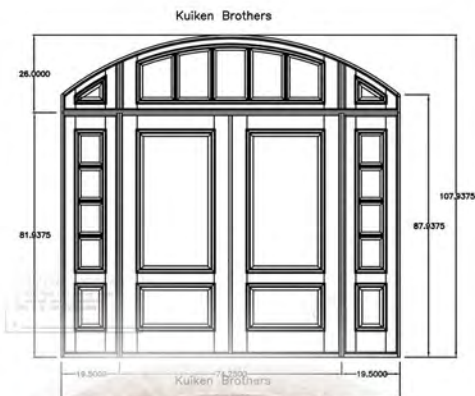

JELD-WEN[®]

WINDOWS & DOORS



AURORA

FIBERGLASS DOORS

Handcrafted for exceptional beauty and an unmatched attention to detail, JELD-WEN Aurora Custom Fiberglass exterior doors are nearly indistinguishable from solid wood.

CUSTOM

WOOD ENTRY DOORS

A unique expressions of what makes your home yours. The JELD-WEN Custom Wood exterior door combines exacting artistry with the finest materials. Craft your dreams into reality.

Get more door value with

Masonite exterior doors



Select from our vast line of traditional, contemporary, or modern designs from 1-panel to 9-panel patterns with or without decorative glass elements

more door designs

more glass styles

more value



BEFORE



 *Masonite*[®]
www.masonite.com

CS[®] CavitySliders™

The Pocket Door Experts

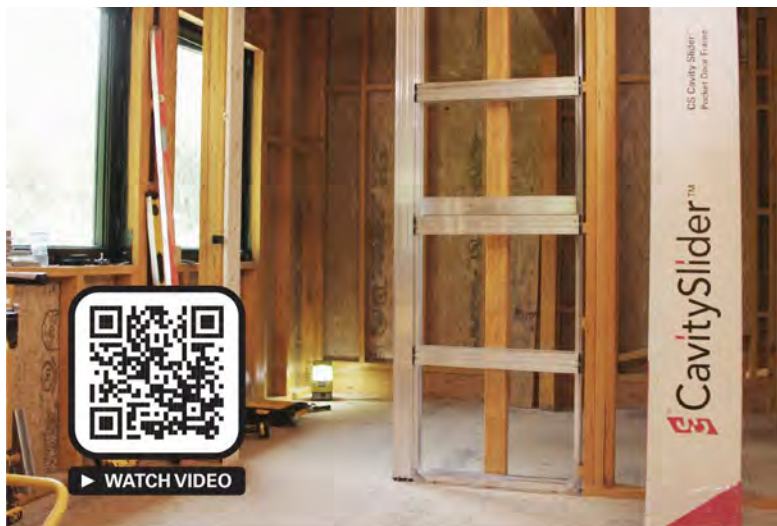

The **CS Cavity Slider's** innovative design and high-quality hardware is worlds away from the traditional pocket door system.

- Full aluminum frame for structural rigidity
- Supplied as a kitset; easy to assemble and install
- Can be cut down to size on site
- Suitable for 1-3/8" & 1-3/4" door thickness
- 500 lb weight capacity
- Soft close compatible



Learn more at cavitysliders.com



ARCHITECTURAL HARDWARE

Interior Door / Entry Door / Pocket Door / Electronic / Cabinetry



FEATURED BRANDS:

BALDWIN EMTEK JEFFREY ALEXANDER™
by Hardware Resources

OMNIA ROCKY MOUNTAIN® SCHLAGE® TK | TOP KNOBS

KEYLESS ENTRY FROM EMTEK

AVAILABLE AT ALL KUIKEN BROTHERS SHOWROOMS

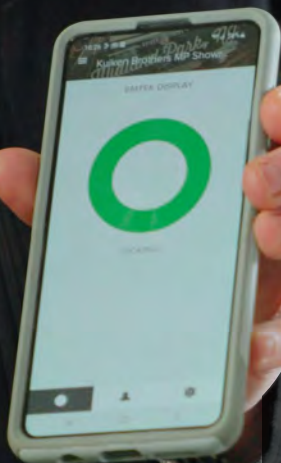

Door hardware is more than a way to open, close, and secure a space. Emték's EMPowered SMART Keypad Entry Lock offers easy and convenient keyless home security. Create your own personal security code and assign passwords for yourself, your children or for guests with ease – all from your smartphone.

VISIT A KUIKEN BROTHERS SHOWROOM AND CHOOSE FROM 5 DIFFERENT SLEEK FINISHES:



SATIN NICKEL (US15)



POLISHED NICKEL (US14)



POLISHED CHROME (US26)

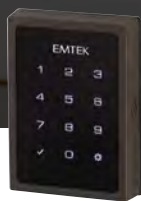

OIL RUBBED BRONZE (US10B)

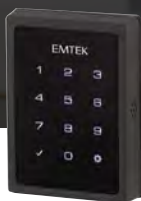

FLAT BLACK (US19)

KEYLESS DESIGN: ■ Key Free ■ One Touch Locking
Auto Re-lock ■ Manage Codes ■ Battery Back-Up

STYLISH FUNCTION: ■ Backlit Keypad ■ Universal Design
All Metal Construction ■ Motorized Action ■ Tapered Deadbolt

COMPATIBLE WITH: ■ Amazon Alexa ■ Google Assistant
Apple HomeKit ■ August App ■ Yale Access App



WATCH VIDEO



Door Handing Inside the Room

When the door opens to you and the knob is on the left, it is a left hand door.



Left Hand

When the door opens to you and the knob is on the right, it is a right hand door.

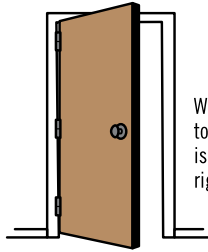

Right Hand

Door Handing Outside the Room

When the door swings open to the left, it is a left hand door.

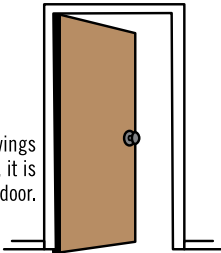

Left Hand

When the door swings open to the right, it is a right hand door.

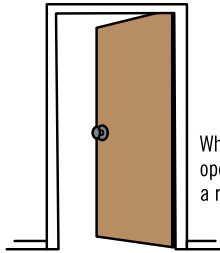

Right Hand

Interior Doors

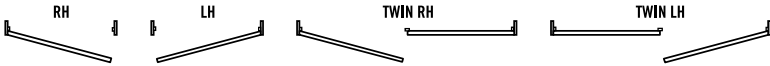

Interior Doors

Exterior Inswing Doors - Exterior Side

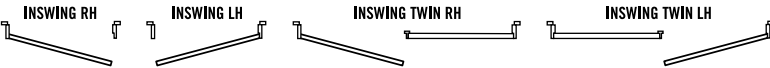

Exterior Inswing Doors - Interior Side

Exterior Outswing Doors - Interior Side

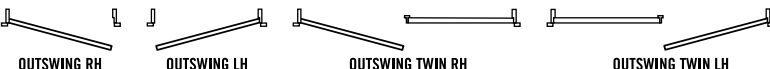

Exterior Outswing Doors - Exterior Side

*Some manufacturers, including Andersen Windows, follow hinge location to determine door swing. The above chart is intended for quick reference. Please confirm with your Kuiken Brothers representative prior to order completion.



KUIKEN BROTHERS
COMPANY INC. *Since 1912*
RESIDENTIAL &
COMMERCIAL BUILDING MATERIALS

COMMERCIAL DOORS & HARDWARE

The following pages represent products supplied through our Commercial Door & Hardware Department in Garfield, NJ. In addition, we are able to provide you with in-house modification and a UL Label shop, as well as plan take-offs and project management. We service commercial projects large and small, including light commercial, multi-family projects, institutional projects and more.





HOLLOW METAL DOORS & FRAMES

KUIKEN BROTHERS stocks and has the capability to custom fabricate a wide variety of commercial hollow metal doors and frames. Additionally, we also offer the following value added services:

- Plan Take-offs and Estimating
- Architectural Hardware Consultants on Staff
- Computerized Submittals and Shop Drawings
- Honeycomb and Insulated Door Cores
- Quick Ship Custom Orders
- Sound Rated Units Available
- Large Inventory of Stock Commercial Hardware – All Major Manufacturers

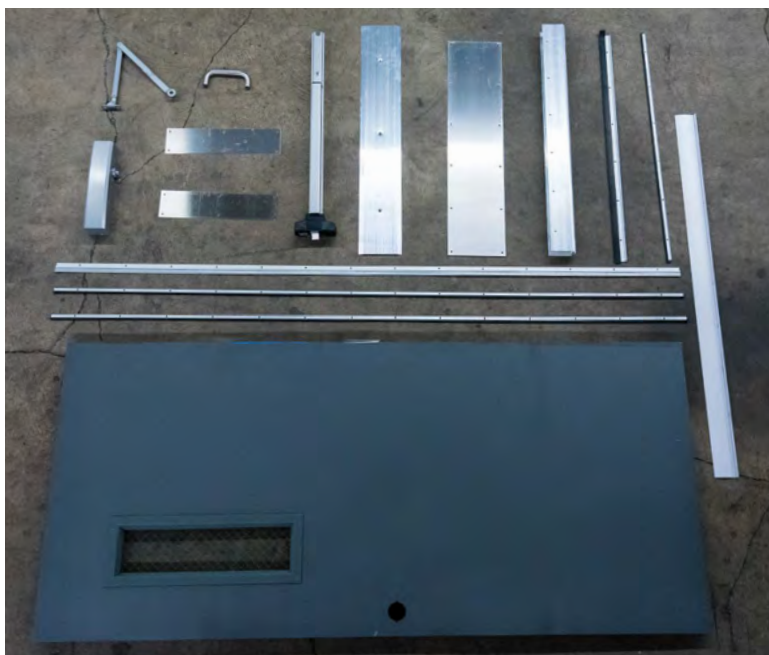



KUIKEN BROTHERS Commercial Door

Shop capabilities include:

- UL Licensed Modification Shop
- Frames Welded In-House
- Primed Painted Frames & Doors
- Lite and Louver Kit Installation
- Glass Installed in Doors

For more information call 973.772.0044



ARCHITECTURAL DOORS & HARDWARE



We have supplied commercial contractors with doors that grace the openings in many great commercial buildings throughout the area including schools, hospitals, assisted living facilities, religious institutions, office buildings, hotels and recreational facilities. Contact Kuiken Brothers Commercial Building Materials for all of your entry door needs.

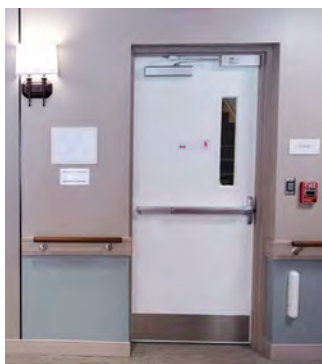

TRÜSTILE[®]
A MARVIN[®] BRAND

ASSA ABLOY

MT
INDUSTRIES

MASONITE

ALLEGION[™]



KUIKEN BROTHERS stocks a wide variety of commercial hardware products from major manufacturers such as Schlage, Falcon, and Von Duprin. We will also work with our network of suppliers, Schlage, Falcon, Von Duprin, Corbin and Yale, to meet any other request you may have. Contact the Commercial Door & Hardware department today!





STOCK HOLLOW METAL DOORS

1-3/4" FLUSH DOOR

Type	2070	2668	2670	2868	2870	3068	3070	3668	3670	4068	4070
18 Gauge	■	■	■	■	■	■	■	■	■	■	■
18 Gauge SteelCraft Location						■	■				
18 Gauge Mortise Lock Prep						■	■				
18 Gauge w/ Flushbolt ASA Prep	■	■	■			■	■				
18 Gauge w/ Cylinder Prep Insulated						■	■				
18 Gauge w/ Mortise Prep Insulated						■	■				
18 Gauge Reinforced Blank						■	■				

1-3/4" 6 PANEL DOOR

Type	3068	3070
18 Gauge w/ Cylinder Prep	■	■

Kuiken Brothers stocks and supplies a full line of quality custom and standard hollow metal doors and frames for new and retrofit construction projects in the commercial, educational and healthcare markets throughout New Jersey and New York. Our UL Licensed Modification Shop in Garfield, NJ will modify doors and frames, install visions, glass and louvers where required. We weld frames, sidelite frames and borrowed lites in-house.

**Subject to Change*

MILLWORK





Custom Curved Moulding & Millwork

Kuiken Brothers has the capability to fabricate curved and radius units from all of our stock and custom moulding options for both interior (MDF, all hardwoods) and exterior applications (Klear PVC).

Contact your Kuiken Brothers sales representative for measurement instructions.

GOTHIC

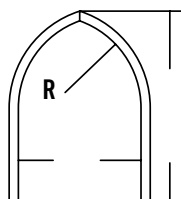

OVAL

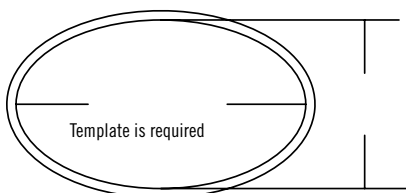

FULL CIRCLE

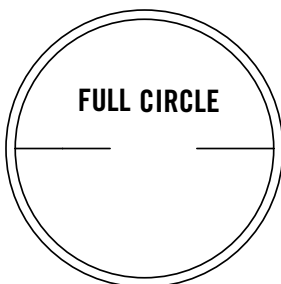

HALF CIRCLE

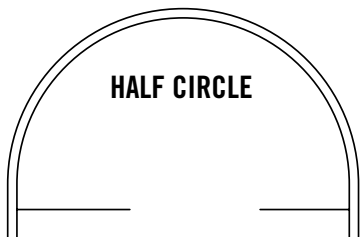

ELLIPSE

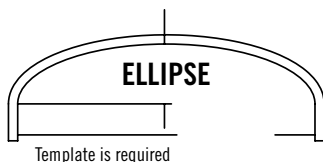

EYEBROW

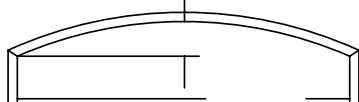

**QUARTER
CIRCLE**

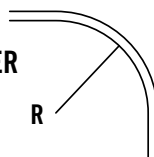



Pre-Fabricated Openings

KUIKEN BROTHERS has the ability to custom build the entire headpiece of an arched entrance as one, pre-fabricated unit, consisting of the curved jamb pre-attached to the casing, with or without keystones or capital blocks. Headpiece options include curved configurations, including elliptical, half-round or eyebrow shapes in your choice of Kuiken Brothers stock or custom mouldings.

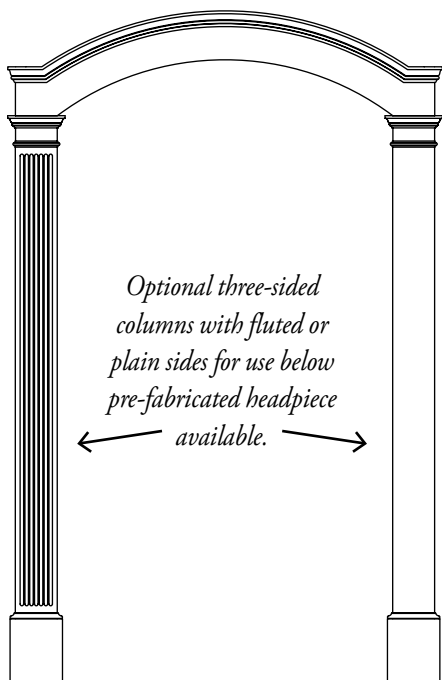
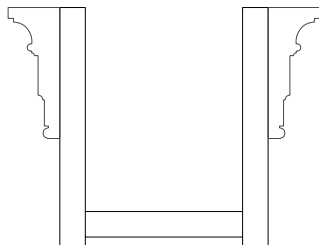
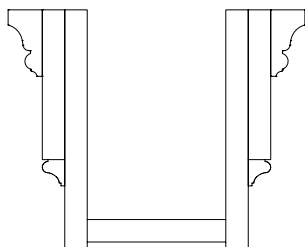
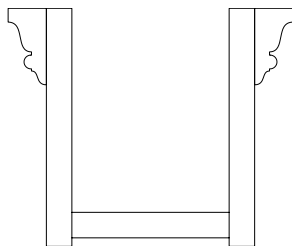

Flexible Moulding

KUIKEN BROTHERS complete collection of in-stock mouldings can be replicated in flexible moulding for curved applications where wood or MDF mouldings simply won't bend.



A P P L I C A T I O N S

- Curved Stairwells
- Radius Drywall Corners
- Bowed Windows
- Half Round Windows
- Elliptical Windows
- Arches and Arcs
- Ceiling Domes

B E N E F I T S

- Appearance of real wood
- Ease of installation – use standard woodworking equipment – cut, sand, shape and finish like wood
- No lamination defects
- Accommodate virtually any radius which is 3 times profile width or greater



MILL OUR PROFILES FROM THE HARDWOOD OF YOUR CHOICE!



- All Kuiken Brothers moulding profiles are available in most hardwood and softwood species
- No Minimum Quantities Required
- Quick Ship Program (Available within 7 business days)
- Over 60 popular moulding profiles are quickly available in poplar, red oak, maple, cherry and sapele (Mahogany)
- Custom Run Program (Available within 10-14 business days)

STOCK HARDWOOD BOARDS

Available in Oak, Cherry, Mahogany & Maple

1x4, 1x6, 1x8, 1x10, 1x12

5/4x4, 5/4x6, 5/4x8, 5/4x10, 5/4x12

STOCK HARDWOOD PLYWOOD

Available in Oak, Cherry, Mahogany & Maple

4x8-1/4, 4x8-1/2, 4x8-3/4

**Cherry Boards stocked in 1x4, 1x6, 1x8. Cherry Plywood Stocked in 4x8-3/4*



Cut It, Nail It, Glue It, Paint It or Don't Paint It. When KLEER is your solid PVC trimboard, you get everything you love about wood – the look, the feel, the timeless sense of a quality home built with traditional materials. Though unlike wood, Kleer offers an array of weather-resistant features including resistance to rot, moisture, mildew, cupping, delaminating and warping. Yet it's as workable as wood with no special tools required. Kuiken Brothers stocks all the standard board sizes and can special order sheet stock at your request. See pages 168 - 178 for the complete line of Kleer Exterior Moulding profiles.

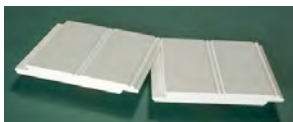
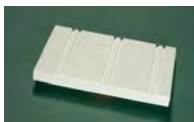

KLEER Trim	KLEER Panels	KLEER Tongue & Groove Wainscot
<i>(Reversible)</i> 18' lengths	<i>(Reversible)</i> 4' x 8' x 1/4"	<i>(Smooth Only)</i> 1/2" x 4" x 16'
Nominal Sizes Listed	4' x 8' x 3/8"	1/2" x 6" x 16'
1" x 4" 5/4" x 4"	4' x 8' x 1/2"	
1" x 6" 5/4" x 6"	4' x 10' x 1/2"	
1" x 8" 5/4" x 8"	4' x 8' x 3/4"	KLEER Preformed Corners
1" x 10" 5/4" x 10"	4' x 10' x 3/4"	<i>(Smooth or Woodgrain)</i>
1" x 12" 5/4" x 12"	KLEER Beaded Panel	5/4" x 4" - 20'
	4' x 10' x 1"	5/4" x 6" - 20'
	4' x 8' x 1/2"	

**15 YEARS.
NO CLAIMS.**



**30-YR
WARRANTY***















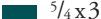

**SHIPLAP,
TONGUE & GROOVE**

-  KB914
-  KB915
-  KB908
-  KB904
-  KB906
-  WOTG



TRIM BOARDS

-  1x2
-  1x3
-  1x4
-  1x5
-  1x6
-  1x8
-  1x10
-  1x12
-  5/4 x 3
-  5/4 x 4
-  5/4 x 5
-  5/4 x 6
-  5/4 x 8
-  5/4 x 10
-  5/4 x 12

**Based on proper installation, call 888.229.7900 or see WindsorONE.com/install for details*

TruExterior®

Siding & Trim

**KUIKEN BROTHERS
NOW STOCKING:**

5/4x4 | 5/4x6 | 5/4x8

5/4x10 | 5/4x12

1x4 | 1x6 | 1x8

1x10 | 1x12

2x6

1x6 T&G

Beadboard Panel

**Phenomenal Performance.
Remarkable Workability.**



Pioneering the entirely new category of poly-ash building products, TruExterior Siding & Trim are like no other siding or trim products on the market today. Ordering phenomenal performance, remarkable workability and a lasting look, TruExterior products solve the moisture- and movement-related issues commonly seen with other exterior materials.

- Maintains dimensional stability
- No cracking or splitting from moisture
- Resists rot and termite attacks
- Installs with standard woodworking tools
- Can be painted any color
- No need to prime ends or field cuts

ROCKWELL™

WINDOW WELLS



ROCKWELL WINDOW WELLS have a stone texture that truly looks and feels like real stone. Adding great curb appeal and an aesthetically pleasing view both inside the house and outside. Our stone texture window wells also allow for more light into an otherwise dark and drab basement. Egress window well covers are also available.

Kuiken Brothers stocks Elite Egress Window Well in 60" h x 66" w and 72" h x 66" w as well as the Cascade Non-Egress Window Well in 24" h x 42" w and 36" x 42". All options come in either Gray or Tan.



HB&G manufactures architectural columns, various styles of fiberglass round and square columns, softwood and hardwood columns, mantel columns, decorative capitals, composite and wood porch posts, softwood stair parts and composite and vinyl rail systems. Combining centuries old principles and modern technology, our master craftsman and trained technicians create exquisite products and are among the industries most skilled and experienced artisans. Contact Kuiken Brothers for a current list of stock HB&G products.



INTEX MILLWORK SOLUTIONS specializes in the design and fabrication of custom PVC trim and millwork. Architects and builders rely on INTEX's strengths in both traditional workmanship and engineering technology to craft intricately detailed, high-quality millwork for distinctive homes and buildings.

The company has also innovated a line of fabricated, ready-to-install PVC window and door surrounds, and offers standard PVC millwork lengths and decorative accessories.



FYPON® MOULDED MILLWORK® is made of high density polymer. It will not rot, is insect resistant and is virtually maintenance free. Stop by any Kuiken Brothers location and explore the architectural style that most interests you, and get tips and suggestions about how to make your dream a reality. Don't forget to ask for the full line catalog.



Atlantic Premium Shutters®



With an unparalleled combination of style, craftsmanship and durability, Atlantic Premium Shutters let you create a portrait that's as subtle or bold as you wish. Our fully functional and operable shutters are architecturally correct and historically accurate. With details like open louvers and period-inspired working hardware, Atlantic shutters offer an exceptional product for discerning homes. Made-to-order for your windows, hand-assembled and hand-sanded, Atlantic Premium Shutters fuse time-honored design with reliable integrity. These color-rich shutters will not crack, split, rot, peel or flake.

WWW.ATLANTICPREMIUMSHUTTERS.COM



SOUTHERN SHUTTER COMPANY manufactures quality wood products using high-grade materials and fine craftsmanship. Though our production facility is fully equipped to produce precision-cut wood components in high volume, we have never abandoned the hands-on approach to quality construction. Each piece is carefully fitted by a Southern Shutter craftsman.



CELLWOOD® PREMIER™ & SHUTTER-CRAFT™ combine the elegant looks of wood and the long-lasting beauty of durable vinyl shutters. These shutters are available in both raised panel and classic open louvered designs. Wood Blinds are also available in either raised panel or louver; interior or exterior grade; and can be custom made to fit any opening. Interior shutters have the options of adjustable louvers and fabric frames. All shutters can be ordered in various sizes and colors. Since shutters have to be ordered, talk to your Kuiken Brothers representative for more information.

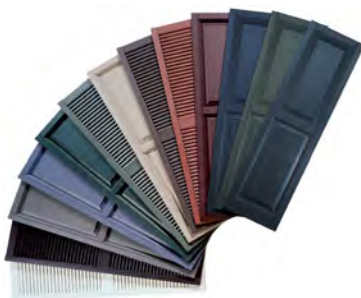



THE SUPERIOR

- 300 lb duty rating - 350 lb duty rating (Superior Plus)
- 1x5 Frame and Stringer
- 1x6 Tread
- Two Strong Metal Handrails

THE ATLAS

- 250 lb duty rating
- 1x4 Frame and Stringer
- 1x4 Tread
- One Strong Metal Handrail

THERMOBLOC

- 2 1/4" thick insulated R-10 door
- U-Factor of .10, R-Value of 10.0 (entire unit)
- Incorporates Q-Lon smoke rated weather-stripping
- Exterior grade door frame
- 350 lb duty rating (Wood Models)
- 375 lb duty rating (Aluminum Models)

THE TITAN

- 375 lb duty rating
- Aluminum sections
- Heavy duty galvanized steel hardware with "Safety Edge"
- Adjustable Foot Support with rubberized foot pads



The Titan

The Atlas

KITCHEN & BATH
CABINETRY



KITCHEN & BATH CABINETRY FOR BUILDING PROFESSIONALS AND HOMEOWNERS

Kuiken Brothers Kitchen & Bath has the experienced designers and wide range of cabinet options to fit your budget and time frame.

GET YOUR
Kitchen & Bath
RIGHT WITH KUIKEN BROTHERS
VISIT OUR KITCHEN & BATH SHOWROOMS



VISIT OUR SHOWROOMS – SCHEDULE A JOBSITE VISIT

www.kuikenbrothers.com/kitchens

EMERSON, NJ

Tel (201) 705-5804
246 Kinderkamack Rd.
Emerson, NJ 07630

SUCCASUNNA, NJ

Tel (973) 968-7700
31 Route 10 East,
Succasunna, NJ 07876

WANTAGE, NJ

Tel (973) 875-5106
175 Route 23,
Wantage, NJ 07461

WARWICK, NY

Tel (845) 986-2255
33 South Street
Warwick, NY 10990



EXPERIENCED DESIGNERS



SHOWROOMS



20/20 CAD DRAWINGS



SELECTIONS TO FIT WITH
YOUR SCHEDULE & BUDGET



DELIVERY TO YOUR JOBSITE



Kuiken Brothers' Succasunna, NJ Kitchen & Bath Cabinetry Showroom

CUSTOM CABINETRY OPTIONS

Our full custom cabinets are made to order. Custom door styles, finishes, sizes and more. This is our best series and offers more flexibility. Longer lead times and the cost is the highest of the group. When a customer wants to achieve that custom look, we recommend our Mouser line.

FEATURED CUSTOM CABINETRY BRAND:

Mouser Cabinetry



Kuiken Brothers Kitchen Cabinetry Ridgewood, NJ

SEMI-CUSTOM CABINETRY OPTIONS

Our semi-custom line, also referred to as "Made to Order," offers a wide range of door styles and finishes. These offer many of the options and amenities that a fully custom line offers, at a reduced price. Typical lead times on these lines are 5-7 weeks. You can find semi-custom cabinetry options from Mouser, Bertch Bath and Shiloh.

FEATURED SEMI-CUSTOM CABINETRY BRANDS:

Mouser Cabinetry
*shiloh*TM
C A B I N E T R Y



Kuiken Brothers' Emerson, NJ Kitchen & Bath Cabinetry Showroom

STOCK CABINETRY OPTIONS

With a general 2 week lead time, this offering makes them our most convenient and affordable series. Even though we call them "stock" there are still many different door styles and options to choose from. Our primary "stock" cabinet lines are FabuWood and Merillat.

FEATURED STOCK CABINETRY BRAND:



fabuwood®



Merillat.

DIMENSIONAL LUMBER

#2 & Better Green Doug Fir
Pressure Treated Lumber
Fire Retardant Lumber

ENGINEERED LUMBER

Boise Cascade AIS/ BCI I-Joist
Boise Cascade Versa-Lam
Boise Cascade Rim Board
Boise Cascade VersaStud
Engineered Studs
Roof & Floor Trusses
Wall Panels

BOARDS, PATTERN

& SPECIALTY LUMBER

Kleer PVC Boards
Windsor One Primed Pine
TruExterior Trim & Siding
#2 & C&Btr White Pine
STD & BTR & A&Btr Cedar
Utility & Btr Spruce Boards &
Bridging
Oak, Cherry, Poplar, Maple and
Sapele Mahogany Hardwoods
Pattern Boards in Pine & Cedar
Red Cedar Shakes & Shingles
White Cedar Undercourse
Primed Fiberboard
OSHA Approved Scaffold Planks
Cedar Closet Lining

PLYWOOD & PANELS

AC Plywood
AB Marine Plywood
CD Fir Sheathing
MDO Panels
Square Edge Underlayment
3/4" T&G Fir Underlayment
Fir T-111 Panels
SYP Plybead
MDF Beadboard
Patriot RevBead & RevPanel
Beadboard
OSB (Oriented Strand Board)
Premium OSB Underlayment
Sheathing
Kleer PVC Panels
Melamine Shelving
Lightweight Fiberboard Panels
Fire Retardant CD
CCA Treated Underlayment
Lauan & Bending Lauan Plywood
Oak, Cherry, Maple & Sapele
Mahogany Plywood
Prefinished Maple Plywood
Domestic & Imported Birch Plywood
Hardboard & Pegboard Panels
Homasote Panels
Sound Deadening Boards

FLOORING

Iron Woods IPE Porch Flooring
Aeratis PVC Flooring
Meranti Porch Flooring

Fir Porch Flooring & Stepping (FJ & Solid)
Oak Flooring & Stepping (#1, Select)
Pine Flooring & Stepping (C Select)

WINDOWS, DOORS & MISCELLANEOUS MILLWORK

Andersen Windows & Doors
Andersen Architectural Collection
(A-Series, E-Series)
Marvin Signature Windows & Doors
Marvin Elevate & Essential Windows
& Doors
Velux Skylights
Interior Doors - TruStile, REEB
Millwork, Simpson
Primed Stile Rail Doors
Exterior/ Entry Doors - KML,
ThermaTru,
JELD-WEN, Signature Door
Door Slabs & Prehung Doors
Commercial Steel & Hollow Metal
Doors
Stair Parts
Marwin Attic Stairs
Shutters
HB&G Columns & Porch Posts
Larson Storm Doors

DECKING PRODUCTS

Trex Transcend Decking
Iron Woods Ipe & Garapa Sustainable
Tropical Hardwoods
Iron Woods Ipe Deck Tiles
Siberian Larch
Cedar Decking
Premium Pressure Treated Decking
Meranti Decking
Lattice Panel
Deck Accessories

RAILING SYSTEMS

Trex Transcend Rail
Trex Signature Rail
Trex Lighting
RDI Endurance & Rail
Feeney CableRail & DesignRail
Pressure Treated Railing
Cedar Railing

EXTERIOR BUILDING MATERIALS

DuPont Tyvek Homewrap/Weatherization
System
Vycor Plus
Henry Blueskin VP100
Nichigo G-Tapes
Quickcrete Concrete Mixes
Lally Columns
Reinforcing Rods & Wire
Fiber Form Tubes
Rockwell Window Wells

HARDWARE & FASTENERS

Schlage, Baldwin, Emtek, Rocky
Mountain
Door Hardware

Commercial Hardware
Nails, Coil Nails, Screws
Simpson Strong-Tie
FastenMaster
Caulks, Sealants, Fillers
Power and Hand Tools

MOULDING

450+ Stock Profiles
Flexible, Curved & Radius Moulding
Primed Finger Joint Poplar Moulding
Primed Finger Joint Pine Moulding
Ultralite MDF Moulding
Oak, Poplar, Cherry, Maple, Sapele
Mahogany Moulding
Custom Moulding
Kleer PVC Moulding
Corner Blocks & Plinth Blocks

KITCHEN & BATH CABINETRY

Stock, Semi-Custom, Full Custom Options
In-House Designers
Countertops

*Kuiken Brothers Cabinetry Showrooms:
Emerson, NJ, Succasunna, NJ,
Wantage, NJ, Warwick, NY*

INTERIOR BUILDING MATERIALS

Drywall
Certainteed SilentFX
Shaftwall Panels
PermaBase Tile Backer
Tile Backer
Steel Studs 25, 20, 18 Gauge
Fiberglass Insulation
Rockwool Mineral Wool
Dow Grey Panels
Tuff-R Insulation
Certainteed Ceiling Tile & Grid
FRP Panels & Accessories

COMMERCIAL BUILDING MATERIALS

*In-stock at our Garfield, NJ and
Succasunna, NJ Locations*

Ceiling Systems
Suspension Systems
Drywall
Joint Compounds
Metal Studs
Insulation
Wall Panels
Homasote
Fasteners & Adhesives
Boom Truck Services (Up to 8 story)
**COMMERCIAL DOORS, FRAMES
& HARDWARE**
Hollow Metal Doors & Frames
Wood Doors (Various Veneers & Finishes)
Commercial Hardware (ASSA ABLOY,
Schlage, Falcon, Von Duprin)

SPECIAL ORDERS

If you don't see it here, just ask. We
have a strong network of suppliers and
can source just about anything.



ORDERING

KUIKEN BROTHERS MOULDING PROFILES

PRICING & ORDERING: For local projects, contact any location listed on the back of the catalog. For out-of-state inquiries, call (201) 652-1912. Inquiries can be sent to info@kuikenbrothers.com or through our website www.kuikenbrothers.com/moulding

PICK-UP ORDERS: Most profiles are in-stock at all locations. KB Classical & Modern Craftsman Poplar Moulding in-stock in Emerson, Fair Lawn, Newark, Succasunna. Please call to confirm.

DELIVERY: Generally speaking, orders received within a 50 mile radius of a Kuiken Brothers location will be delivered on our own vehicles. All others will be shipped via partner carrier. Minimal shipping & handling fees may apply where applicable.

FLEXIBLE MOULDING: All Kuiken Brothers Moulding profiles can be run in Flexible Moulding for arches, surrounds and curved wall, baseboard and crown moulding applications. Please allow 2-3 week lead time. There are no knife charges for stock profiles.

CUSTOM SPECIES: All Kuiken Brothers stock moulding profiles can be custom run in the species of your choice. Minimal set-up fees may apply.

RETURNS: If we are able to pick up the material on our own vehicle, or if the customer is able to return it to our facility, a 20% re-stocking fee may be charged assuming the material is in good condition.

PRODUCT SAMPLES: Complimentary product samples of our in-stock moulding profiles are available. E-mail info@kuikenbrothers.com or call (201) 652-1912 with the profile number.

CAD FILES: Download all Kuiken Brothers' Moulding profiles in DWG, DXF and PDF format from kuikenbrothers.com/moulding

CATALOG REQUESTS: Copies of our Full Line Moulding, Classical Moulding & Modern Craftsman Moulding Catalogs can be picked up at any of our locations or ordered through our website.

T H A N K Y O U

for considering Kuiken Brothers as your supplier. Whether it's for lumber, doors, windows, trim, millwork, kitchen cabinets, hardware, drywall or acoustical ceilings, Kuiken Brothers has it all. Currently we have five locations with rail siding which permits us to offer you the best quality lumber at competitive pricing, direct from the mills. We value the relationships we have forged over the years and welcome an opportunity to earn your business and be able to keep you as a life-long customer. Please call or visit any of our locations and experience the difference Kuiken Brothers can make in your business.

While we have made every effort to portray each item in this catalog as accurately as possible, it may be that slight variations could occur, or that certain items may be discontinued. Always check current availability with a Kuiken salesperson.



HEADQUARTERS

FAIR LAWN, NJ
6-02 Fair Lawn Avenue | Tel: 201-796-2082

RESIDENTIAL BUILDING MATERIALS

FAIR LAWN, NJ
6-02 Fair Lawn Avenue | Tel: 201-796-2082

EMERSON, NJ
246 Kinderkamack Road | Tel: 201-262-6666

MIDLAND PARK, NJ
145 Lake Avenue | Tel: 201-652-1000

WANTAGE, NJ
175 Route 23 | Tel: 973-875-5106

SUCCASUNNA, NJ
33 Route 10 East | Tel: 973-968-7700

ROSELAND, NJ
14 Eisenhower Parkway | Tel: 973-226-5700

WARWICK, NY
33 South Street | Tel: 845-986-2255

NEWARK, NJ
500 Doremus Avenue | Tel: 973-638-7200

KITCHEN CABINETRY SHOWROOMS

EMERSON, NJ
235 Kinderkamack Road | Tel: 201-705-5804

SUCCASUNNA, NJ
31 Route 10 East | Tel: 973-968-7700

WANTAGE, NJ
175 Route 23 | Tel: 973-875-5106

WARWICK, NY
33 South Street | Tel: 845-986-2255

COMMERCIAL BUILDING MATERIALS

GARFIELD, NJ
485 River Drive | Tel: 973-772-0044

SUCCASUNNA, NJ
33 Route 10 East | Tel: 973-968-7700

EMERSON, NJ
246 Kinderkamack Road | Tel: 201-262-6666

NEWARK, NJ
500 Doremus Avenue | Tel: 973-638-7200

OUT-OF-STATE INQUIRIES

If you are ordering outside of NJ or NY,
please call 201-652-1912

www.KuikenBrothers.com
email: info@kuikenbrothers.com